

**U.S. Department of Housing and Urban Development  
Office of Policy Development and Research**

**STEEL FRAMED RESIDENTIAL  
CONSTRUCTION: DEMONSTRATION  
HOMES**

# **Steel Framed Residential Construction: Demonstration Homes**

**May 1995**

Prepared for:

**U.S. Department of Housing and Urban  
Development  
Office of Policy Development and Research**

Washington, D.C.

Cooperative Agreement H-5932

Prepared by:

**NAHB Research Center**  
Upper Marlboro, Maryland

## **Notice**

The U.S. Government does not endorse products or manufacturers. Trade or manufacturers' names appear herein solely because they are considered essential to the subject of this report.

The contents of this report are the views of the contractor and do not necessarily reflect the views or policies of the U.S. Department of Housing and Urban Development or the U.S. Government.

## Foreword

Recent materials advances, technical development, availability concerns, and economic uncertainty have prompted homebuilders to examine alternatives to traditional framing materials and methods. Although the alternatives have existed for some time, builders continue to use traditional materials. In many instances, their hesitancy can be attributed to a lack of information that will guide them in using alternative construction materials.

In response to heightened interest, the U.S. Department of Housing and Urban Development (HUD) commissioned a review of available structural materials for homebuilding. The results, *Alternatives to Lumber and Plywood in Home Construction*, were published in 1993 and identified several promising materials. Further study results released in 1994 (*Alternative Framing Materials in Residential Construction: Three Case Studies*) provided insight into the installed cost of several systems.

HUD is continuing to research new materials. This report, *Steel Framed Residential Construction: Demonstration Homes* provides builders with practical information and experience, based on the actual construction of two steel framed homes. Construction of these houses was supervised by experienced steel framers, as many participants had little or no experience with that type of framing. The information presented accurately describes the steel framing process and the way the framing can be incorporated into homebuilding. It will play a vital role in the Departments' cooperative effort with the homebuilding and steel industries to develop cost-effective, prescriptive methods for steel framed homes.

I hope this report will help guide builders in the use of this promising new technique, enhancing housing affordability and promoting healthy competition in the optimal use and preservation of our natural resources.

Michael A. Stegman  
Assistant Secretary for Policy  
Development and Research

## **Acknowledgements**

This report was prepared by the NAHB Research Center under a cooperative agreement with the U.S. Department of Housing and Urban Development (HUD). The principal author was William R. Farkas, P.E. with technical support provided by Kevin Bielat. Mark Nowak and Jay H. Crandell, P.E. provided technical review.

The following manufacturers and individuals are recognized for their contributions to this project: Black and Decker Corp., Dale-Incor, Grabber, Quick Drive, and ResTek (Bruce Ward).

Special thanks is given to William Freeborne of the U.S. Department of Housing and Urban Development (Office of Policy Development and Research) for technical input and guidance, Mark E. Tipton for providing one of the demonstration homes, and Janice Duncan for administrative support.

# Contents

LIST OF FIGURES .....	ii
EXECUTIVE SUMMARY .....	v
INTRODUCTION .....	1

## PART I: DEMONSTRATION HOME 1

BACKGROUND .....	3
OBSERVATIONS .....	9
Planning and Materials .....	9
Tools .....	9
Floor Framing .....	10
Wall Framing .....	13
Roof Framing .....	14
Utility Installation .....	14
Architectural Details .....	17
Participant Perceptions .....	21

## PART II: DEMONSTRATION HOME 2

BACKGROUND .....	23
OBSERVATIONS .....	25
Planning/Materials .....	25
Tools .....	25
Fasteners .....	27
Floor Framing .....	28
Exterior Walls .....	31
Roof Trusses .....	38
Interior Walls .....	41
Utility Installation .....	41
Field Punched Holes .....	46
CONCLUSIONS .....	49
APPENDIX - Cut List .....	51

## List of Figures

Figure 1.	Basement floor plan	4
Figure 2.	First floor plan	5
Figure 3.	Second floor plan	6
Figure 4.	Exterior view of house	7
Figure 5.	Basement walls and floor joists	10
Figure 6.	Top view of beam connection	11
Figure 7.	Bottom view of beam connection	11
Figure 8.	Floor sheathing on joists	12
Figure 9.	View of floor joists	12
Figure 10.	Installation of basement walls	13
Figure 11.	Metal strapping	14
Figure 12.	Plumbing detail	15
Figure 13.	Electrical box	16
Figure 14.	Electrical wires	16
Figure 15.	Open foyer	17
Figure 16.	Master bedroom	17
Figure 17.	Master bathroom	18
Figure 18.	Dining room	18
Figure 19.	Arches in great room	19
Figure 20.	Detail of curved framing	19
Figure 21.	Great room	20
Figure 22.	Detail of great room	20
Figure 23.	Floor plan	24
Figure 24.	#8 Wafer-head screw	27
Figure 25.	#10 Hex-head screw	27
Figure 26.	Screw gun grip	28
Figure 27.	Floor joist connection	29
Figure 28.	Floor joist, interior bearing detail	29
Figure 29.	Magazine-fed screw gun with extension	30
Figure 30.	Stud and track connection	31
Figure 31.	Wall with aligned holes	32
Figure 32.	I-beam header	33
Figure 33.	Box-beam header	33
Figure 34.	Window opening	34
Figure 35.	Door opening	35
Figure 36.	Panelized wall attachment	36
Figure 37.	Plywood wall bracing	36
Figure 38.	Steel strap x-bracing	37
Figure 39.	Sheet steel wall bracing	37
Figure 40.	Scissors truss	38
Figure 41.	Howe truss	38
Figure 42.	Truss panelization jig	39
Figure 43.	Bracing and leveling of gable-end truss	39

Figure 44.	Setting interior truss .....	40
Figure 45.	Hip roof rafters .....	40
Figure 46.	Plumbing grommet .....	41
Figure 47.	Placing universal grommet .....	42
Figure 48.	Securing universal grommet .....	42
Figure 49.	Installation of metal single gang box .....	43
Figure 50.	Cable secured through punchout .....	44
Figure 51.	Cable secured along stud .....	45
Figure 52.	Wire tie with self-adhesive plate .....	46
Figure 53.	Punchout tool .....	47



## EXECUTIVE SUMMARY

With sponsorship provided by the U.S. Department of Housing and Urban Development, the NAHB Research Center coordinated two demonstration projects to practically evaluate the use of steel framing in residential construction. The demonstrations consisted of a 7,500 square-foot (697 m<sup>2</sup>) custom home in Raleigh, North Carolina and a 720 square-foot (66.9 m<sup>2</sup>) home at the NAHB Research Center in Upper Marlboro, Maryland. This report presents observations and experiences from those sites.

The Raleigh project (Demonstration Home 1) provided “hands-on” training in the use of steel framing for the local home construction industry. The custom design of this home featured some unique aspects of steel framing. However, the project took longer than expected because of construction delays related to the coordination of the steel framing design and construction of the home, among other factors specific to this demonstration project.

Construction personnel at the Raleigh project realized a need for prescriptive steel framing guidelines to streamline the construction process. Several delays and difficulties were realized during construction (and during the plan review process) that complicated even minor field changes by requiring engineering consultation. These problems increased direct costs, including the engineer’s and field personnel time, and indirect costs resulting from delays to the project schedule.

The Maryland project (Demonstration Home 2) was used to conduct a practical assessment of a variety of details used in steel framing for a relatively simple house. The construction details addressed in-line framing procedures, two types of headers for doors and windows, three methods of wall bracing, two types of trusses, and several other common framing practices for wall, floor, and roof assemblies.

Demonstration Home 2 demonstrated the importance of planning and organization when using steel framing. Steel framing members were ordered pre-cut to specific lengths, minimizing field cutting and assembly time by use of a “cut-list”. The importance of proper bundling, labeling, handling and jobsite staging of materials was also demonstrated for efficient use of steel framing. In addition, the ability to efficiently panelize the construction of walls and trusses using steel framing was demonstrated.

A major tool manufacturer participated in Demonstration Home 2. Their participation permitted the demonstration and application of a variety of currently available tools, some just entering the market. In return, the manufacturers received feedback on tool design and suitability.

The participants in the demonstration homes learned the value of hands-on training and experience in overcoming the “learning curve” associated with steel framing. With experience and the proper tools, steel framing was found to be an effective alternative to conventional homebuilding practices by participants at both demonstration projects.

## INTRODUCTION

In 1993 and 1994, the NAHB Research Center produced two reports for the U.S. Department of Housing and Urban Development (HUD) describing the potential for several alternative structural materials in the construction of homes<sup>1</sup>. These reports identified steel as a material with significant potential to overcome technical, regulatory, and economic barriers associated with the home construction industry in the United States.

As a result of previous findings and to compliment the development of prescriptive construction guidelines (also sponsored by HUD), two demonstration projects were undertaken to practically evaluate the use of steel as an alternative framing material for homes. The demonstrations provided an opportunity for participants and observers to experience steel framing and improve their understanding of steel-frame construction.

Light-gauge steel framing materials were used exclusively to construct the two demonstration homes. The basic steel members were of two types—a C-shape and a U-channel or track—formed from galvanized sheet steel by a process known as cold-forming. The cold-formed steel members were supplied by local manufacturers and distributors of light-gauge steel building products.

This report documents the experience gained at these demonstration projects in two parts. In Part I of this report, observations from the construction of a large, custom home are presented. In Part II, the experience of constructing a simple, affordable-style home is documented. Conclusions are provided at the end of the report based on the findings for both demonstration projects.

---

<sup>1</sup> *Alternatives to Lumber and Plywood in Home Construction*, HUD-1409-PDR dated August 1993; *Alternative Framing Materials in Residential Construction: Three Case Studies*, HUD-1496-PDR dated October 1994.

## **PART I: DEMONSTRATION HOME 1**

### **BACKGROUND**

Demonstration Home 1 was a 7,500 square-foot (697 m)<sup>2</sup> two-story custom house with a full finished basement near Raleigh, North Carolina. This large, custom home provided an opportunity to evaluate steel framing in many different construction details. Floor plans of the home are shown in Figures 1 through 3.

The North Carolina site presented several regional conditions that make steel framing a particularly attractive alternative, namely:

- a relatively mild climate which reduces the initial cost impact of thermal design concerns;
- a fast growing area which is receptive to new and advanced technology; and,
- well-trained residential framers.

The first site visit was made on August 16, 1994. The framing crew included:

- three framers with combined experience of more than 40 years using cold-formed steel framing for residential construction;
- a sales representative for the steel manufacturer/distributor who was participating in a weekly rotation of staff for hands-on training;
- a framing supervisor for the builder who had exclusively framed with wood; and,
- a part-time builder who had just moved to the Raleigh area and had volunteered his time to gain experience with steel.

A second site visit occurred on September 23, 1994. At this time framing of the structure was well underway. The first- and second-story exterior walls as well as the first- and second-floor joists and subflooring were complete. Arched ceilings on the first-story were in the process of being framed.

The third site visit was on December 14, 1994 (about 16 weeks after the first visit). The framing was complete and the trades were roughing-in electrical and plumbing services. At this time, the exterior looked the same as a fully-sheathed, wood-framed house (Figure 4).

**DEMONSTRATION HOME 1 - BACKGROUND**

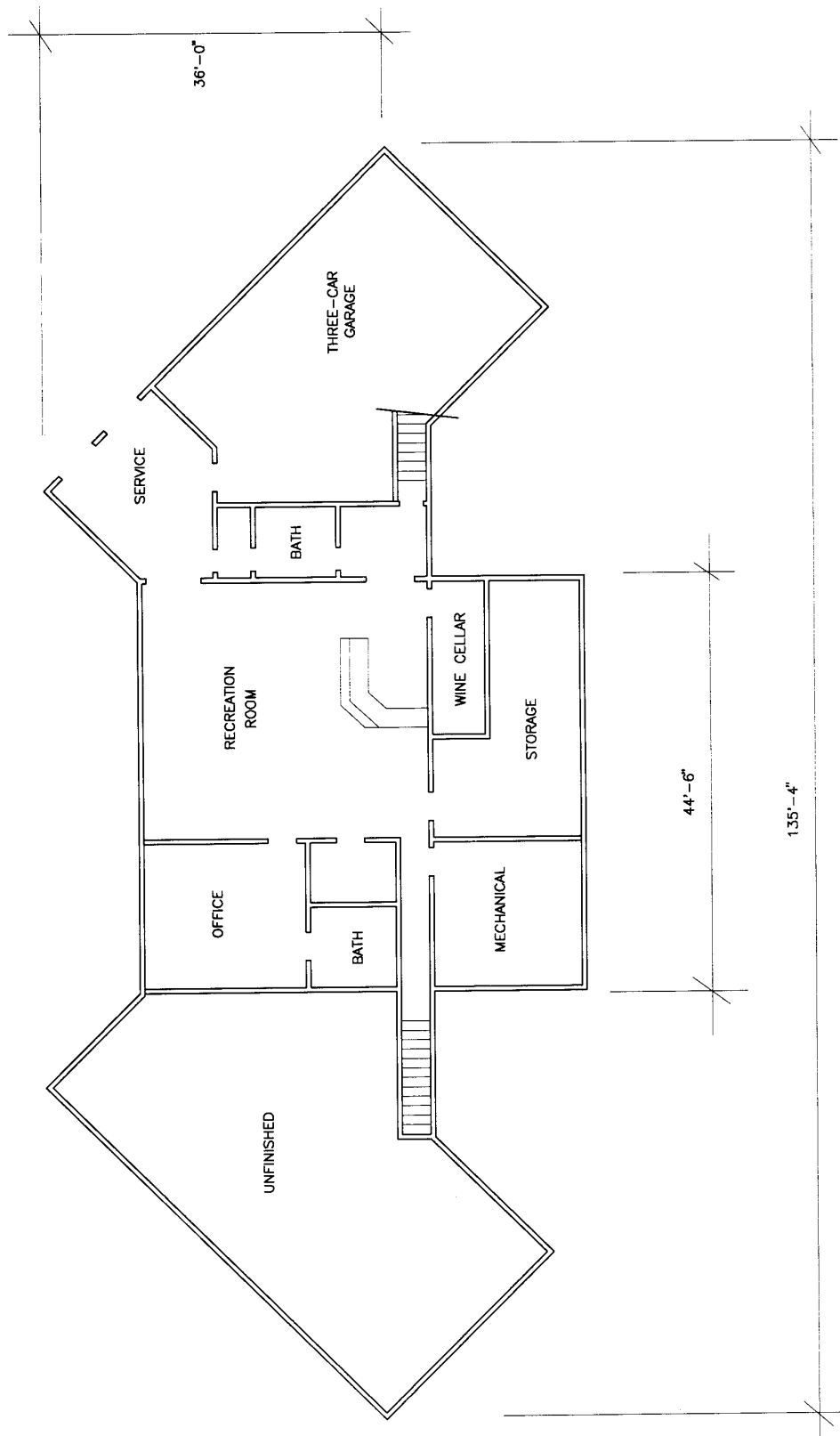

**Figure 1 - Basement Floor Plan**

DEMONSTRATION HOME 1 - BACKGROUND

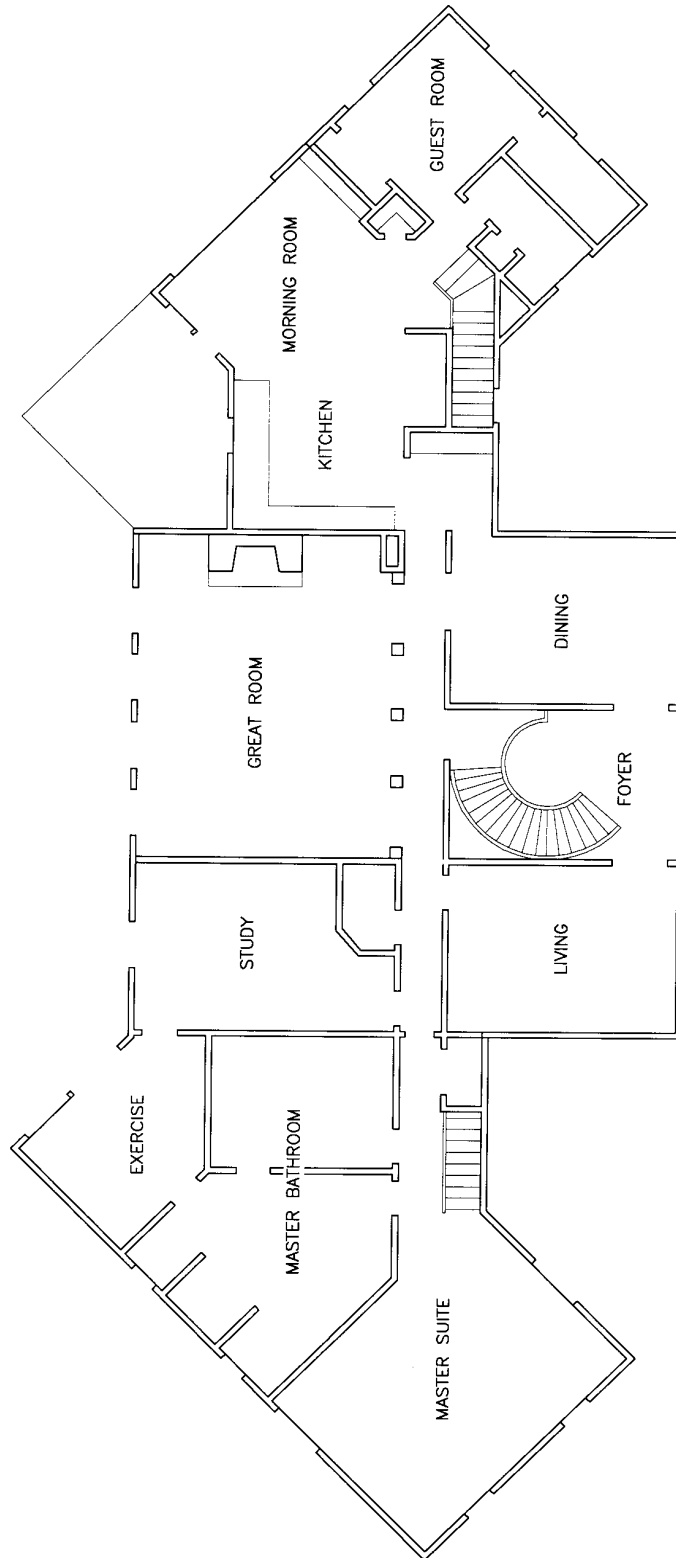
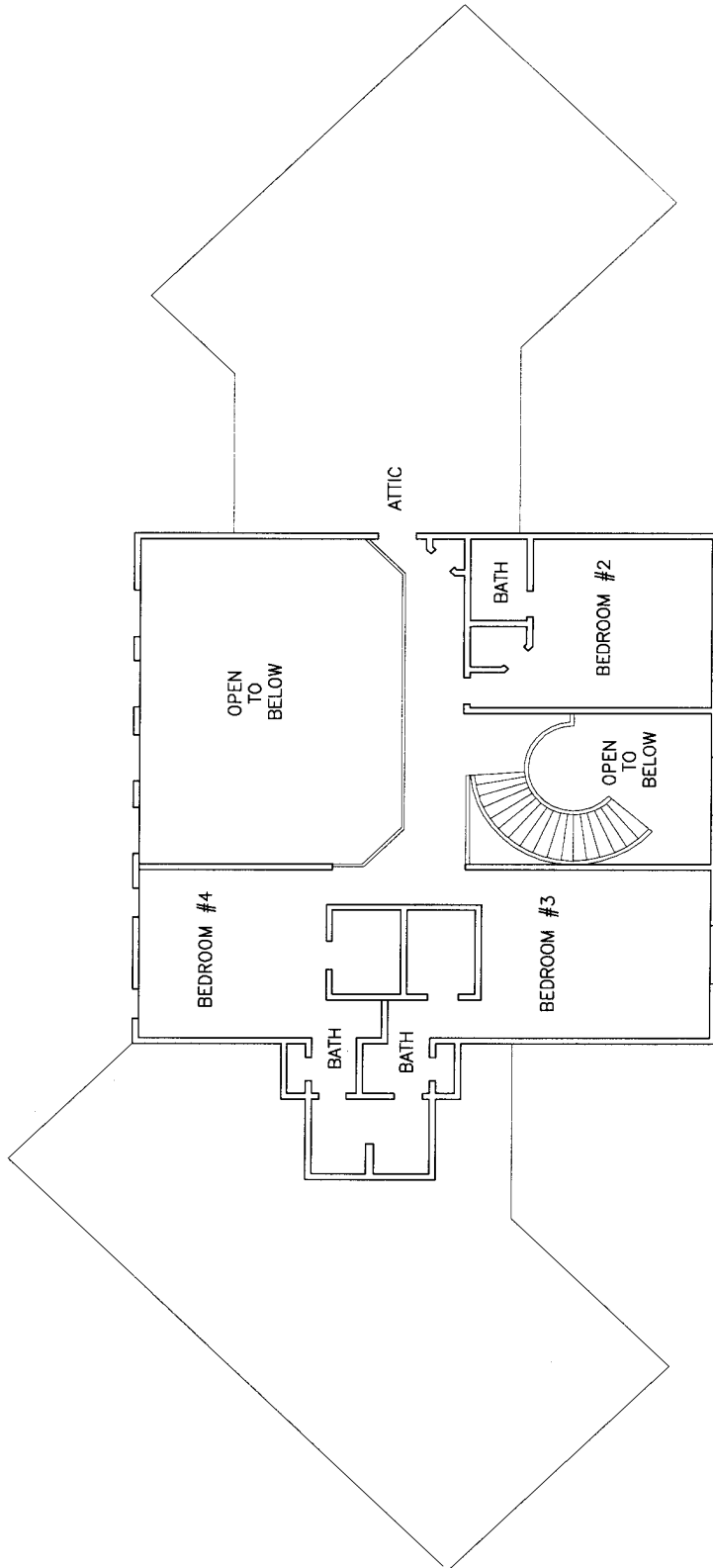

Figure 2 - First floor plan

**DEMONSTRATION HOME 1 - BACKGROUND**

---



**Figure 3 - Second floor plan**

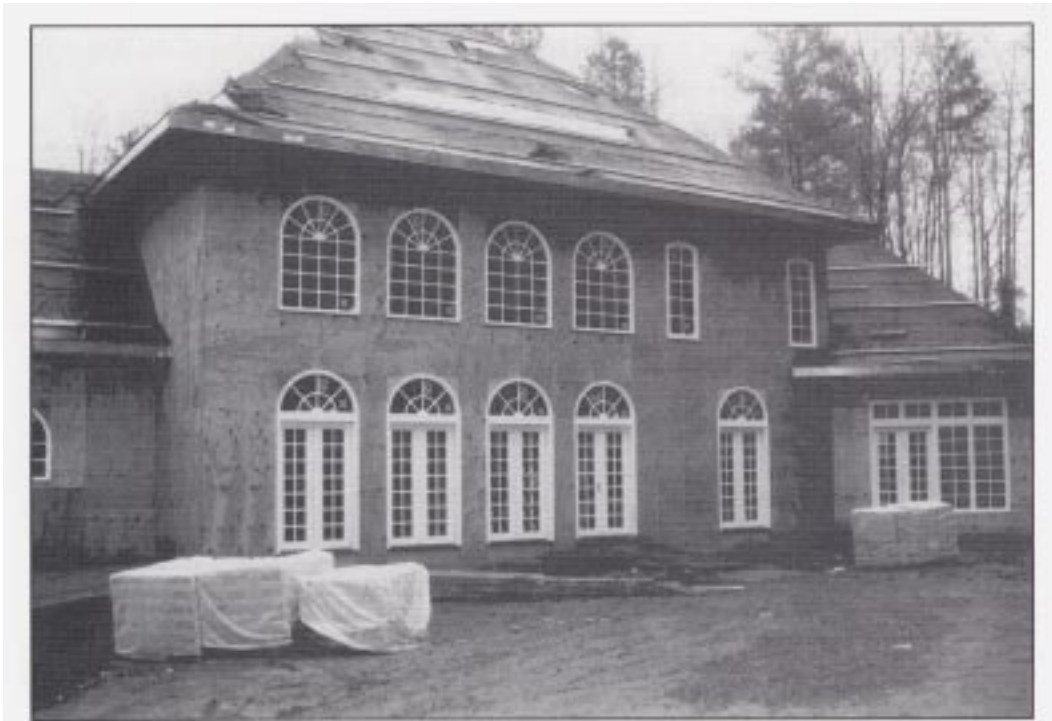

**Figure 4 - Exterior view of house**

## **OBSERVATIONS**

### **Planning/Materials**

The demonstration house was originally designed as a conventional wood-frame structure. The steel manufacturer provided the materials and the engineering support necessary to convert the construction plans to cold-formed steel framing using a “stick-for-stick” substitution. The “stick-for-stick” method replaces each wood member with an equivalent steel member. Member spacings and locations remained essentially unchanged.

Several materials used in the project were common to conventional construction, with the obvious exception of the steel framing. The conventional materials included plywood subflooring, exterior plywood wall sheathing, gypsum wall board, brick veneer, plywood roof sheathing, and asphalt roof shingles.

Residential steel framing was not common in the Raleigh area, and the building code officials had little experience in this area. Considerable work was expended in sharing information with the building officials to answer their concerns prior to and during construction. An extensive set of engineer-stamped drawings (including over forty framing details) were provided by the manufacturer for the plan review and construction process. The site inspections took longer than normal but presented no serious problems or delays.

### **Tools**

Several tool companies provided products to demonstrate available fastening systems. Products included screw guns, magazine attachments, and pneumatic nailers or pin drivers. Screws were installed using a variable speed screw gun with a clutch to prevent operator-induced fastening problems such as over-driving. The clutch provides torque to the screw until it is snug, then releases the screw from the driving action of the screw gun. However, some operator skill and care was required to avoid misuse resulting in weakened connections. Magazine attachments which allow a clip of screws to be used permitted faster screw installation on this project by eliminating the need to individually set screws on the screw tip. The magazine mechanism also provides additional support for the screw, virtually eliminating screws from sliding along the metal or rotating out of the driver bit while boring the hole. Extensions which permit floor decking to be installed while operating the tool from a standing position were also used. These tools helped to reduce the installation time for screws in certain applications.

Recent advances in fastener technology for steel framing include pneumatic pin drivers. These were used to fasten wood sheathing to steel members. These tools operate much like nail guns and provided rapid fastening. Two of these systems were used, both of which have been approved for use by model building codes.

At this demonstration project, cold-formed steel was cut with a saw or sheared. The following power tools were used at the site:

- a chop saw with an abrasive aluminum oxide blade was used to cut steel members including studs, joists, and track;
- a standard circular saw with an abrasive blade (also used to cut steel members); and,
- hand-held power shears used for miscellaneous cuts.



## DEMONSTRATION HOME 1 - OBSERVATIONS

---

Non-power tools included hand or aviation snips used to cut and trim, tong-shaped (c-clamp) vice grips for holding cold-formed members together during fastening, and magnetic levels which adhere to the steel.

### Floor Framing

The floor joists were 16 gauge<sup>2</sup>, full-size 2x10 C-shapes spaced at 16 inches (406 mm) on-center. Figure 5 shows the steel floor joists being installed. The tool used for steel-to-steel connections was a variable-speed screw gun. Fasteners consisted of #10 self-drilling hex-head screws and #8 self-drilling wafer-head screws. Figures 6 and 7 show the floor joists attached to a built-up steel beam of cold-rolled sections and a hot-rolled beam, respectively. Of particular interest are the clips used to attach the joists to the steel beams.

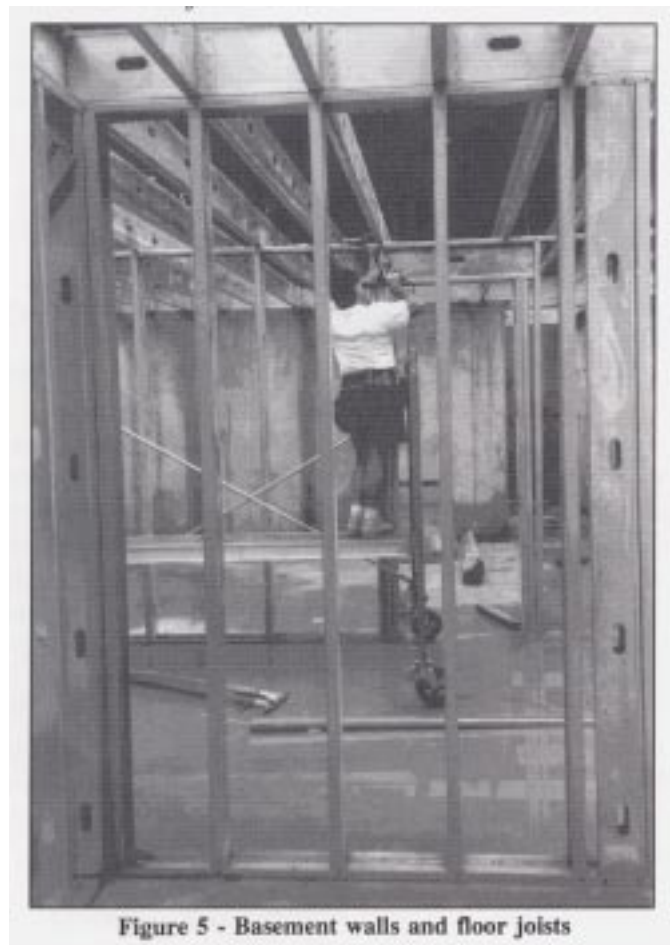

---

<sup>2</sup> Current efforts to develop a prescriptive method for steel framing use a mil thickness designation. A mil is the thickness in decimal thousands of an inch multiplied by 1,000. For example, 16 gauge is 0.0538 inches thick or 54 mil.

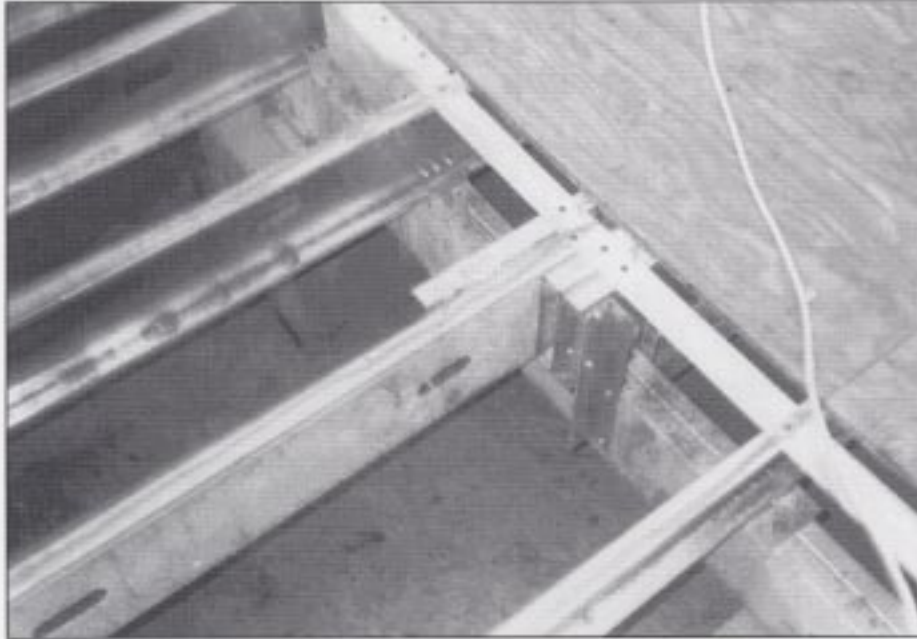

Figure 6 - Top view of beam connection



Figure 7 - Bottom view of beam connection

The floor sheathing was 3/4 inch (19 mm) tongue and groove plywood (Figure 8). Three different fastening tools were used to attach the plywood to the steel joists. The first tool was a screw gun fitted with an extension and a magazine to drive #8 bugle-head screws through the plywood and into the steel joists. This tool automatically advances a screw to the gun's extended driver and allows the user to quickly and easily fasten the plywood to the joist without bending over. The second and

## **DEMONSTRATION HOME 1 - OBSERVATIONS**

---

third tools were pneumatic pin drivers made by different companies. These tools operate much like a conventional nail gun by shooting steel friction-fit fastening pins into the plywood and steel joists. The joists contained factory punchouts for plumbing and electrical installation. The most notable observation related to the floor was the straightness and flatness of the assembly (Figure 9).

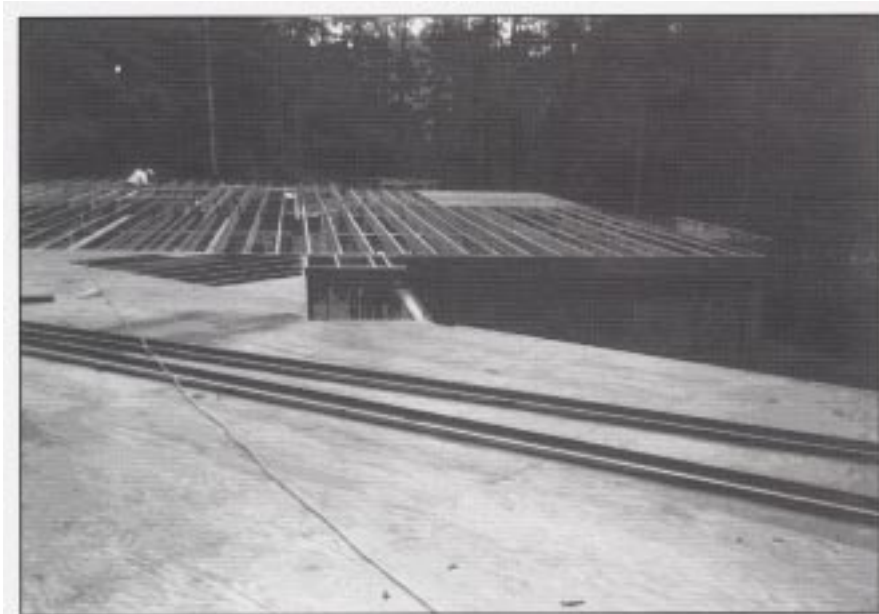

**Figure 8 - Floor sheathing on joists**

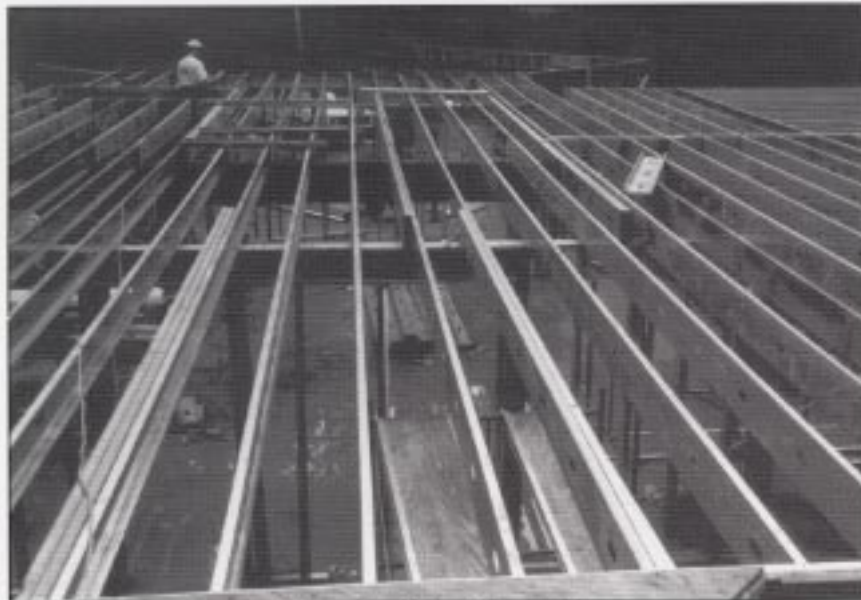

**Figure 9 - View of floor joists**

**Wall Framing**

Exterior foundation walls were primarily concrete, although the walk-out portion of the basement was framed with steel. The steel framed basement walls were similar in layout to a wood framed wall (Figure 10). However, it is important to note that the load-bearing studs were laid-out to maintain close alignment with floor joists above—a practice known as “in-line” framing. This practice was a necessary outfall of using light-gage steel framing in lieu of wood-framed walls which have a more substantial top plate.

Throughout the house, 2x6 wood studs were replaced with a nominal 2x6 steel C-section, and a U-channel track was used in place of wood top and bottom plates. The steel-framed basement walls were stick-built to accommodate many variations in the wall heights and footprint. First and second floor walls were framed on the ground and lifted into position at a later date.

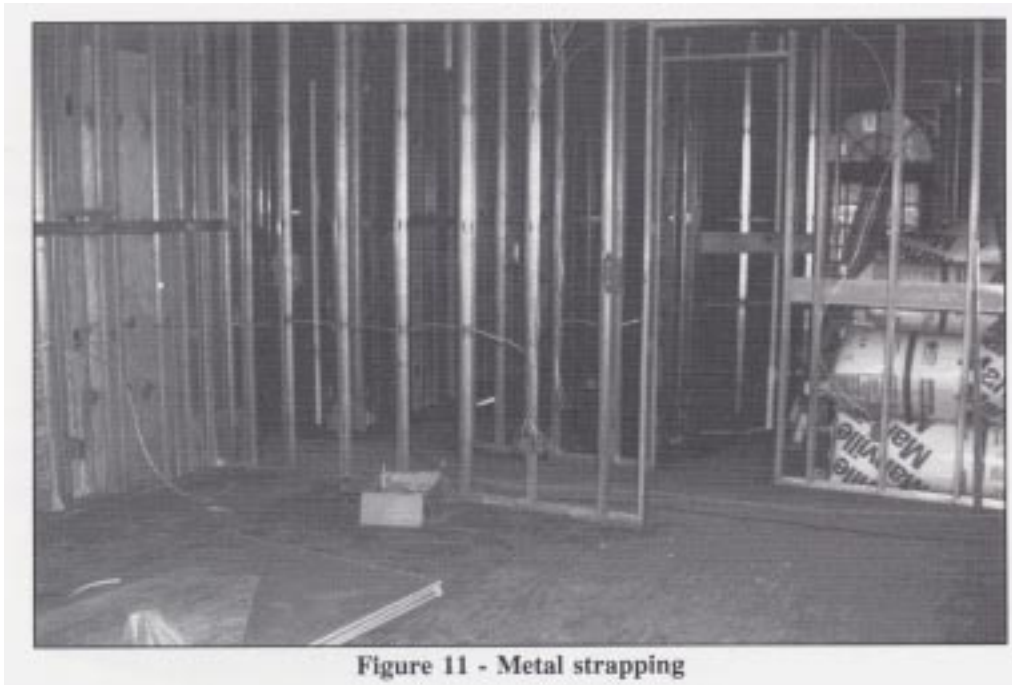

**Figure 10 - Installation of basement walls**

Wall studs were spaced at 16 inches (406 mm) on-center. Partition walls used 25 gauge steel and most bearing walls (interior and exterior) used 20 gauge steel. A number of 16 gauge steel studs were used for 20 foot walls in the great room. The home’s exterior walls were sheathed with 1/2 inch (19 mm) plywood. Horizontal bracing was provided at the mid-point of the walls with flat steel strapping, either 2 or 6 inches (51 or 152 mm) wide (Figure 11). Wall framing members were fastened together with #8 self-drilling wafer-head screws. The wafer-head screws have a low profile on the exposed head which minimizes interference with the gypsum wallboard. Screw guns were used for all wall framing connections.

## DEMONSTRATION HOME 1 - OBSERVATIONS

---



### Roof Framing

The home featured a high-pitched gable roof system which was quite complex (Figure 4). The hip rafters were 16 gauge 2x10 C-shapes with a nominal depth of 9-1/4 inches (235 mm). All ceiling joists were 18 gauge, full-size 2x6 C-shapes spaced at 16 inches (406 mm) on-center. In some instances the joists spanned over 15 feet (4.6 m).

### Utility Installation

The house included six full baths and one half-bathroom, along with two complete kitchens. The builder reported that the plumbers completed their rough-in without complication. Water supply pipes were CPVC and waste and vent pipes were PVC. The plumbers took advantage of the pre-punched holes in the studs when routing the pipe (Figure 12). Figure 12 also illustrates the grommets which secure the supply pipes. The collars in Figure 12 were used to protect the waste pipe from potential damage caused by the edge of the punchout.

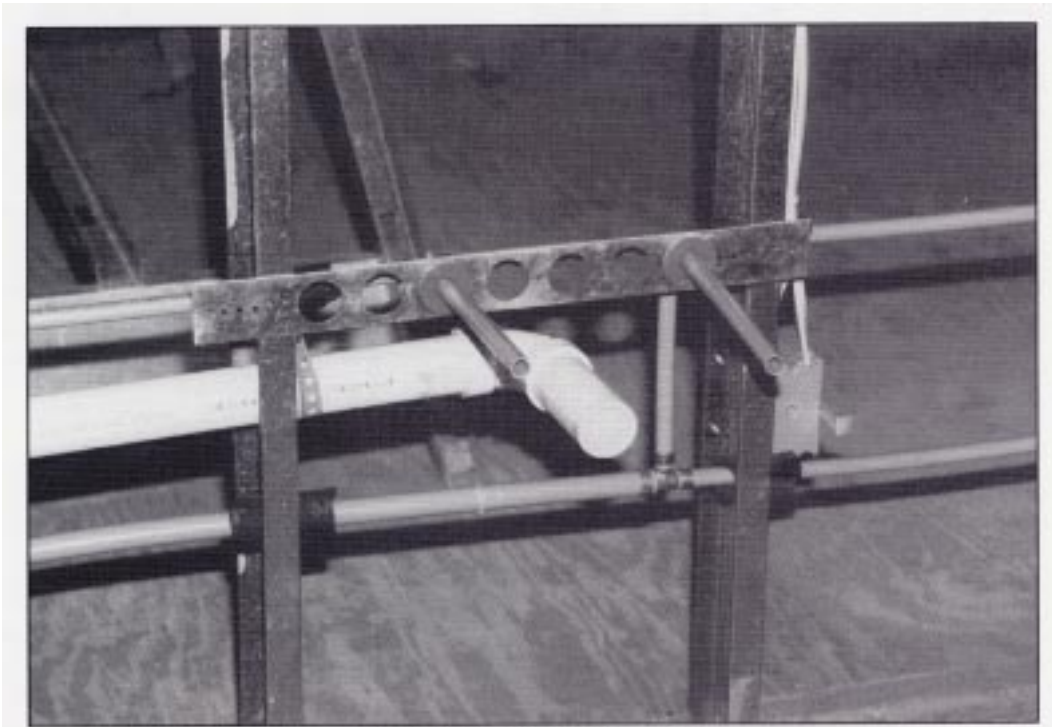
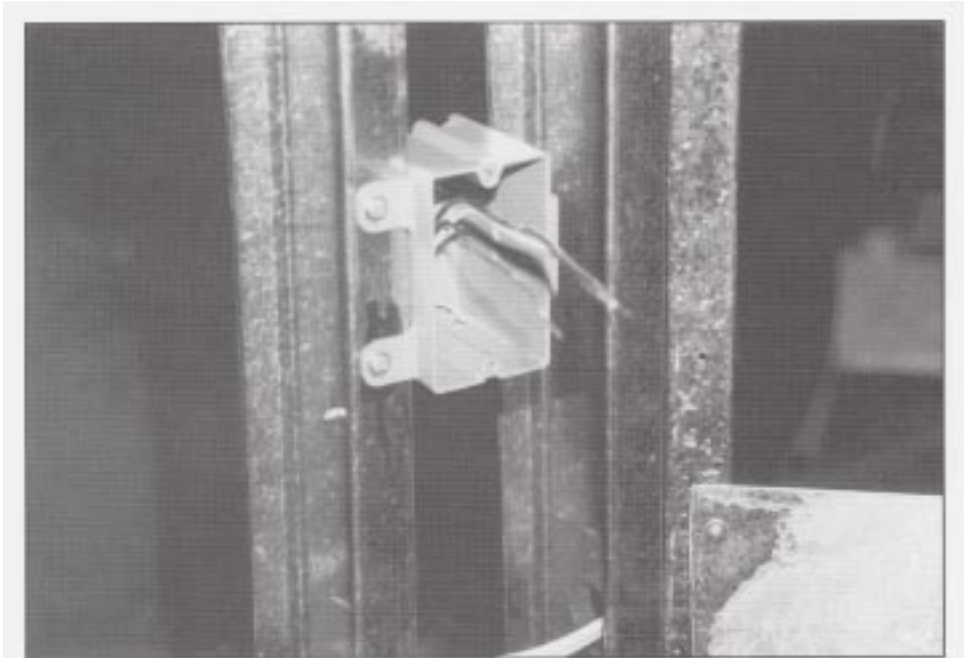

Figure 12 - Plumbing detail

The electricians reported that the overall job required about the same amount of effort and time as a wood-framed house. Mounting the electrical boxes took longer since they had to be screwed, instead of attached with pre-started nail boxes commonly used with wood framing (Figure 13). The electrician explained that time savings were achieved by routing wires in the pre-punched steel studs. Plastic grommets were used to protect the wire passing through the studs (Figure 14). The electrician also reported that it was the easiest wiring job he had completed even though this was his largest and most complex home project. The only exception was some minor difficulties on one wall where the punchouts did not align with each other. The ease of wire pulling was attributed to pre-punched holes and the use of low-friction grommets.

**DEMONSTRATION HOME 1 - OBSERVATIONS**

---



**Figure 13 - Electrical box**



**Figure 14 - Electrical wires**

**Architectural Details**

One advantage of steel was evident in the arched ceiling construction above the foyer (Figure 15). Other variations of custom ceiling details are in the master bedroom (Figure 16), the master bath (Figure 17), and the dining room (Figure 18). The dining room featured a vaulted ceiling, with an 8-foot (2.4 m) outside edge giving way to a 9-foot (2.7 m) oval and then a 10-foot (3.0 m) oval. In each case, the flexibility of light-gauge steel enabled a complicated non-structural framing detail to be constructed with relative ease.



Figure 15 - Open foyer

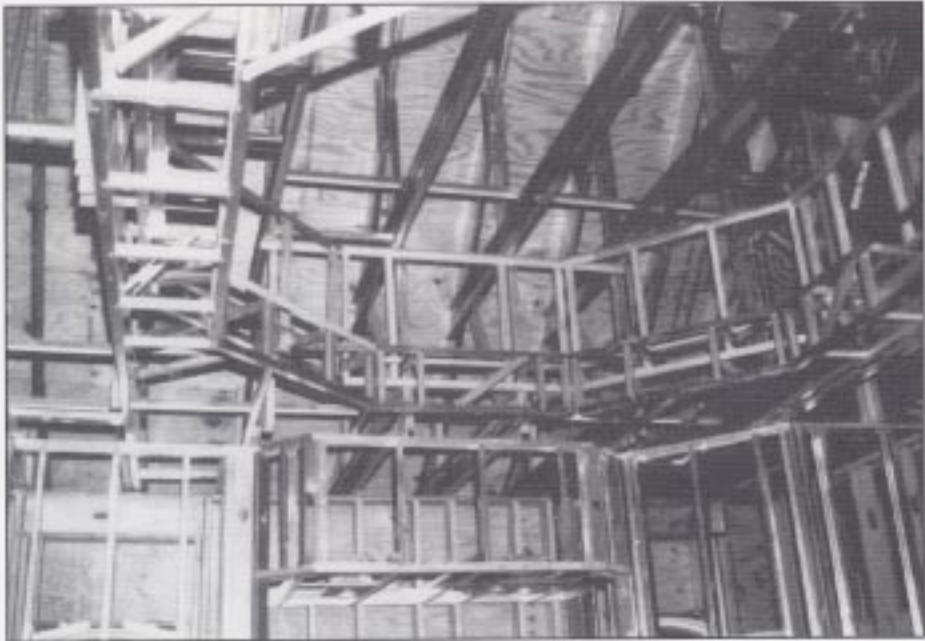

Figure 16 - Master bedroom



**DEMONSTRATION HOME 1 - OBSERVATIONS**

---



**Figure 17 - Master bathroom**



**Figure 18 - Dining room**

The three arches at the entrance to the great room (Figure 19) are a notable example of a detail which is relatively easy to do in steel. The flange of the track was cut approximately every inch, permitting the track to be curved to the desired shape. Figure 20 provides a close-up view of this technique.

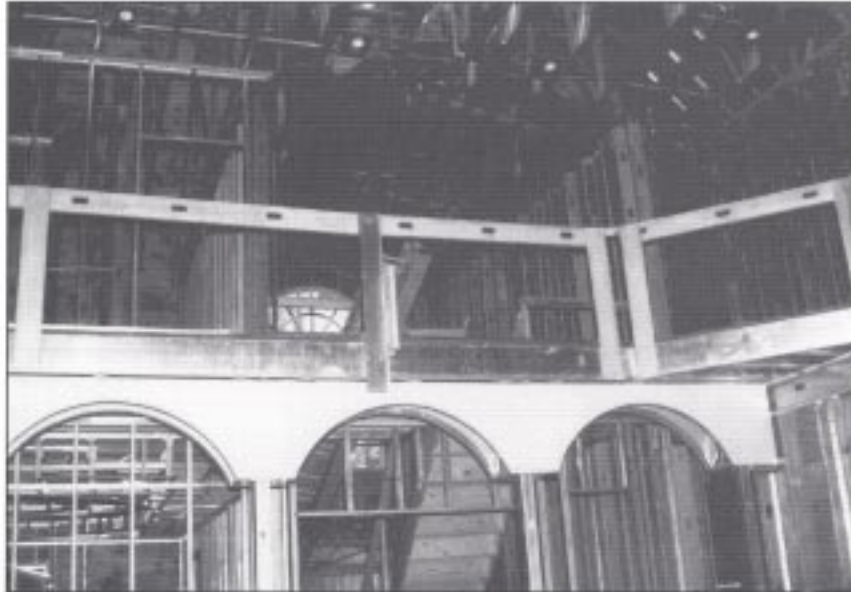

Figure 19 - Arches in great room

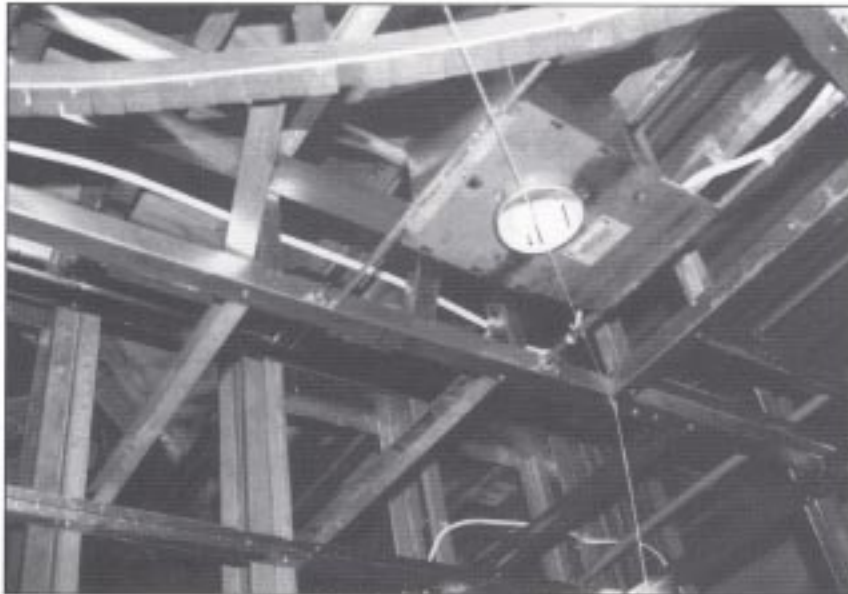

Figure 20 - Detail of curved framing

Some details took longer to complete than expected. An example is the portion of the second floor balcony bridging a corner of the great room (right side of Figure 20). This small triangular bridge required four hours for two framers to complete.

## DEMONSTRATION HOME 1 - OBSERVATIONS

---

The great room provided a notable example of an avoidable problem experienced at the demonstration project. The great room involved a two-story exterior wall with many windows (Figure 21). The original wood drawings called for continuous 2x6 studs, 16 inches on-center, with three 2x6's on each side of a window header. The original steel design replaced the wood 2x6's with 18 gauge 2x6's in a "stick-for-stick" substitution. However, revised shop drawings called for the walls to be made from 16 gauge steel 2x6's. There was some confusion whether the detail showed a continuous wall from top to bottom plate or two walls stacked on top of each other (platform framing). The framing crew decided on a conservative solution and framed the walls according to the original steel drawings using 16 gauge steel 2x6's (not 18 gauge), including three studs on each side of the window headers. They also added full-height 20 gauge 2x6's because 20 gauge or thinner steel does not require self-drilling screws for the application of wall finishes. This field modification required more material and labor than needed and created unnecessary delays. These conflicts may have been avoided with better planning or relevant prescriptive requirements which provide guidance in the field for a more efficient decision-making process.



Figure 21 - Great room



Figure 22 - Detail of great room

## Participant Perceptions

At the end of the first visit, on-site personnel were interviewed to document their perceptions of steel framing. Their observations are summarized as follows:

### Advantages:

- greater design flexibility,
- exact or consistent sizing of members,
- straighter walls and flatter floors, and
- lighter than wood.

### Disadvantages:

- lack of experienced framing labor,
- lack of experienced subcontractors (plumbing, electrical, etc.),
- lack of standard products, and
- lack of code-approved prescriptive guidelines (span tables, fastener schedules, etc.).

The experienced steel framers felt that they could perform their job more efficiently than they could with wood. They stated that they could frame a steel house, with the exception of the trusses, at least as fast as a wood-framed home. The experienced wood framers felt that working with steel was initially awkward. They said that they wanted to “hang in there and give steel framing a chance” because of the quality they perceived in the end product.

A follow-up discussion was held with the builder’s wood-framing supervisor to get his opinion on steel framing after the job was nearly complete. He was enthusiastic about the quality of the finished product in appearance and did not have any significant problems with the fastening and cutting methods used on the project. However, he felt working with steel took longer. He was extremely interested in efforts to standardize the steel framing industry, as he felt this would simplify the use of steel framing. He and another participant on the demonstration project were planning to start their own steel homebuilding company.

A meeting with all personnel at the jobsite resulted in an open discussion concerning the construction experience and the potential benefits of prescriptive construction guidelines and standardized materials. The group supported the need for prescriptive standards for steel framing and cited the following reasons:

- The availability of uniform and interchangeable products (standard sizes and shapes) would limit unexpected complications related to supply, design, and construction. Frequently, these complications result in avoidable project delays.
- Prescriptive methods would provide basic guidance to framers and code officials and allow common issues to be resolved in the field without special engineering.

## **DEMONSTRATION HOME 1 - OBSERVATIONS**

---

- The standardization of a “conventional steel framing” method should result in increased availability and decreased costs of basic steel framing members.

The framers working on the project expressed their concern that frustrating conflicts occur in the field when the design has a flaw or missing details. When this happens, progress virtually stops until the framers can get together with the engineer and resolve the issue. As expected, the demonstration house had many of these problems due to the complexity of the house. One experienced steel framer stated that at times they had to make structural decisions in the field which he called “field engineering.” Without code guidance or standards these decisions can result in lost time and improper design, depending on the experience of the framer. These problems are not uncommon to any construction project but are particularly difficult to resolve with cold-formed steel since it is an unfamiliar material in the home building industry.

## **PART II: DEMONSTRATION HOME 2**

### **BACKGROUND**

Demonstration Home 2 consisted of the basic framework for a 720 square-foot (66.9 m<sup>2</sup>) one-story house with an attached garage. The floor plan is shown in Figure 23. Its primary purpose was to demonstrate a variety of practical steel-framing details. For example, several methods of bracing walls were demonstrated including strap-braces (x-brace), sheet steel, and plywood. In addition, a variety of tools and fastening methods were examined. Additional demonstration topics, such as low-cost fastening methods for insulation panels, will be pursued at this site in the future.

With the exception of the lead framer, the crew lacked any previous framing experience with cold-formed steel. A few participants were experienced in wood-framing of homes and other structures. The participants who had wood-framing experience adapted to the steel framing process more readily than those with less construction experience. The lead framer had nearly 20 years of cold-formed steel experience, including the construction of approximately fifty homes and small commercial structures. The entire framing process lasted about 5 days.

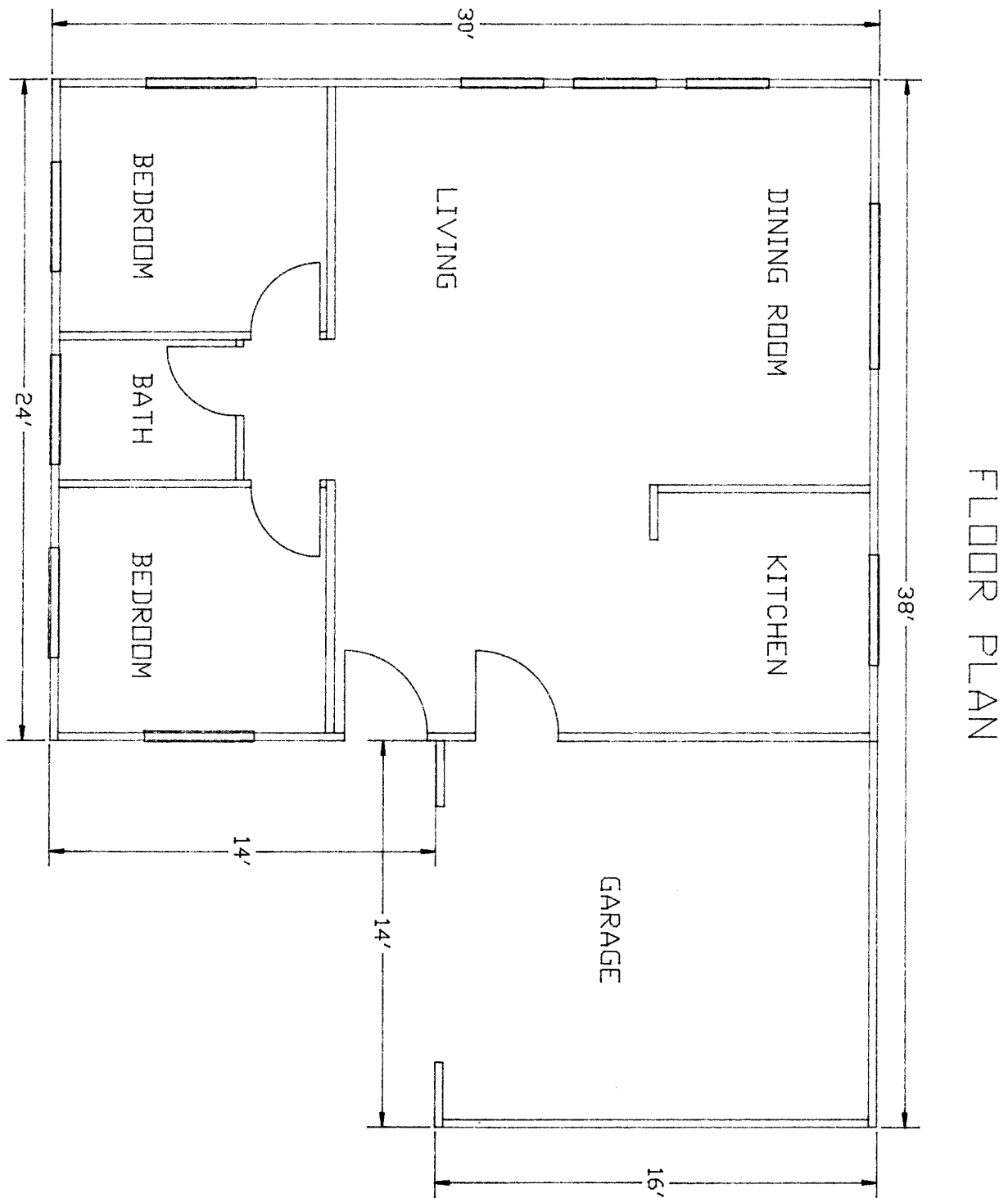

Figure 23 - Floor plan

## OBSERVATIONS

### Planning/Materials

A “cut-list” was essential to the efficient construction of the demonstration home framework. A cut-list is a detailed material order which directs the steel supplier to provide “pre-cut” materials that match the dimensions of a specific project. Pre-cut pieces were bundled and labeled by the manufacturer based on their specified end-use to conserve time and labor during construction. For instance, all of the materials needed for the first floor load bearing walls were pre-cut, bundled and labeled “1st floor load bearing walls.” A copy of the cut-list can be found in the Appendix.

When the material was received at the Research Center, the shipment was checked against the cut-list prior to unloading. A small forklift unloaded the bundles of material, which in some cases were not packaged to prevent damage during unloading. Additional laborers were required to stabilize the load and prevent material buckling in these instances. A forklift with wider forks would have been useful on the longer bundles, some of which were 30 feet (9.1 m) long.

### Tools

The lead framer preferred to use a 0 - 4000 rpm variable speed screw gun because he could use it to install drywall, plywood and screws for all the framing connections. He mentioned that some framers may find a 2500 rpm gun easier to use at first. The comfort of the screw gun and ease of reverse switching were found to be important considerations. In particular, the grip of the screw gun should allow the body of the gun to fit comfortably into the palm so that the center of the fastener is a direct extension of the operator’s arm. This grip technique minimizes fatigue and gives greater control of the tool.

Other tools unique to steel framing included:

- Clamps - Small quick-release clamps were used extensively when fastening steel members together. They held the members together during fastening and prevented stripping of the steel. Wide-throat clamps were used in hard to reach places or when standard clamps could not grip due to the size or positioning of the members.
- Aviation Snips - These snips were used for trimming, notching, and cutting thinner steel members (typically 20 gauge or thinner). For instance, they were used for cutting and trimming of tracks for connection details in door and window openings.
- Handbrake or Seamer - This tool was used to quickly bend pieces of the steel members for a variety of purposes. For instance, the handbrake was used to prepare the ends of framing members for simple connection details.



## DEMONSTRATION HOME 2 - OBSERVATIONS

---

- Chop Saw - A chop saw with an abrasive metal blade was used since it provides a fast and precise method for cutting steel members of a wide range of thicknesses.
- Power Shears - Hand-held power shears were also used to quickly cut steel. These shears provided a relatively smooth edge and minimized damage to galvanizing. It was not as precise as a chopsaw, but it provided necessary support for a variety of framing activities including the trimming of large pieces of sheet steel and individual studs.
- Felt Tip Marker - Since a pencil mark does not show up clearly on steel members, a felt tip marker was a necessity for marking cuts and laying out walls. Two different colors proved useful to assist in the layout of walls, one color for stud locations and another for opening locations.
- Cordless Screw Gun - This battery-powered tool was not a necessity but was handy for small, isolated fastening needs. However, the speed was much slower than a screw gun.
- Electric Screw Gun - This power tool was used for nearly all connections. However, the screw gun was not able to access some “tight spots” to install screws. A number of long power cords were necessary to give the framers access to all construction activities with this tool.

Several attachments to the screw gun were used including:

Phillips Head Driver - This attachment was used with the screw gun to drive the #8 wafer-head screws. A magnetic tip was useful for holding the screws, but tended to collect metal shavings which clogged the tip from seating fully into the screw.

Hex Head Driver - This tool was used to drive the #10 hex-head screws. A magnetic tip was also useful for holding the screws.

Magazine Screw Feed - This attachment for the screw gun eliminated manual placement of individual screws into the driver attachment. This tool had a driver extension which eliminated bending over and accelerated the fastening of floor or roof decking. The extension was not a necessity at the site but proved useful. With the exception of the fastening of floor and roof decking, the magazine was too bulky for most framing connections.

## Fasteners

Two fastener types were used for all connections between steel members. The first, a #8 wafer-head screw, provided a low-profile head for fastening of framing members that were later covered with sheathing such as plywood or gypsum wallboard (Figure 24). A pan-head screw can also be used in this situation, although the screw head will protrude slightly higher above the surface than the wafer-head screw. The second fastener was a larger diameter #10 hex-head screw, which was used for structural connections such as trusses and headers (Figure 25). Both of these screws were self-tapping with built-in drill tips. The portion of the shaft above the drill tip had no threads. This allowed all of the members to be drilled completely before any tapping or threading starts, preventing separation of the members and stripping or over-drilling.

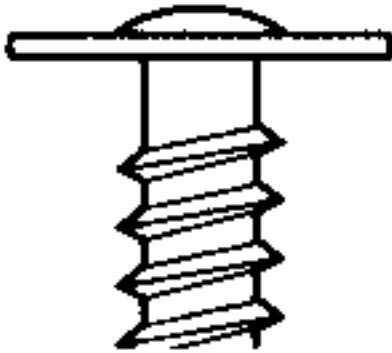

Figure 24 - #8 Wafer-head screw

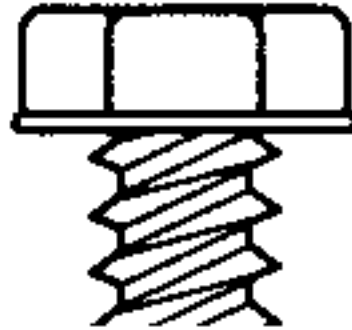
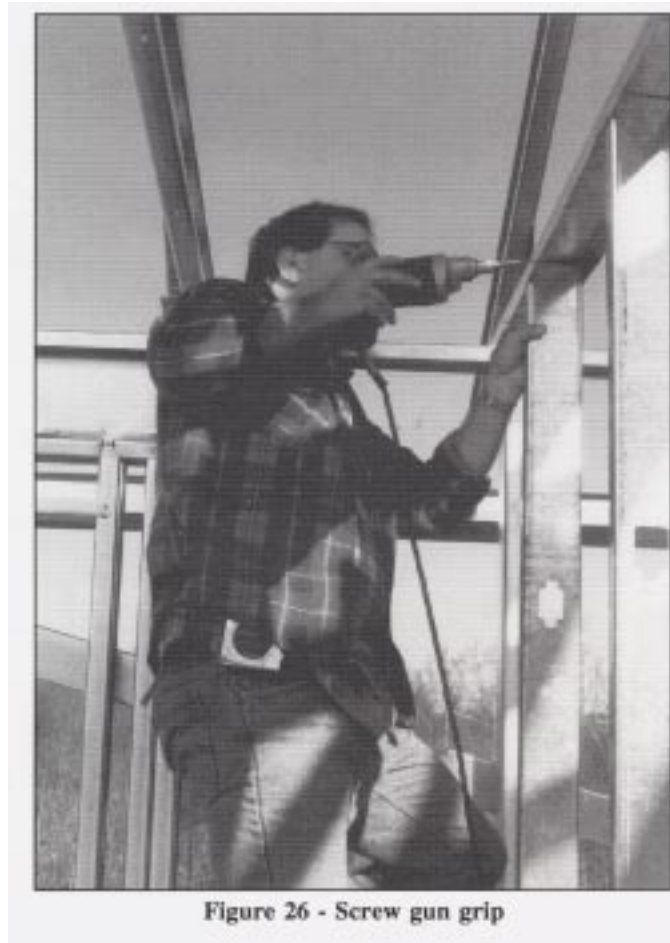

Figure 25 - #10 Hex-head screw

It became evident early in the project that an efficient screw driving technique is a very important skill in steel framing. When screws are driven with the correct technique they go in easily and effortlessly. With the wrong technique the worker will get fatigued and frustrated quickly. The proper grip positions the end of the screw gun in the palm so that the forearm is in line with the screw, providing maximum operator control for starting and finishing screws (Figure 26). The thumb and first two fingers should extend down the sides of the screw gun while the third finger (ring finger) controls the variable speed trigger. It is very important to get a “feel” for the gun and to develop a procedure so the screw is quickly installed and not overdriven. The operator should sense when the drilling process is done and then tap the trigger on and off during the threading process while only applying slight pressure when the trigger is on. This causes the screw gun to release the screw head when the screw is tightened to prevent over-torquing and stripping of the hole or threads. A screw gun with a properly set clutch will also prevent this problem.

## DEMONSTRATION HOME 2 - OBSERVATIONS

---



### Floor Framing

The floor joists were 18 gauge 2x8 C-shaped steel members. A web stiffener is often required to prevent crushing of the joist webs at the bearing points. A web stiffener is usually a short piece of steel (e.g. stud cut-off) attached to the web of a joist for additional reinforcement to prevent crushing or buckling of the web. Web stiffeners can also be ordered pre-cut if large quantities are needed.

An interesting detail was used to handle the connection of the floor joist to the wall without the need for a web stiffener. Instead of bearing the joist on top of the foundation, the ends of the joists were seated into a joist track (similar to band joist or ledger in this case) attached to the sides of the foundation wall, eliminating the bearing condition which would require a web stiffener (Figure 27). However, the load capacity of this type of connection may limit its usefulness.

The joists were attached to the track with # 8 wafer-head screws at the top and bottom flange. At interior bearings, a 20 gauge angle served as both a web stiffener and a connection between the foundation wall and the joists (Figure 28).



Figure 27 - Floor joist connection

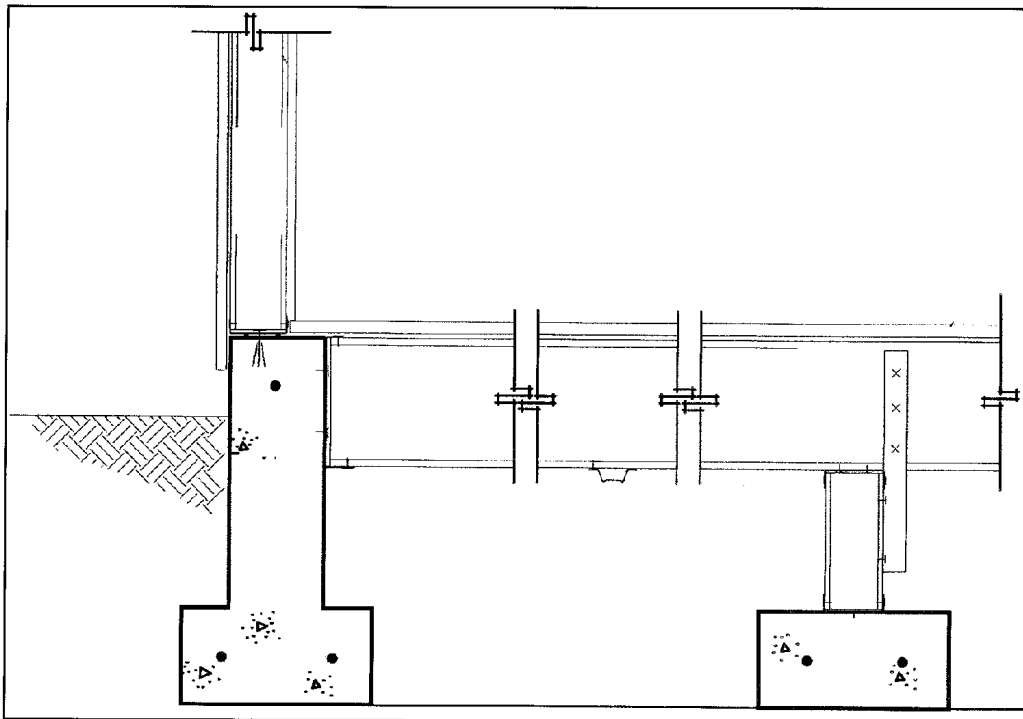
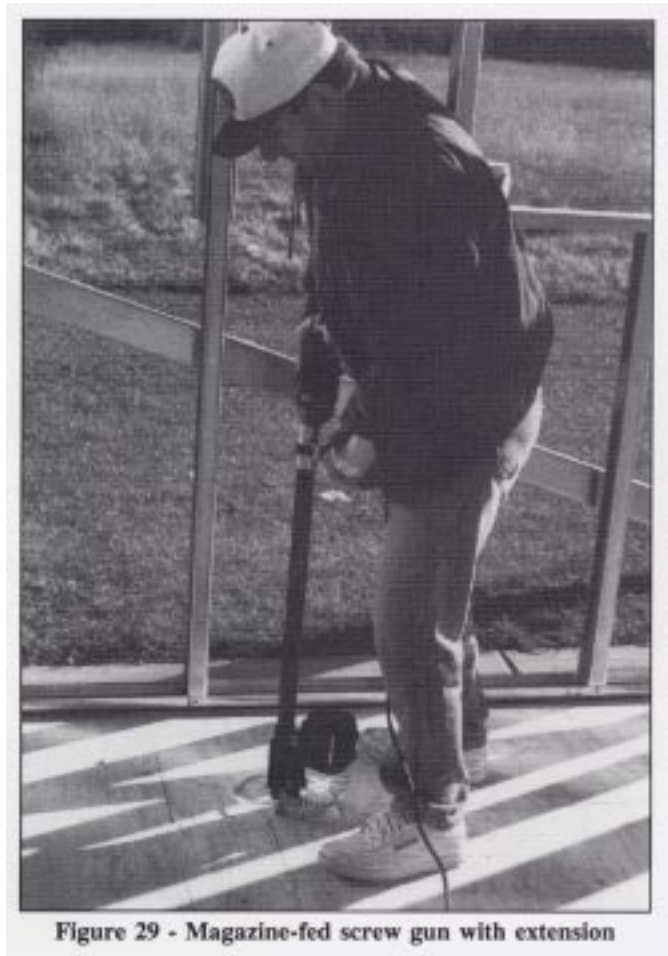

Figure 28 - Floor joist, interior bearing detail

## **DEMONSTRATION HOME 2 - OBSERVATIONS**

---

The sub-flooring was 3/4 inch (19 mm) tongue and groove plywood. A magazine-fed screw gun system was used to fasten the plywood sub-flooring to the steel joists using #6 bugle-head screws (Figure 29). These screws had pointed tips which were just able to penetrate the 18 gauge steel joists by applying some additional pressure to the drill. Although a common practice, no construction adhesive was applied.



**Figure 29 - Magazine-fed screw gun with extension**

**Exterior Walls**

The exterior wall studs were 20 gauge steel 2x4 C-shapes, measuring 3-1/2 inches (89 mm) wide. The top and bottom plates were made from U-channel or track with a slightly greater width to allow the studs to fit into the U-shaped track. The studs and track were fastened together with four #8 wafer-head screws, one through each track and flange overlap as seen in Figure 30. It was very important to nest the studs fully into the track to ensure solid bearing. This was accomplished by clamping the flange to the track and then lightly hammering the track to draw the two members together before fastening. Care was taken to ensure that the pre-punched holes in the studs lined up with each other for simplified mechanical and electrical rough-ins (Figure 31).



**Figure 30 - Stud and track connection**

**DEMONSTRATION HOME 2 - OBSERVATIONS**

---



**Figure 31 - Wall with aligned holes**

## DEMONSTRATION HOME 2 - OBSERVATIONS

Two different types of headers were used in the load-bearing walls. The first type, known as an I-beam header, was made from two 16 gauge 2x8 C-shapes joined back-to-back (Figure 32). The second type of header is a box-beam with two C-shapes connected open-side to open-side (Figure 33). The box-beam headers were insulated on the inside during fabrication. Structural headers were not used in walls located under the gable ends of roof trusses. Figures 34 and 35 show some of the common details for non-load bearing window and door openings.

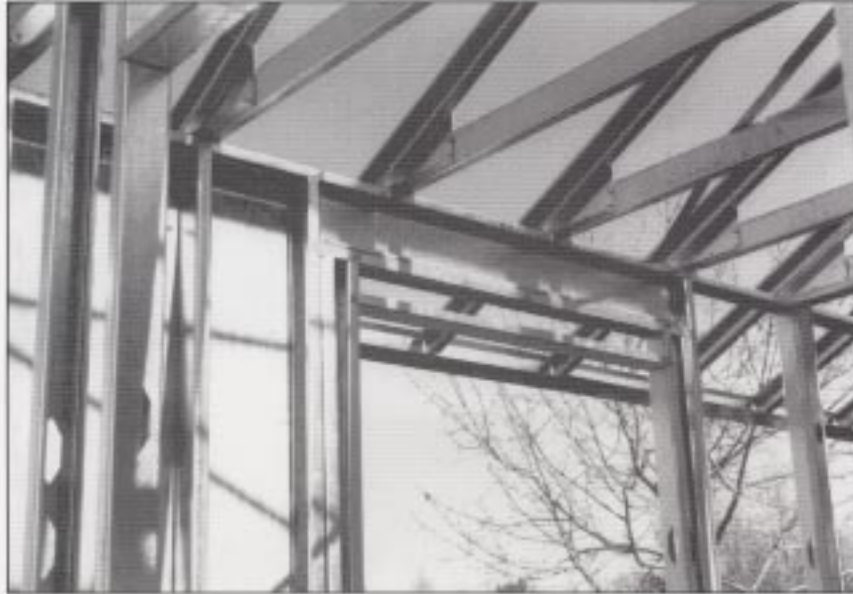
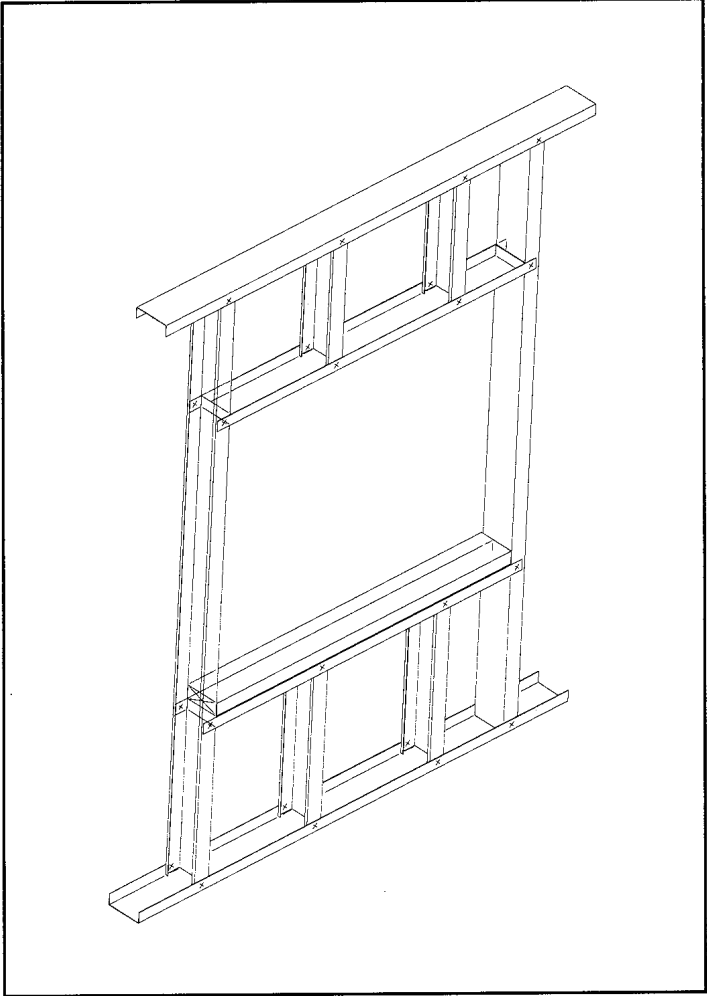

Figure 32 - I-beam header

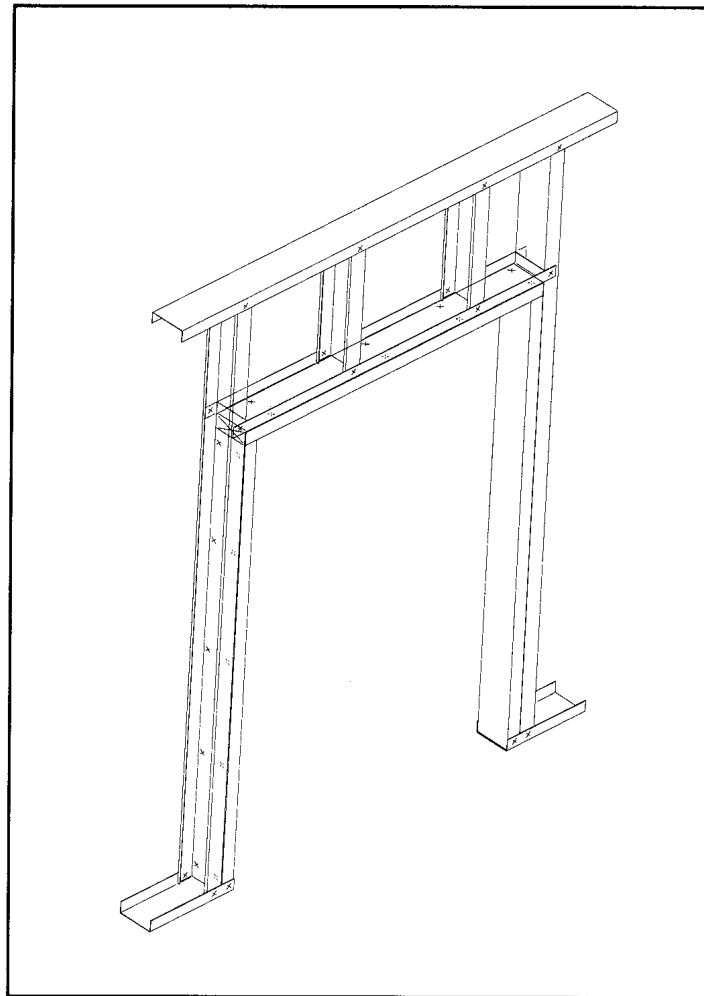

Figure 33 - Box-beam header





**Figure 34 - Window opening**



**Figure 35 - Door opening**

All of the exterior walls were panelized and hand carried to final position. The walls were screwed together at the corners (Figure 36). The bottom tracks were screwed to the temporary foundation. C-shapes were used as temporary diagonal bracing to prevent racking of the walls until permanent wall bracing was installed.

Three common types of permanent wall bracing were demonstrated on this project. The first type used plywood panels fastened to the steel studs with #8 wafer-head screws (Figure 37). The second type was steel x-bracing. This system used two six-inch (152 mm) wide, 20 gauge steel straps placed at diagonals (Figure 38). The straps were fastened at one end then tensioned using a modified clamp before final fastening. The straps were fastened with # 8 wafer-head screws, two at each stud and several at the ends. The third wall bracing detail used a 4 foot by 8 foot (1.2 m by 2.4 m) piece of 20 gauge galvanized sheet steel (Figure 39). This system was similar to the plywood bracing system except #8 wafer-head screws were used.

**DEMONSTRATION HOME 2 - OBSERVATIONS**

---



**Figure 36 - Panelized wall attachment**



**Figure 37 - Plywood wall bracing**

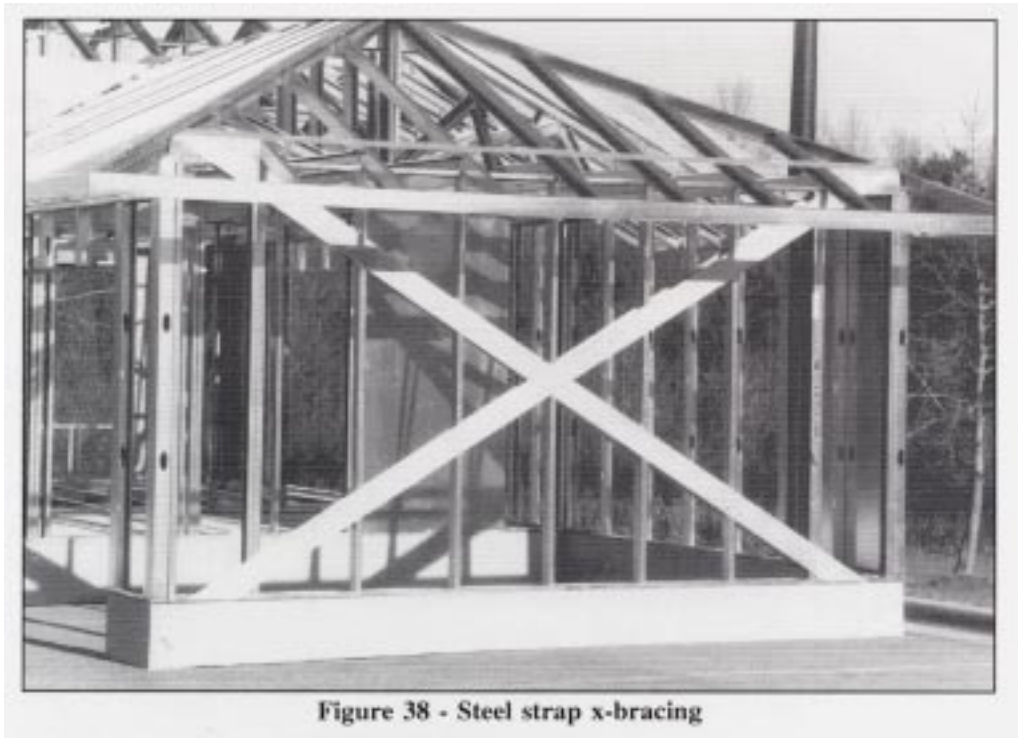

**DEMONSTRATION HOME 2 - OBSERVATIONS**

---

**Roof Trusses**

Roof trusses were panelized on site using pre-cut 20 gauge 2x4 C-shapes. Two different truss types were used, a scissors truss (Figure 40) for a cathedral ceiling detail and a Howe truss (Figure 41) for the flat ceilings. A single truss of each type was initially constructed from the drawings and a jig was then made to speed-up the construction of the remaining trusses (Figure 42).

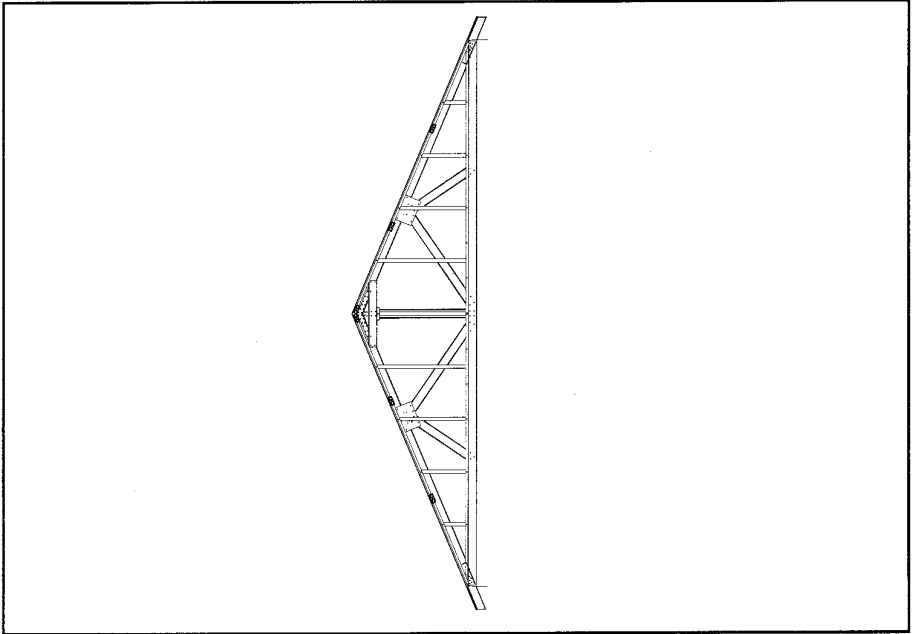
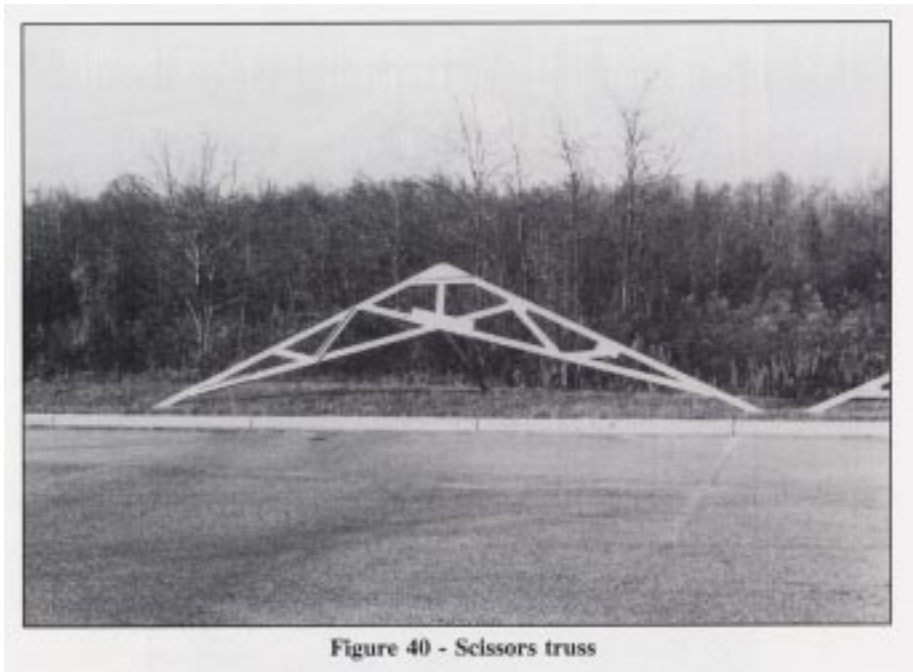

**Figure 41 - Howe truss**

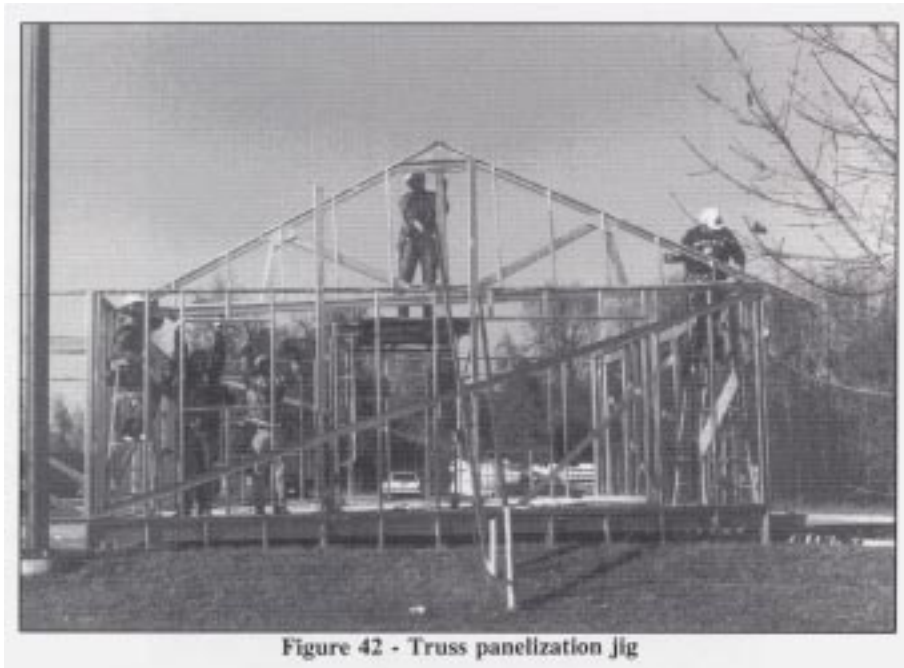

The trusses were erected similar to wood trusses. Care was taken to position, plumb and brace the first gable-end truss (Figure 43). The interior trusses were then set and positioned 24 inches (610 mm) on-center and braced. This process continued to the front gable end of the main roof (Figure 44). A similar process was followed for the garage roof. The garage roof had a hip that was framed using 2x4 C-shapes individually cut for the rafters (Figure 45).

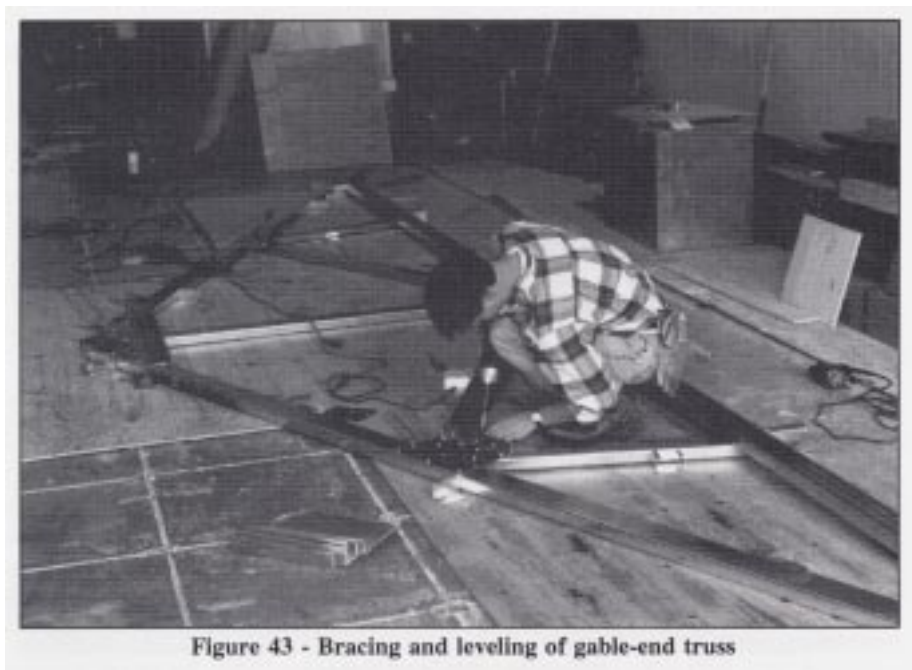

**DEMONSTRATION HOME 2 - OBSERVATIONS**

---



**Figure 44 - Setting interior truss**

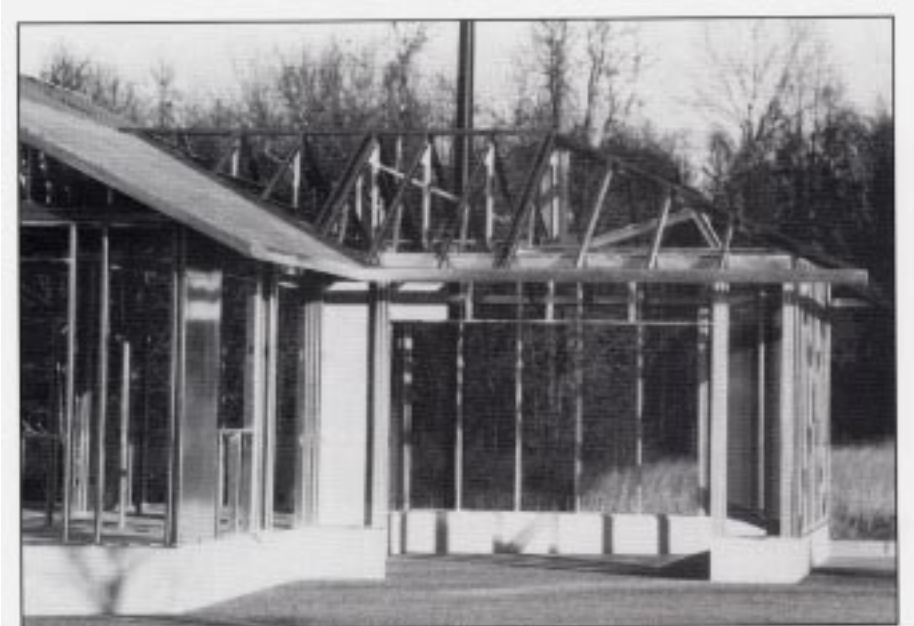

**Figure 45 - Hip roof rafters**

**Interior Walls**

The interior non-load bearing wall studs were 25 gauge 2x4 C-shapes with 25 gauge top and bottom tracks. First, the top and bottom tracks were laid out for stud locations and openings such as doors. Next, the top track was fastened to the trusses using #8 wafer-head screws. Using a plumb line or a level, the bottom track was positioned and then fastened. Finally, the studs were individually placed in the tracks and connected with #8 wafer-head screws.

**Utility Installation**

Plumbing and electrical wiring required some special attention to tools and fittings. Both plastic and copper pipes required grommets to prevent physical damage and to prevent galvanic corrosion between the steel framing and the copper pipe (Figure 46). The grommets have fins to grip and secure the pipe, restricting movement. The grommets fit into pre-punched holes in the steel members as shown in Figures 47 and 48.



Figure 46 - Plumbing grommet



## DEMONSTRATION HOME 2 - OBSERVATIONS

---

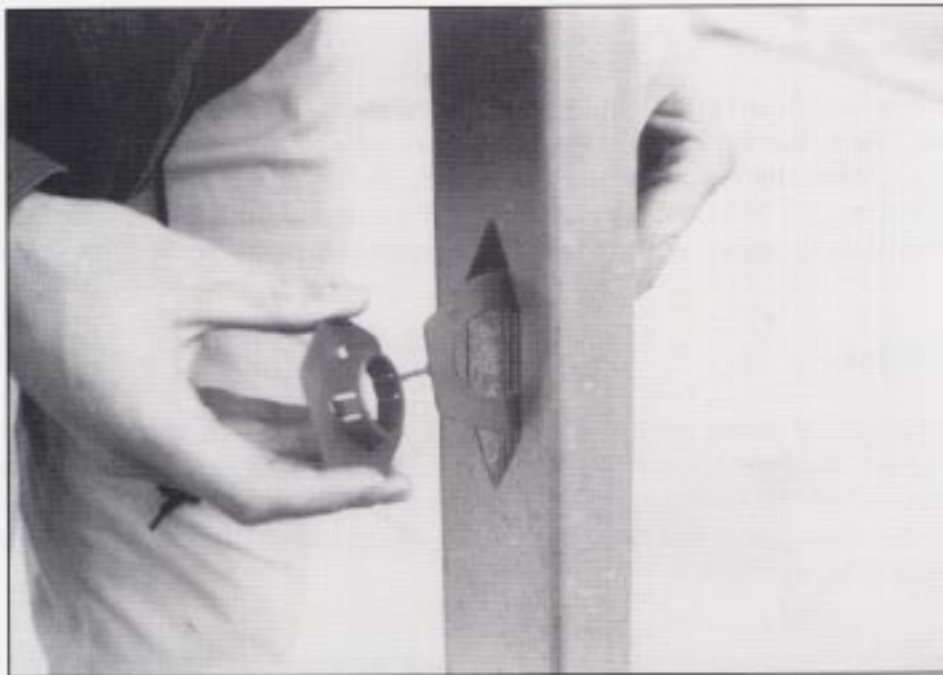

Figure 47 - Placing universal grommet

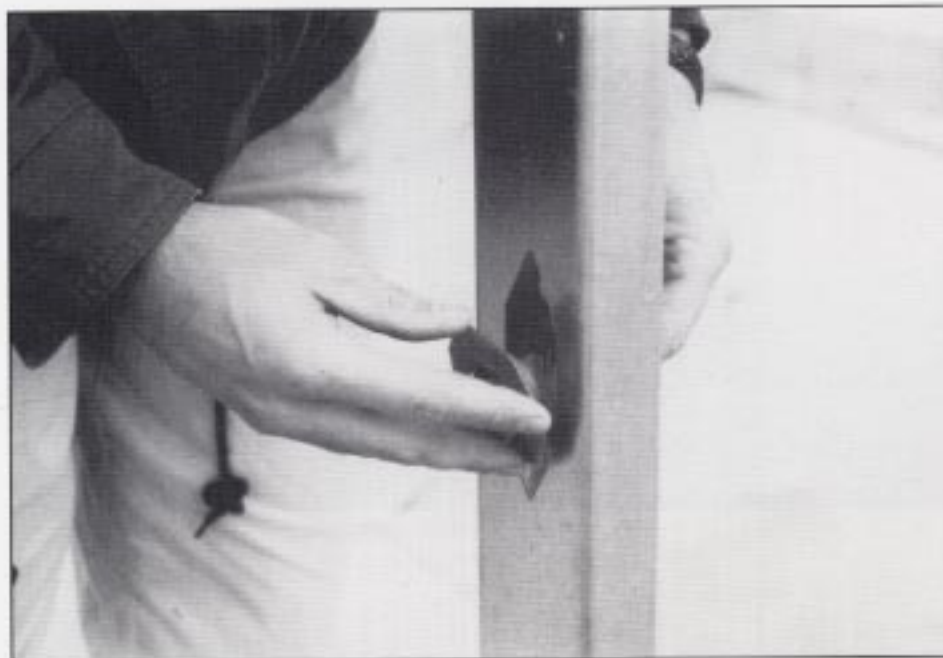
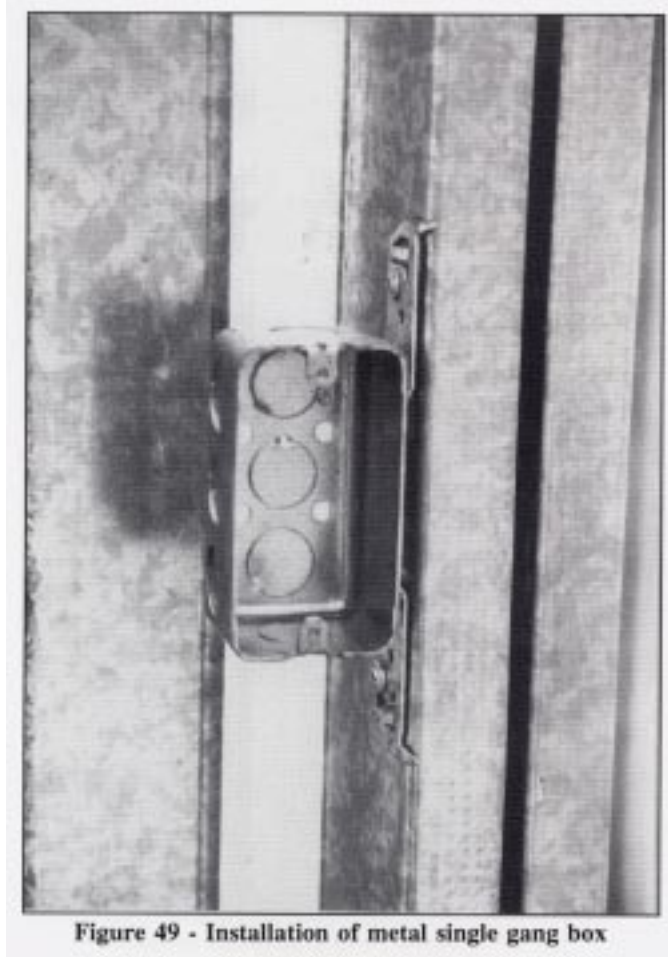

Figure 48 - Securing universal grommet

Plastic and metal electrical boxes were fastened to the steel framing using screws. The single gang box had hooks on the mounting tabs, which position the box to extend through the gypsum wallboard (Figure 49).



Several methods were used to strap and secure electrical wire. In one method, a small hole was field punched next to an existing punchout and a wire tie was run through the holes to secure the cables (Figures 50 and 51). A second method consisted of a wire tie with a self-adhesive plate (Figure 52). In yet another case a cable clamp was screwed to the studs and used to secure the cables.

**DEMONSTRATION HOME 2 - OBSERVATIONS**

---

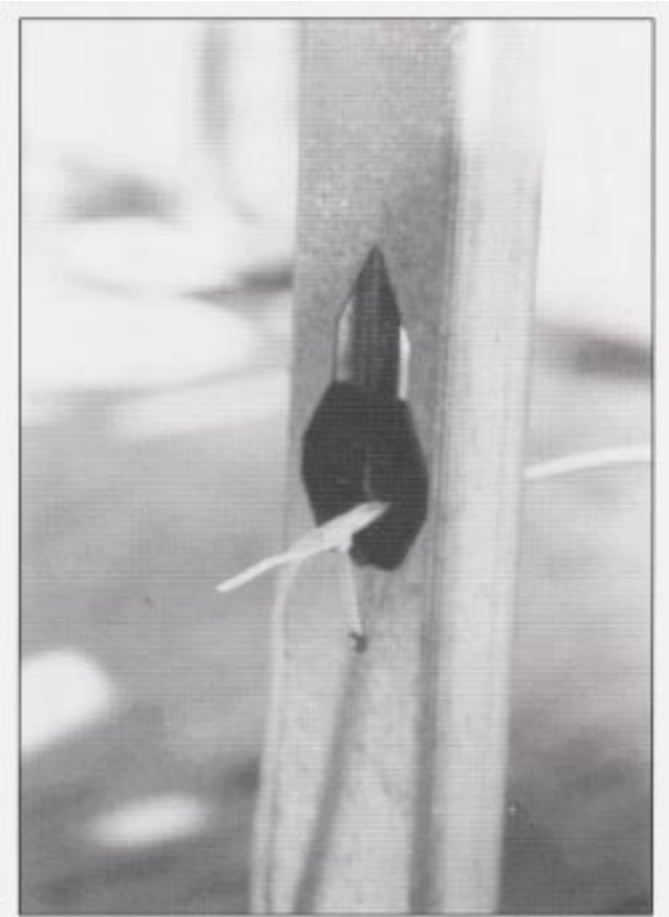

Figure 50 - Cable secured through punchout

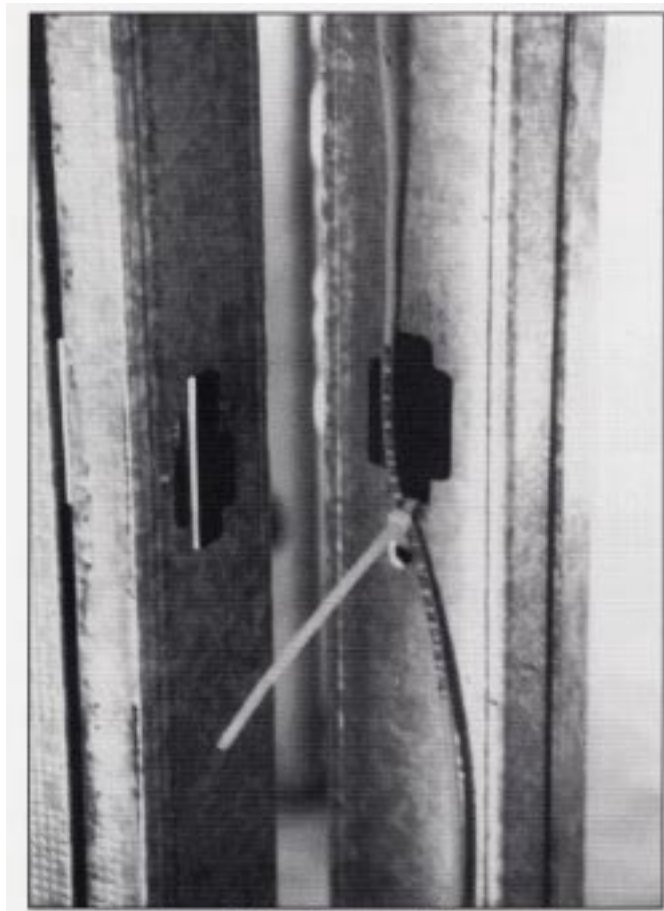
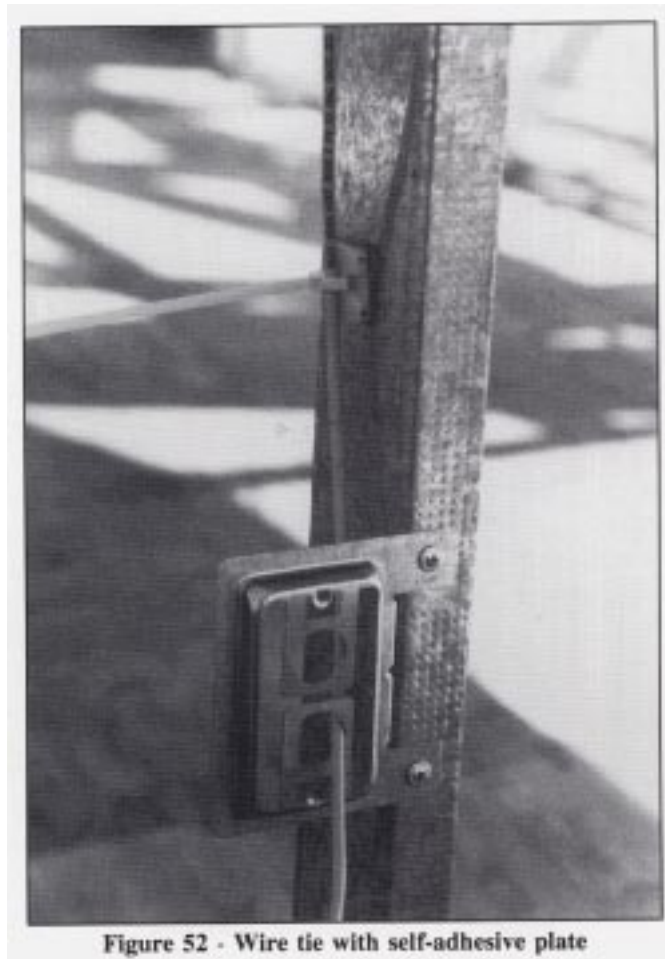

Figure 51 - Cable secured along stud



### **Field-Punched Holes**

Although many steel members have pre-punched holes, there were occasions when an additional hole was needed. For example, tracks (used as top plates) are not pre-punched, but holes are frequently needed for wiring and vent stacks. Holes were drilled with a hole saw, or punched with a punchout tool (Figure 53). The punchout tool and grommets were available at local electrical supply distributors.

**DEMONSTRATION HOME 2 - OBSERVATIONS**



**Figure 53 - Punchout tool**

## CONCLUSIONS

Both demonstration projects provided useful observations on the use steel framing in a large custom home and in a simple affordable-style home. The following conclusions are drawn from the demonstration projects:

- 1) Standardized materials and code-approved prescriptive framing methods are needed;
- 2) steel framing is easily adapted to some difficult architectural details such as arched or vaulted ceilings;
- 3) pre-cut steel materials ordered from a “cut-list” provide significant time savings when properly planned;
- 4) plumbing and electrical trades were able to adapt to steel framing with little apparent cost impact;
- 5) a number of useful tools, fastening techniques, and fasteners are available to increase productivity with steel framing;
- 6) steel framing differs from wood framing primarily in the areas of fastening method, cutting techniques, and the need to maintain an “in-line” framing layout; and,
- 7) viewing or participating in the construction of a steel-framed house provides experience which is invaluable for anyone who is considering steel framing.

## APPENDIX

### Cut List - Demonstration Home Two

No.	Qty.	Description	Gauge	Length	Use	Comments
1	100	3-1/2 CEE	20	2'-0"	Stem & Pony	
2	30	3-1/2 CEE	20	1' 3-1/4"	Stem & Pony	
3	20	3-1/2 TD	20	30'-0"	Stem & Pony	Prefer 1.5" Track, if available
4	16	8JW	18	23'-3 1/2"	Floor (No Holes)	
5	6	8TD	18	10'-0"	Floor (No Holes)	Prefer 1.5" Track, if available
6	6	FC	20	20'-0"	Floor (No Holes)	
7	120	3-1/2 CEE	20	8'-0"	Exterior Walls	
8	30	3-1/2 CEE	20	7'-4"	Exterior Walls	
9	20	3-1/2 TD	20	30'-0"	Exterior Walls	Prefer 1.5" Track, if available
10	4	8 CEE	16	6'-9 1/2"	Header (No Holes)	
11	12	8 CEE	16	4'-9 1/2"	Header (No Holes)	
12	10	8 CEE	16	3'-9 1/2"	Header (No Holes)	
13	2	8 CEE	16	13'-4 1/2"	Header (No Holes)	
14	40	3-1/2 DWS	25	1'-3 1/4"	Interior Walls	
15	20	3-1/2 DT	25	30'-0"	Interior Walls	Prefer 1.5" Track, if available
16	6	4' x 8'-1"	22	Sheet	Interior Walls	
17	12	4 CEE	20	24'-0"	Truss "A" (No Holes)	
18	30	4 CEE	20	15'-4"	Truss "A" (No Holes)	
19	24	4 CEE	20	6'-3"	Truss "A" (No Holes)	
20	12	4 CEE	20	5'-8"	Truss "A" (No Holes)	
21	12	4 CEE	20	3'-0"	Truss "A" (No Holes)	
22	24	4 CEE	20	2'-9"	Truss "A" (No Holes)	
23	8	4 CEE	20	16'-0"	Truss "B" (No Holes)	
24	20	4 CEE	20	11'-0"	Truss "B" (No Holes)	
25	16	4 CEE	20	4'-3"	Truss "B" (No Holes)	
26	8	4 CEE	20	3'-10"	Truss "B" (No Holes)	
27	8	4 CEE	20	3'-0"	Truss "B" (No Holes)	
28	16	4 CEE	20	1'-9"	Truss "B" (No Holes)	
29	6	4 CEE	20	16'-8"	Truss "C" (No Holes)	
30	12	4 CEE	20	15'-4"	Truss "C" (No Holes)	
31	6	4 CEE	20	14'-7"	Truss "C" (No Holes)	
32	6	4 CEE	20	3'-0"	Truss "C" (No Holes)	
33	12	4 CEE	20	2'-2"	Truss "C" (No Holes)	
34	4	2-1/2 CN	20	12'-0"	Truss	
35	100	1-1/2 x 8"	18	1'-0"	Gusset	Angle shape (track with only one flange)
36	60	1-1/2 x 8"	18	3'-0"	Gusset	Angle shape (track with only one flange)
37	1	3.0" Flat coil	20	300'-0"	Collector strap	Or between 2.5 to 3.25 inches wide
38	24	8.9" Flat	20	10'-0"	Trim	Or between 8.5 to 9 inches wide
39	4	8.9" Flat	18	10'-0"	Block	Or between 8.5 to 9 inches wide
40	12	5.25" Flat	20	14'-0"	Brace	Use closest standard width to 5.25"
41	10	1-1/2 x 4" AN	20	10'-0"	Miscellaneous	For offset angle
42	50	1-1/2 x 1-1/2 AN	20	10'-0"	Brace	For offset angle
43	20	1-5/8 CN	20	12'-0"	Gable	Or closest size available
44	10	1-5/8 TD	20	10'-0"	Gable	Or closest size available
45	4	4 TD	16	16'-0"	Hip	