

BUILDING INNOVATION FOR HOMEOWNERSHIP



Prepared for:
U.S. Department of Housing &
Urban Development
Office of Policy
Development & Research

Prepared by:
Steven Winter Associates, Inc.
Building Systems Consultants
Norwalk, CT

Contract DU100C000005956
April 1998



PATH (Partnership for Advancing Technology in Housing) is a new private/public effort to develop, demonstrate, and gain widespread market acceptance for the “Next Generation” of American housing. Through the use of new or innovative technologies the goal of PATH is to improve the quality, durability, environmental efficiency, and affordability of tomorrow’s homes.

Initiated at the request of the White House, PATH is managed and supported by the Department of Housing and Urban Development (HUD). In addition, all Federal Agencies that engage in housing research and technology development are PATH Partners including the Departments of Energy and Commerce, as well as the Environmental Protection Agency (EPA) and the Federal Emergency Management Agency (FEMA). State and local governments and other participants from the public sector are also partners in PATH. Product manufacturers, home builders, insurance companies, and lenders represent private industry in the PATH partnership.

To learn more about PATH, please contact: PATH
Suite B133
Washington, DC 20410
202-704-4250 (fax)
e-mail: pathnet@pathnet.org

BUILDING INNOVATION FOR HOMEOWNERSHIP



FOREWORD

I am pleased to present this collection of award-winning, innovative housing projects, which have contributed to our national effort to help create 8 million new homeowners by the start of the new century. One of the keys to homeownership is affordable housing, and greater affordability can be achieved by reducing the “bricks and mortar” costs of homebuilding. Invention, innovation, new materials, and improved means of construction have often yielded more affordable homes.

In support of the initiative of the National Partners in Homeownership to find ways to lower the financial threshold of homeownership, HUD instituted the Building Innovation for Homeownership Program to recognize new ideas in housing development, design, and construction that lead to greater affordability.

More recently, the President asked HUD to lead a larger housing technology effort — PATH (Partnership for Advancing Technology in Housing). PATH is a new private/public effort to develop, demonstrate and gain widespread market acceptance for the “Next Generation” of American housing that will result in improved quality, durability, environmental efficiency, and affordability for tomorrow’s homes.

This book documents more than three score innovative, affordable projects from around the country and how they were achieved. It is my hope that the homebuilding industry will freely adopt these ideas to lower housing costs through innovation, and to make the dream of homeownership a reality for more Americans.

resource and will lead to affordable, high quality rehaz

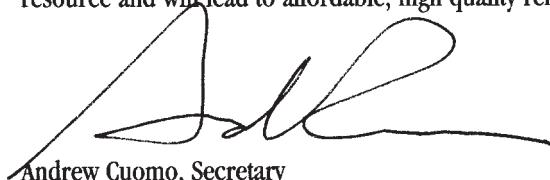











Andrew Cuomo, Secretary
Andrew Cuomo, Secretary

US Department of Housing and Urban Development

CONTENTS

FOREWORD **4**

INTRODUCTION **6**

1. MODULARS  **10**
 2. HUD CODE (MANUFACTURED)  **24**
 3. ENERGY EFFICIENT  **44**
 4. PANELIZED CONSTRUCTION  **60**
 5. STRUCTURAL INSULATED PANELS  **74**
 6. STEEL FRAME  **88**
 7. COHOUSING  **100**
 8. MASONRY/CONCRETE  **120**
 9. SUSTAINABLE DESIGN AND CONSTRUCTION  **138**
 10. SITE DESIGN  **156**
- ACKNOWLEDGMENTS **178**

INTRODUCTION: Building Innovation for Homeownership

The Building Innovation for Homeownership (BIH) Program is a major initiative of the National Partners in Homeownership to expand the possibility of the “American Dream”: to own a home. The Partners—65 public, private, and nonprofit organizations convened by President Clinton—have come together to initiate various joint projects and actions that collectively will expand housing opportunities by adding 8 million new homeowners by the year 2000. This goal is to be achieved through the active collaboration of public and private housing industry groups.

The Partnership has made cutting the cost of housing one of its basic strategies for expanding homeownership. Lower development and production costs translate into more affordable housing prices, increasing the pool of eligible homebuyers. A key to encouraging the adoption of such innovations is awareness and education. As described in its mission statement, *Partners in the American Dream*, the Partnership seeks to “lead a public/private effort to accelerate adoption of technological innovation in the homebuilding industry to increase the use of innovative new technologies and produce less costly and more energy- and resource-efficient new homes.” The awards program and this book are part of that effort.

The BIH Program was created to recognize housing projects across America that employ innovative homebuilding technology, design, and development to make homeownership a reality. An awards program, with winners selected by Partner participants, would highlight innovations that can



easily be used by designers, developers, and contractors around the country. Eligible projects were those that used generally available, non-experimental technologies and techniques that vary significantly from approaches usually taken in housing construction. Projects also had to be below the median cost of new single-family housing in the region where they were constructed. The program sought a diversity in applicants and technologies. Non-profit developers and others serving special user and very low-income needs were encouraged to apply. Manufactured, modular, and industrialized housing as well as site-built technologies qualified for the BIH Program. Applicants to the program came from across the U.S. The projects were juried by a Partnership Board and representatives of HUD. This jury selected 63 award winners.

In addition to the recognition of a national awards program, the National Partners are committed to working with the developers of these projects to assure that they are successfully and quickly completed and offer the benefits of homeownership to the broadest range of potential buyers. Many Partners, or their member organizations, offer extensive programs that can provide potential homebuyers with financing options that are not otherwise readily available in the marketplace. A number of Partners have agreed to make these programs available to winning projects. HUD is also committed to assuring that existing FHA, Community Development Block Grant (CDBG), HOME, and counseling programs support these projects.



The winning projects, as documented in this book, represent a broad diversity in technique as well as sponsorship. All the selected BIH projects are below (some significantly) the median sales price for new homes in their market area. In fact, it appears that there may be greater innovation and experimentation going on in the affordable housing market than in the middle- or upper-income markets. A large number of the projects, 24, employ factory-built components, including seven HUD-Code (manufactured housing) developments.

Twenty-six of the award-winning projects were developed by non-profit sponsors. Habitat for Humanity International, the initiative to help people to house themselves, should be especially commended for its willingness to introduce new technology. Nine Habitat developments using a variety of techniques to reduce costs were chosen, including adobe, steel framing, straw bale, “green” building materials, and mortarless concrete blocks.

Twenty-five of the innovative developments are part of inner-city neighborhood revitalization efforts. In addition, two Native American projects as well as a major Colonias project, “La Frontera,” were awarded.

The winning projects are organized according to the innovations they employ, which lower the cost of housing to bring it within reach of prospective new homeowners. The innovations include: modular construction, energy-efficient design and construction, structural insulated panels, innova-



tive site design or development, steel framing, sharing of resources through cohousing, panelized construction, innovative masonry or concrete construction, sustainable or “green” design and construction, and HUD-Code manufactured housing. Each of the following chapters describes the category of innovation, and documents through words, drawings, and photographs the specific qualities of each award-winning project. Each innovation category is identified by an icon, which are shown below. It should be noted that most of the projects in this book incorporate a number of innovations. The projects are organized by the category of innovation that they most strongly represent. Additional icons on each project identify other applicable innovations. Also included is information on project costs, financing, and where one can gain further information on the innovative technologies featured.

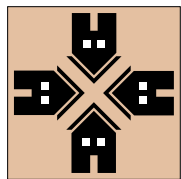

Co-Housing

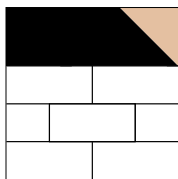

Concrete

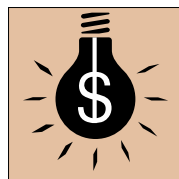

Energy

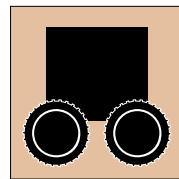

Manufactured

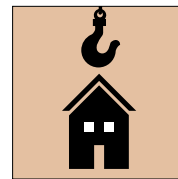

Modular

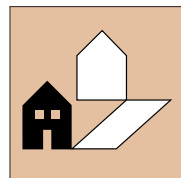

Panelized

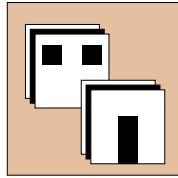

SIPS

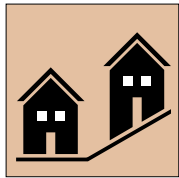

Site

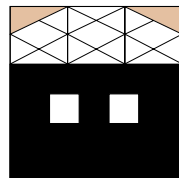

Steel

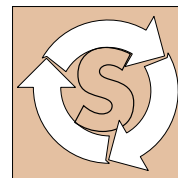

Sustainable

1. MODULARS

Modular housing employs building technology that, while not exactly new, has yet to be widely used by the market. In recent years modular construction has a significant and stable share of the home construction industry. Modular housing consists of two or three three-dimensional “boxes” that are shipped complete (or nearly complete) from the factory and are connected together on site. The most common configurations for single-family detached housing are two set side-by-side and two-over-two four-section units. Modular units have also been used to produce attached and multi-story housing, such as the West-of-Pennsylvania project. Today, modular homes can be virtually indistinguishable from site-constructed “stick-built” houses. Wood framing is the predominant structural technique in modular housing, although steel and stressed-skin panels are also used. The advantages to modular housing are the reduced construction time on site, greater security from pilferage on the building site because the units arrive complete, lower construction costs than conventional homebuilding, and better quality control over the finished product because it is produced in a factory.

West of Pennsylvania	12
Pine Ridge	14
McAfee Homes	16
Horizon Village	18
Forest Grove	20
Winn House	22

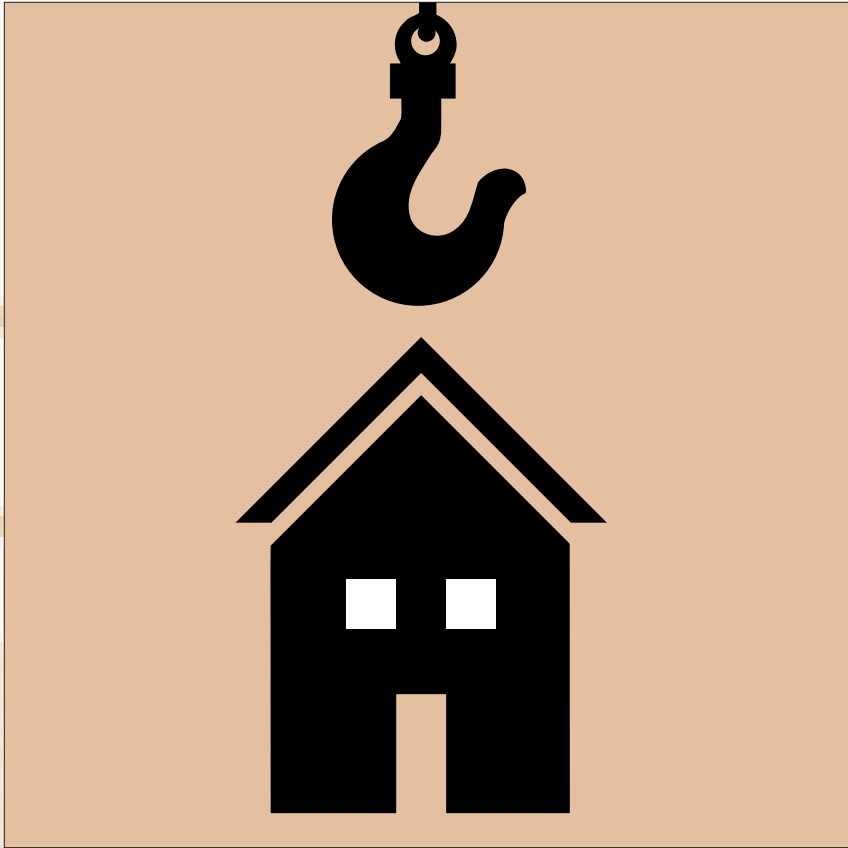

WEST OF PENNSYLVANIA

Brooklyn, New York

This 700-unit development is scattered on a variety of sites in the East New York section of Brooklyn, New York. It is the first phase of a larger development that eventually will total 1,200 houses. Modular units, built by Capsys and assembled on site by Monadnock Construction, will be used throughout the development. The modules are steel-framed, with insulation placed between the frame and the exterior cladding to give these buildings better thermal performance. At 18 feet, these modules are wider than the standard 14-foot-wide unit, which means that fewer units are used to make a single house, and result in more spacious interiors. These units are also completely finished in the factory, cutting work to a minimum of 10 percent to 20 percent of that usually conducted on site for modular construction. Costs have been held down by the modular construction and by the innovative financing of East Brooklyn Congregations, a consortium of church groups that pool resources and raise subsidy for housing developments. EBC has set up a \$5 million trust to be used for revolving no-interest construction loans. The city provided land and \$20,000 of subsidy for each house.

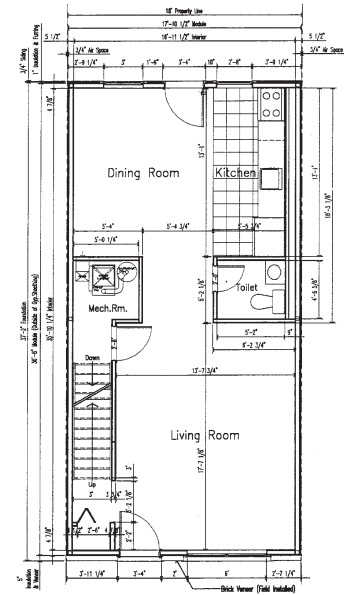

1 Floor (Left)

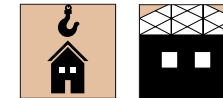

PROJECT PROFILE

Housing Type

Single-family attached rowhouses on an urban infill sites.

Technology and Design

Wider than standard rigid steel-framed modular construction, completely factory finished, contributes to compressed construction schedule and better energy performance.

Project Size

700 units at 1,338 square feet.

Housing Price

Units average \$71,000; 62 percent of reported median.

Financing

Nonprofit developer provides no-interest construction loans; city provides land and \$20,000 subsidy per unit.

PROJECT CREDITS

East Brooklyn Congregations

(*developer*), Ken Thorburne (*lead organizer*);

Monadnock Construction

(*builder*), Nicholas Lembo (*president*);

Capsys,

(*modular manufacturer*);

Roman Catholic Diocese of Brooklyn and Queens,

Bishop Thomas V. Daily;

Mission Synod Lutheran Church,

Atlantic District, David Benke (*president*);

St. Paul Community Baptist Church,

Rev. Johnny Ray

Youngblood (*pastor*);

Community Preservation Corporation,

Michael Lappin, (*president*);

City of New York,

Hon. Rudolph Guliani (*mayor*), Liliam Barrios-Paoli (*New York commissioner of Housing*).

Additional Technology Information

Modular Building Systems Council
 Building Systems Councils
 National Association of Home Builders
 1210 15th Street, NW
 Washington, DC 20005
 800-368-5242, ext. 576 (phone);
 202-861-2141 (fax)

Additional Project Information

East Brooklyn Congregations
 124 Sackman Street
 Brooklyn, NY 11233
 718-498-4095 (phone); 718-485-5537 (fax)

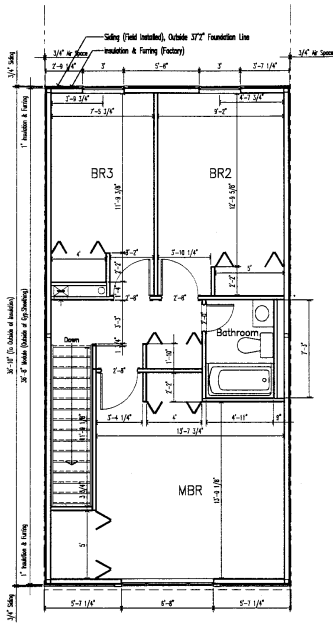

2 Floor (Left)



West of Pennsylvania's steel-framed, wide modules are factory built, moved to the site, and set into place, resulting in a neighborhood with an urban scale.



PINE RIDGE

South Paris, Maine

This development of 10 modular homes on a rural site in Maine has a number of innovative features that reduce costs and encourage good land management. The site plan uses a cluster arrangement that groups the homes close together, allowing the remainder of the parcel to be held in common as undeveloped woods. This gives the clustered homes a buffer against future development. The cluster design also results in savings on site development and infrastructure costs. The houses—capes, ranches, and split levels—are modular units that arrived at the site approximately 90 percent complete. The developer, a nonprofit agency, offers an “Ownership Readiness” program that assists buyers in the financing process, helps families to budget, and to take care of their homes. Buyers may put down as little as \$1,000 for a fixed-rate mortgage, and housing prices are subsidized from \$17,000 to \$45,000 according to the income and need of the buyers. The town supported the development in the form of a grant for infrastructure and waived permit fees.



PROJECT PROFILE

Housing Type

Single-family units on individual lots.

Technology and Design

Modular construction for houses in a variety of styles, sited on individual lots that are clustered together to lower infrastructure costs and to allow common space to surround the development as a natural buffer.

Project Size

10 units, averaging 1,000 square feet.

Housing Price

Units average \$61,500; 72 percent of reported median.

Financing

Low downpayment program, assistance from the local government for infrastructure costs, and a buyer assistance program.

PROJECT CREDITS

Community Concepts, Inc., Matthew M. Smith, Dennis J. Lajoie, Debbie Trenoweth, Linda Dube;

Community Development Services, Tom Lewis, Joseph Ponzetti;

Maine State Housing Authority, Tom McDonald, David Lakeri (*director*), Kim Leopold;

Keiser Homes, Ed Keiser, Todd Truman, Ray Atkisson;

Norway Savings Bank, Ross Tardiff, Bill Catchel;

Searles Excavation, Gary Searles;

Town of Paris, John White.



Additional Technology Information

Modular Building Systems Council
Building Systems Councils
National Association of Home Builders
1210 15th Street, NW
Washington, DC 20005
800-368-5242, ext. 576 (phone);
202-861-2141 (fax)

Additional Project Information

Community Concepts, Inc.
Market Square, P.O. Box 278
South Paris, ME 04281
207-743-7716 (phone); 203-743-6513 (fax)



Modular homes of different styles distinguish Pine Ridge. Modules are lifted into place by crane and roof construction is completed, resulting in finished houses that appear to be site-built.



McAFEE HOMES

Wichita, Kansas

The McAfee housing initiative includes modular building technology, a program of inner-city job creation in the housing manufacturing plant, and the construction of affordable units on distressed, scattered sites in Wichita. Charles McAfee, an African American architect and entrepreneur, designed the units and manufactures them in his own factory, employing local people to build the houses and their own skills. McAfee has also developed approximately a dozen building sites, scattered through inner city neighborhoods. Houses have an average selling price of \$70,000, far below the \$112,000 median for new construction. The modular units are constructed in factories located not far from the development sites, and then shipped a short distance for assembly. The homes include heat pumps and energy-saving appliances to keep operating costs low, along with durable, low-maintenance materials. The McAfee program not only provides affordable housing with modular technology, but also provides jobs and builds an economic base in the inner city.



PROJECT PROFILE

Housing Type

Single-family homes on scattered urban infill sites.

Technology and Design

Modular units are used on distressed urban properties to revitalize neighborhoods. Manufacturer employs local people in jobs program. Designs are a combination of traditional and contemporary.

Project Size

12 units, averaging 1,200 square feet.

Housing Price

Units are offered for an average of \$70,000; 63 percent of reported median.

Financing

Conventional mortgages.

PROJECT CREDITS

Charles McAfee Architects (*engineers, program managers, planners, manufacturers*);
American National Bank;
Above and Beyond Services, Inc.;
Alford Electric Company;
Master Air Control, Inc.;
Newton Electric.



Additional Technology Information

Modular Building Systems Council
Building Systems Councils
National Association of Home Builders
1210 15th Street, NW
Washington, DC 20005
800-368-5242, ext. 576 (phone);
202-861-2141 (fax)

Additional Project Information

McAfee Manufacturing/JM Limited
1011 East 13th Street
Wichita, Kansas 67214
316-267-3565 (phone); 316-267-3593 (fax)



On site, workers prepare concrete foundations to receive the modules. In the factory, modules are constructed under controlled conditions, shipped to the site, and then set into place.

HORIZON VILLAGE

Newark, New Jersey

Horizon Village is an inner city development in Newark, which has seen little new housing construction since the riots of a generation ago. The 27 duplexes are of modular construction, with added energy-saving features such as double-pane windows, caulked electrical receptacles to cut air infiltration, and boosted insulation. Exterior materials are durable and low-maintenance. The units are sited to encourage the concept of “defensible space”: close to the street, fences, high visibility of the street from the units, no outside access to unit crawlspaces. Duplexes contribute to housing affordability. Homebuyers become landlords, learn about property management, and have a second-income source. Units must be rented to low-income families under certain income levels for a period of 15 years. There are also constraints on profit from resale of the units and the income level of the buyers. Buyers were counseled through the mortgage process. New Jersey’s Urban Homeownership Recovery Program provided a grant for the development, while HUD provided a grant from the HOME program for a second mortgage. Horizon Village was developed by a for-profit/nonprofit partnership.

PROJECT PROFILE

Housing Type

Duplex units on an inner-city site.

Technology and Design

Modular construction with energy-saving features and low-maintenance materials. Exterior design fosters “defensible space.”

Project Size

54 units comprised of 27 duplexes, averaging 1,100 square feet.

Housing Price

Units offered for \$80,000; 32 percent of reported median.

Financing

Support from state, nonprofit, and commercial sources for construction loans.

PROJECT CREDITS-

JP Affordable Housing, Inc. (*project developer*);

Community Urban Renewal-Enterprise (*project sponsor*);

State of New Jersey, UHORP (*project funding*);

HUD (*project funding, HOME*);

City of Newark;

Summit Bank and NJHMFA (*construction and end loan financing*);

Inner City Construction, Inc. (*general contractor*).

Modular construction compresses construction time and reduces pilferage on such urban sites as Horizon Village. Modules can be maneuvered into place on narrow infill sites, which might restrict other forms of construction technology.



Additional Technology Information

Modular Building Systems Council
Building Systems Councils
National Association of Home Builders
1210 15th Street, NW
Washington, DC 20005
800-368-5242, ext. 576 (phone);
202-861-2141 (fax)

Additional Project Information

JP Affordable Housing, Inc.
152 Central Avenue
Jersey City, NJ 07306
201-217-0855 (phone); 201-217-0336 (fax)



FOREST GROVE

Royal Oak Township, Michigan

In a distressed neighborhood that had not seen any new mortgage activity in 20 years, these new modular units are helping to raise property values while providing much needed affordable housing. The modules arrive on the site nearly complete, with some interior and exterior finish work required. Modulares allow swift erection and thwart site theft of materials and vandalism in distressed neighborhoods. The modular houses with three bedrooms and two baths are offered at below median prices to spur development in this moribund real estate market. To create more of a sense of a suburban development, the houses are placed on two narrow, annexed lots, which were acquired from the city. This allows more space around the units and allows these ranch-style homes to face the street. The nonprofit developer, Venture, secured federal HOME funds to subsidize the houses. Venture is the first nonprofit in Michigan to use modular units.



PROJECT PROFILE

Housing Type

Single-family homes on scattered infill sites.

Technology and Design

Modular units are used on distressed urban properties, sited with the widest side toward the street to maximize open space around the house.

Project Size

11 units, averaging 1,100 square feet.

Housing Price

Units are offered for an average of \$41,000; 38 percent of reported median.

Financing

HOME funds used for first-time homebuyer mortgages; involvement of nonprofit community housing development organization.

PROJECT CREDITS

Venture, Inc. (*nonprofit Community Housing Development Organization*), Robert Conaway (*chair*), Diana Stahl (*president*), Michelle Poepppe (*program director*);

Oakland County, Michigan, L. Brooks Patterson (*executive director*);

Oakland County Community Development Division, Karry Rieth (*manager*);

UNIPROP (*contractor*), Paul Zoltoff (*president*), Terry Winter (*vice president*);

Township of Royal Oak, Michigan, Jerry Saddler (*supervisor*); Redman Homes, (*supplier*).

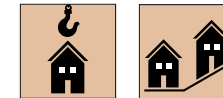

Additional Technology Information

Modular Building Systems Council
Building Systems Councils
National Association of Home Builders
1210 15th Street, NW
Washington, DC 20005
800-368-5242, ext. 576 (phone);
202-861-2141 (fax)

Additional Project Information

Venture, Inc.
196 Oakland Avenue
P.O. Box 430598
Pontiac, MI 48343
810-858-5190 (phone); 810-858-5158 (fax)



Reclaimed lots allowed Forest Grove modulares to be positioned longways to the street. Modules arrive on site and are moved into place, spliced together, and receive exterior finishes.

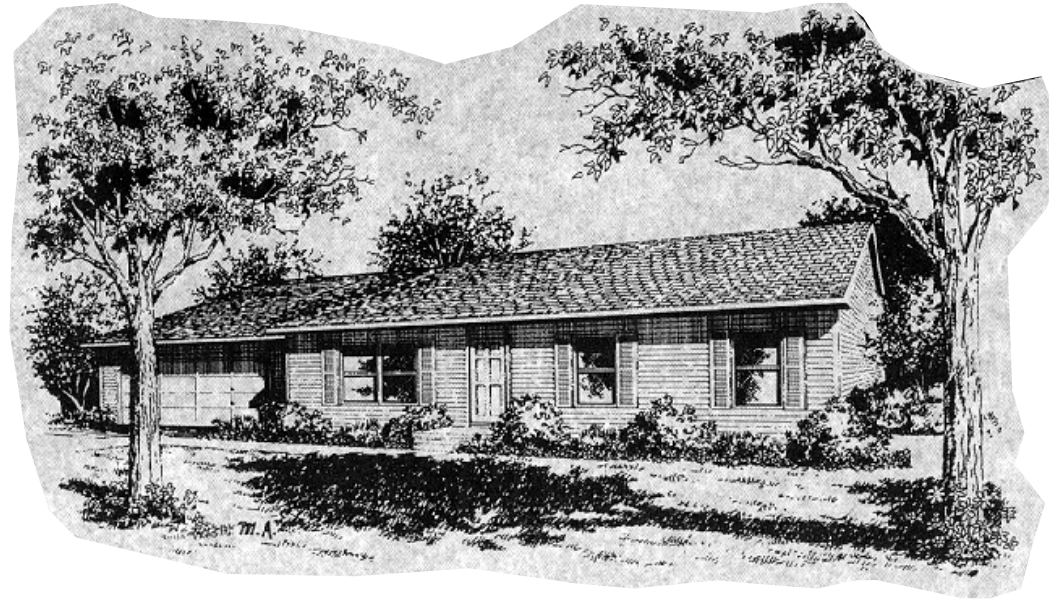

WINN HOUSE

West Deerfield, Massachusetts

The Winn House is one of more than a dozen that the Home Store has built around the New England region. The house's construction is modular, but what really makes it innovative is the Universal Design features that it incorporates. The Home Store offers this model as an alternative to adapting existing houses to accommodate the disabled. The design for the house was developed by the Home Store and the Center for Accessible Housing at North Carolina University. It uses four modular units to achieve a barrier-free design, with one living room/foyer module, one dining room/kitchen module, and two bedroom modules. Among the Universal Design features are level entry approach; covered porch; package shelf; low threshold doorways; lever door handles; five-foot turning radius in kitchen and baths; kneespace under sinks; 42-inch-wide hallways; 32-inch minimum doorways; easy to reach rocker electrical switches and outlets; tub with integrated transfer seat; anti-scald tub/shower controls; and grab bars. Energy-efficient design includes low-e glazing and boosted insulation in 2x6 exterior walls.

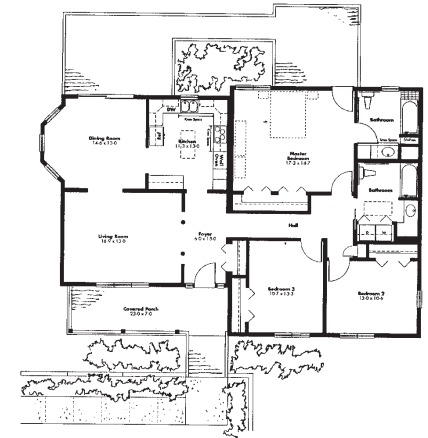

PROJECT PROFILE

Housing Type

Single-family detached houses on scattered sites.

Technology and Design

Modular construction, assembled from four factory-made modules and trucked to the site; Universal Design principles and equipment used throughout to allow access for the disabled.

Project Size

14 units averaging 1,600 square feet.

Housing Price

Units average \$135,000; 80 percent of reported median.

Financing

Low down-payment construction financing program; low-interest loans for first-time homebuyers.

PROJECT CREDITS

The Home Store, Inc., Andy Gianino, Ph.D. (*president*);
The Center for Universal Design, North Carolina State University, Ron Mace, FAIA (*director*).



Additional Technology Information
Modular Building Systems Council
Building Systems Councils
National Association of Home Builders
1210 15th Street, NW
Washington, DC 20005
800-368-5242, ext. 576 (phone);
202-861-2141 (fax)

Additional Project Information
The Home Store
73 State Road
Box 300
Whately, MA 01093
800-974-1266 (phone); 413-665-1122 (fax)



Universal Design features for accessibility distinguish this single-story home, made up of four modular units that, when assembled, appear as a site-built home.



2. HUD CODE (MANUFACTURED)

HUD Code, or manufactured houses, are an outgrowth of the mobile home industry. Because they are built in a factory and then transported virtually complete to a site, the design and construction of these units are governed by the Manufactured Home Construction and Safety Standards, known as the HUD Code, which is applicable in jurisdictions across the country. HUD-Code homes are most commonly single-width units (up to 14' wide for transportation on highways) or double-wides, which are set next to each other on the site. While one of the characteristics of the manufactured home is that it remain “mobile” with an integral chassis, recent developments have seen HUD-Code houses stacked as two-story homes (such as the New Colony project), made up of more than two sections, and including site-built additions such as porches and garages. More units are now being placed on permanent foundations instead of temporary foundation “tie downs.” Another new development in manufactured homes is how they are financed. Traditionally, personal property loans at high interest rates were used; today some HUD-Code developments on occupant-owned (not leased) land with permanent foundations can qualify for conventional mortgages, which lowers the cost of housing. The advantages of manufactured homes include swift erection, low initial cost, resource conservation through factory production, and minimal site work.

Wisteria	26
New Colony	28
Hillcrest	32
Elmhurst	36
LongView	38
High Meadows	40
Canterbury Communities . . .	42

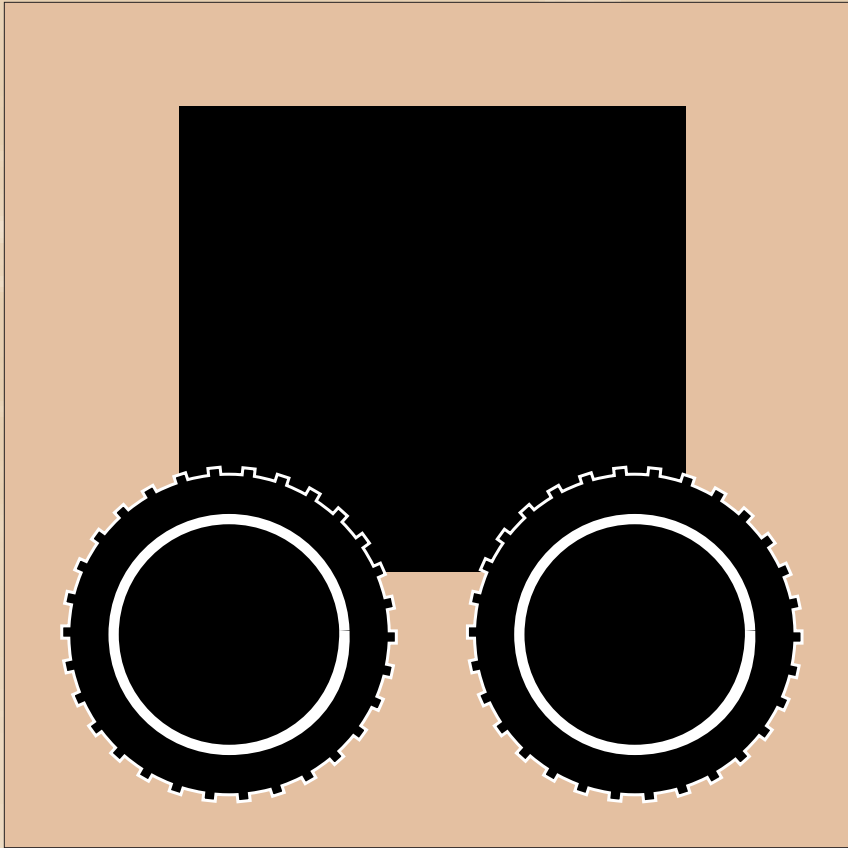

WISTERIA

Petaluma, California

Wisteria blends factory-built manufactured homes with site-built embellishments such as attached garages and entryways. The completed homes are virtually indistinguishable from similar, stick-built houses. The use of HUD-Code construction represented a 20 percent saving over conventional construction, without sacrificing quality or durability, according to a study commissioned by the city prior to Wisteria's development. The units are 90 percent complete when they leave the factory. Site additions such as garages, entryways, foundations, and landscaping are contracted to the local job force and stimulate employment in the area. All homes have kitchens that face the street. The designer mixed four kitchen units (with distinctly different exterior appearances) with three garage elevations. Garages were carefully placed at two specified locations towards the front of the homes, forming inviting foyers or courtyard entryways secured by the character of redwood arbors. Fee simple land use and zero-lot-line planning reduce land costs, adding to affordability. Durable, low-maintenance materials on the exterior lower operating costs.

PROJECT PROFILE

Housing Type

Single-family detached houses in a suburban development.

Technology and Design

Houses are constructed of HUD-Code units, with site-built features such as garages and porches.

Project Size

28 units ranging from 1,269 to 1,386 square feet.

Housing Price

Units are offered for \$136,000; 62 percent of reported median.

Financing

Public, private, and nonprofit partnerships in the development; Housing and Community Development BEGIN funding; developed by a nonprofit organization; city made land available.

PROJECT CREDITS

City of Petaluma, M. Patricia Hilligoss (*mayor*), Michael Davis (*city councilperson*);

Modular Lifestyles, Inc. and Cirus Development, Inc.

(*designer/builder*), Otis M. Orsburn (*president*);

The Karsten Co., (*manufacturer*), Andy Karsten, (*president*);

Northbay Ecumenical Homes (*non-profit developer*), Clark Blasdell (*chief executive officer*);

Burbank Housing Development Corp., Arnold Sternberg (*executive director*).



Additional Technology Information

Manufactured Housing Institute
2101 Wilson Blvd., Suite 610
Arlington, VA 22201-3062
703-558-0652 (phone); 703-558-0401 (fax)

Additional Project Information

Modular Lifestyles
16 Richards Drive
Roseville, CA 95678
916-782-3829 (phone); 916-783-0084 (fax)



HUD-Code units are craned into place, while site-built additions such as garages and porches are added to give these Wisteria houses the appearance of conventional construction.



NEW COLONY VILLAGE

Jessup, Maryland

This planned community of manufactured homes makes several breakthroughs in housing technology and land development. The predominantly two-story houses, averaging 1,300 square feet, are HUD-Code construction, sitting on permanent foundations. While this type of construction is usually restricted to one-story houses, this development uses units with wood chassis and removable wheels, axles, hitches, and steel supports. This allows the manufactured houses to be stacked as modulars would be, resulting in two-story units on leased land, with site-built elements such as porches. The local building authority approved this construction technique, and the Maryland state legislature passed new laws that exempt manufactured home developments from land-lease redemption. Long-term leases of 50 years allow for conventional loan programs, thus making the manufactured home loan comparable to that for conventionally built homes. Other savings were realized through greater unit densities, and reduced housing costs to buyers and reduced property taxes through land lease.



PROJECT PROFILE

Housing Type

Detached single-family on suburban lots.

Technology and Design

Single-story and two-story HUD-Code manufactured homes on permanent foundations, with site-built add-ons such as garages, porches, and decks. A variety of traditional designs.

Project Size

416 units, averaging 1,300 square feet.

Housing Price

Units average \$105,000; 66 percent of reported median.

Financing

Conventional private development with long-term land lease to homeowners.

PROJECT CREDITS

Corridor 1 LLP, Wayne Newsome and Mark Levy (*developers*);
Select Housing Associates, Gary W. Pomeroy (*manufactured housing consultant*);
Hackworth Architecture-Planning, Greg Hackworth and Steve Dona (*land planners and architects*);
Schult Homes Corp., Warren Keyes (*manufactured housing producer*);
A. Gail Boorman & Associates, Gail Boorman (*landscape architects*).



Additional Technology Information

Manufactured Housing Institute
2101 Wilson Blvd., Suite 610
Arlington, VA 22201-3062
703-558-0652 (phone); 703-558-0401 (fax)

Additional Project Information

Select Housing Associates
3300 Irvine Avenue, Suite 225
Newport Beach, CA 92660
714-261-2273 (phone); 714-261-7343 (fax)

Manufactured units arrive on the site with wheels and are stacked not unlike modular construction. Permanent foundations are also a feature that enhances durability and lowers financing costs.

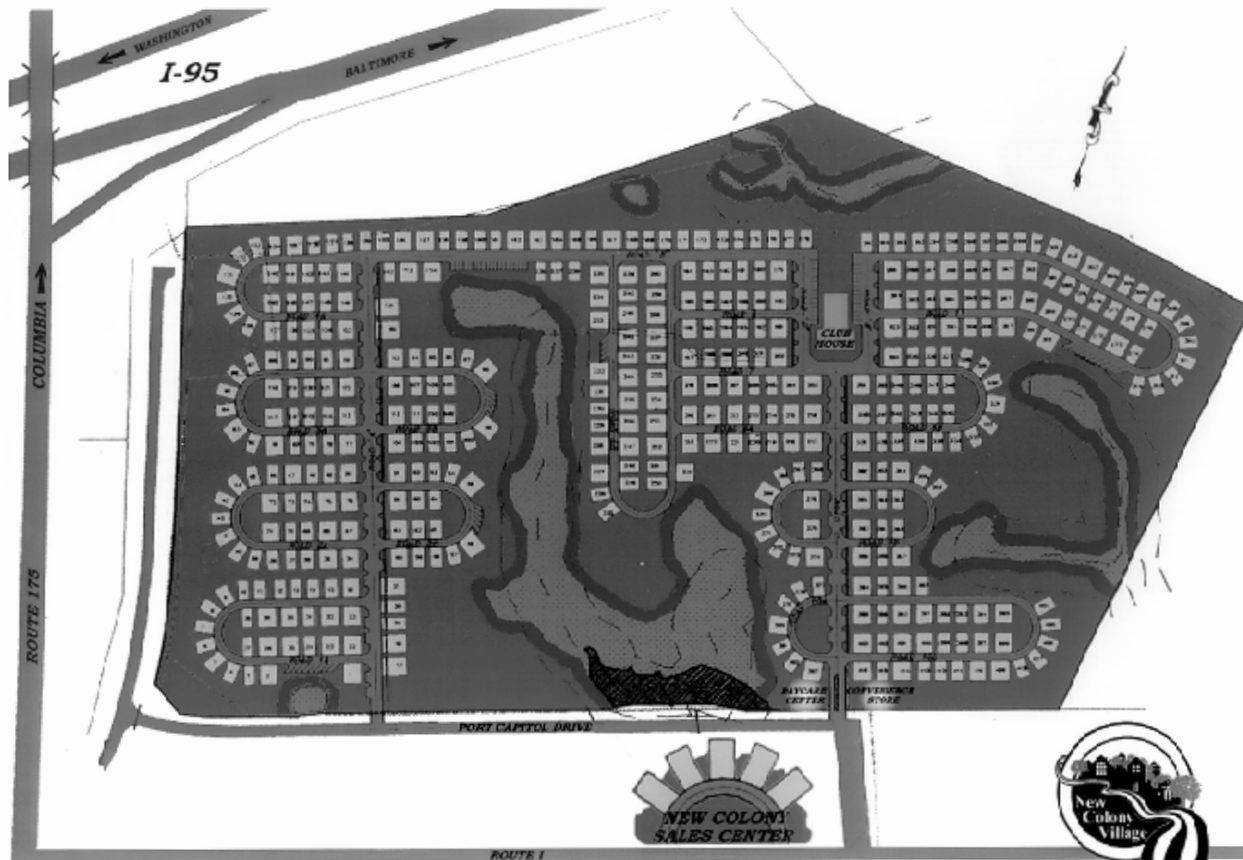



After stacking, HUD-Code units are finished with maintenance-free materials, while features such as porches are added. The result is a community that appears to be conventional construction.



HILLCREST

Uncasville, Connecticut

Hillcrest is a community for residents 55 and over planned with affordable units, in a suburban setting. The 208 homes are HUD-Code manufactured units and incorporate a unique technical feature: the patented Lindsay Unified Floor System. With a depth of no more than 21 inches, the floor can accommodate all electrical, plumbing, and heating runs. The unit manufacturer, New Era Homes, uses a single-trunk duct system, coupled with efficient insulation, to deliver better indoor air quality and temperature control. Floors/walls/ceilings have R-values of 19/26/38. Within the building, trusses, dimensional lumber, and steel I-beams are “unified” to create a stronger floor system. Concrete perimeter foundations are used instead of the more common pier foundations and foundation skirting for HUD-Code housing, which gives these units the appearance of site-built homes. Garages, porches, sunrooms, and workshops are site-built additions which further enhance the utility and appearance of these homes.

PROJECT PROFILE

Housing Type

Single-family detached units on individual lots.

Technology and Design

HUD-Code manufactured housing with concrete perimeter foundations. The houses use a patented, “unified” floor system to accommodate all utility runs, and a ducting system to deliver heat and ventilation more efficiently.

Project Size

208 units, averaging 1,290 square feet.

Housing Price

Units average \$112,000 on leased land; 86 percent of reported median.

Financing

Conventional manufactured housing mortgages with no federal or state subsidy.

PROJECT CREDITS

Jensen’s, Inc. (*developer*), Kristian Jensen III (*president*), Nick Verzillo (*project manager*), Shirley Sherman (*sales consultant*), Shaun Donahue, Tim Whitacre (*landscaping*), Lou Fernandes (*housing construction*);

New Era Building Systems (*housing manufacturer*), Elliot J. Fabri (*president*), Albert W. Peters (*general manager*), Chris Hepfer (*engineering manager*);

Lindsay Industries, Fred Lindsay; **LaSalle Air Systems-HVAC**, Karl Whitehead.

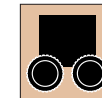

Additional Technology Information

New Era Building Systems, Inc.
451 Southern Avenue
P.O. Box 269
Strattanville, PA 16258
800-678-5581 (phone); 814-764-5658 (fax)

Additional Project Information

Jensen’s Inc.
246 Redstone Street
P. O. Box 608
Southington, CT 06489
860-793-0281 (phone); 860-793-6909 (fax)

Improved HVAC system is a feature of this manufactured home, which uses a Lindsay floor system. Units are toted to site and roofs are swung into place after units are set on permanent foundations.

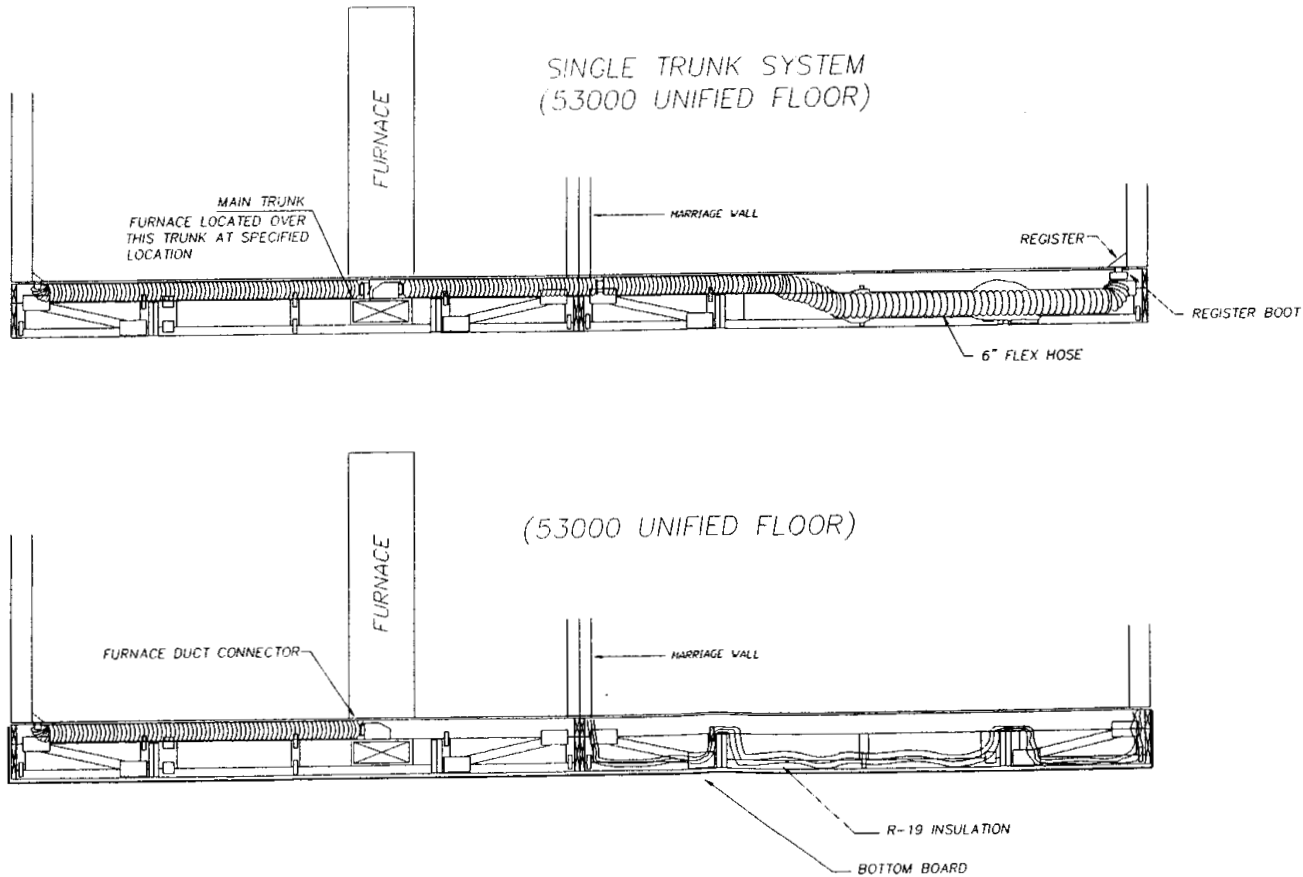
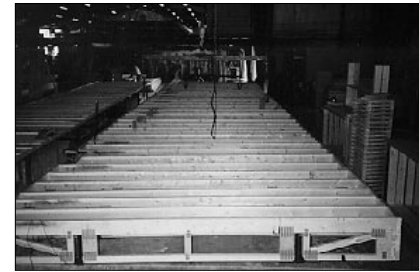



Homes feature L-shaped plans achieved with two or more manufactured units set at angles. Features such as porches and decks are added after units are in place. Interiors are spacious.



ELMHURST URBAN INFILL HOUSING

Oakland, California

Elmhurst is a run-down neighborhood in Oakland, California, that has a number of empty lots and abandoned houses. This initiative is an effort to fill in some of the neighborhood’s “missing teeth” and by so doing help to raise property values and arrest further decline. The units are offered for \$90,000, which is approximately 51% of the median price for new housing construction. The developer and architect, Paul Wang, is working on six sites and has designed manufactured housing units with false fronts that appear to have conventionally constructed pitched roofs. Garages, pitched roofs, and porches are site-built, with private patios located behind the garage wing. The houses are sympathetic in size, scale, and architectural style to adjacent older homes. The city is in partnership with the architect to develop these infill sites, and the project has been given support by the local neighborhood association.



PROJECT PROFILE

Housing Type

Detached single-family units on urban infill sites.

Technology and Design

HUD-Code manufactured housing, with units oriented lengthwise into the narrow urban sites. Gables, porches, and other features are then added to the unit.

Project Size

6 units, 810 square feet.

Housing Price

Units are \$90,000; 51 percent of reported median.

Financing

Conventional manufactured housing mortgages, with local government and nonprofit support.

PROJECT CREDITS

Paul Wang & Associates Architects

(architect/developer);

Silvercrest, Western Homes Corp.

(housing manufacturer);

Landmark Construction *(on-site contractor);*

City of Oakland Community and Economic Development Agency,

Jeff Angell *(staff-in-charge);*

African American Development Association, Rafeeq Najj *(community liaison);*

City of Oakland City Council, Committee of Economic Development, Community Development and Housing;

City of Oakland, Dezie Woods-Jones *(Elmhurst District City council member);*

City of Oakland Elmhurst Neighborhood Association.

Additional Technology Information

Manufactured Housing Institute
2101 Wilson Blvd., Suite 610
Arlington, VA 22201-3062
703-558-0652 (phone); 703-558-0401 (fax)

Additional Project Information

Paul Wang & Associates Architects
950 Regal Road
Berkeley, CA 94708
510-524-9393 (phone); 510-524-9394 (fax)

Elmhurst units arrive at the site virtually complete, with porches added after setting the manufactured homes on foundations. Scale is similar to that of adjacent existing homes. Interiors offer open plans.



LONGVIEW

Longmont, Colorado

LongView is a 400-home land-lease residential community that provides first-time homebuyers with affordable, manufactured homes. The land-lease arrangement enables the community to have on-site management and amenities such as a community lodge and parks. The land is offered through a “lifetime” lease that the homebuyer renews annually for as long as they choose to live at LongView. The 80-acre community is planned around a community center with nature walks, parks, trails, and water courses. The units themselves are HUD-Code manufactured homes by Fleetwood Enterprises, a nationally reputable housing manufacturer. The houses are delivered to the site and then anchored to a raft slab foundation. Site-built garages and decks are added to the manufactured houses to give them a stick-built appearance. The houses also incorporate energy-efficient features such as 2x6 framing with R-22/19/37 in floors/walls/ceilings. The first 88 homes are now complete, with the entire 400-home development scheduled for completion by 2000.



PROJECT PROFILE

Housing Type

Single-family detached houses on a leased land.

Technology and Design

HUD-Code manufactured houses on raft slab foundations, with site-built garages and porches.

Project Size

400 units averaging 1,450 square feet.

Housing Price

Units offered for an average of \$68,000; 48 percent of reported median.

Financing

Low down payment of 5 percent; monthly mortgages of less than \$800.

PROJECT CREDITS

McStain Enterprises, Inc. (*developer*), John C. Fernie (*vice president*);
Fleetwood Enterprises (*housing manufacturer*);
Chateau Communities (*manager*);
Don Westphal (*planner*).



Additional Technology Information

Manufactured Housing Institute
2101 Wilson Blvd., Suite 610
Arlington, VA 22201-3062
703-558-0652 (phone); 703-558-0401 (fax)

Additional Project Information

McStain Enterprises
75 Manhattan Drive, Suite 1
Boulder, CO 80303
303-494-5900 (phone); 303-494-4933 (fax)



Longview's factory-produced units are set on permanent raft-slab foundations, which improve durability and performance. Features such as garages and porches are added after units are in place.



HIGH MEADOWS

Florence, Colorado

A large development, High Meadows has an innovative mixture of HUD-Code manufactured housing and site-built homes side-by-side, essentially indistinguishable. The manufactured housing units are put on permanent concrete foundations, which allows them to be financed with conventional real estate mortgages. Manufactured housing saves 15 percent to 20 percent over conventional stick-built construction, and offers low-cost housing in a rural region that lacks skilled labor for housing construction. With site-built add-ons such as garages, decks, and porches, they appear as stick-built construction. The site-built units also feature garages and porches similar to the manufactured housing. HUD-Code housing has traditionally been placed on point or pier foundations on leased land. At High Meadows, permanent concrete foundations are used on land purchased by the homeowner. The 2 by 6 construction boosts energy performance, with R-22 walls and R-38 ceilings. There is a 5 percent down mortgage program, while a few of the homes qualify for 3 percent down mortgages under a special Rural Housing program.



PROJECT PROFILE

Housing Type

Single-family detached houses on a suburban site.

Technology and Design

HUD-Code manufactured homes interspersed with conventional stick-built construction. HUD-Code units are on permanent foundations and have site-built attachments such as garages, porches, and decks to blend the units into the development.

Project Size

158 units ranging from 1,100 to 1,650 square feet.

Housing Price

Units average \$104,000; 74 percent of reported median.

Financing

Low down-payment program; Rural Housing program assistance.

PROJECT CREDITS

High Meadows Development Co., LLC (*developer*), Craig White (*chief managing member*), Roderick Knoll (*managing member*); **American Homestar Corp.** (*principal product producer*); **Ken Cornella Construction** (*land development construction*); **Rocky Mountain Bank and Trust** (*land development financing*); **Ford Consumer Finance Corp.** (*construction financing*).



Additional Technology Information

Manufactured Housing Institute
2101 Wilson Blvd., Suite 610
Arlington, VA 22201-3062
703-558-0652 (phone); 703-558-0401 (fax)

Additional Project Information

High Meadows Development Co., LLC
13390 Harrison Street, Suite 120
Denver, CO 80241
303-457-1160 (phone); 303-457-4192 (fax)



Manufactured housing is set side-by-side conventional construction, with little if any distinction between them. Concrete foundations and site-built features such as garages are part of the HUD-Code package.



CANTERBURY COMMUNITIES

North Carolina

Canterbury Communities in North Carolina is comprised of four separate developments, all using manufactured housing. Together, Pinecroft in Youngsville, Lexington in Apex, Bridgegate in Wendel, and Fairview in Fuquay-Varina, respond to the growing housing need in the Raleigh-Durham region. The four developments will comprise more than 350 homes when completed. These suburban developments mark a departure of traditional manufactured communities, and signal the growing impact that HUD-Code has on new housing construction. The Canterbury Community houses are delivered to the site, where additions such as porches and garages are added to make these units look stick-built. Canterbury also combines units perpendicularly to each other to create wings. These HUD-Code houses are also built on permanent foundations, some faced with brick, which allows them to qualify as real estate, financed through conventional, lower-rate mortgages. Mortgage assistance includes a program to pay closing fees. With a suburban layout and durable, low-maintenance materials, Canterbury Communities offer affordable alternatives to site-built construction.

PROJECT PROFILE

Housing Type

Detached single-family houses on suburban lots.

Technology and Design

HUD-Code manufactured houses on masonry foundations, with such features as garages and porches site built. Some floor plan designs incorporate two or more modules, creating wings and entry courts.

Project Size

350 units on four development sites, averaging 1,650 square feet.

Housing Price

Units are offered for an average of \$90,000; 77 percent of reported median.

Financing

Developer pays the majority of buyers' closing costs; conventional mortgages.

PROJECT CREDITS

Canterbury Communities, Inc., a subsidiary of Pulte Home Corp., Mike Furlow (*president*), Ashton Young (*vice president of operations*), John Kunkel (*chief financial officer*), John Haynes (*director of land*), Patti Crane (*general sales manager*), Ed Suchora (*marketing manager*); **R-Anell Custom Homes, Inc.**, Dennis Jones (*president*), Darrel Mullinix (*sales manager*); **Gold Medal, Inc.**, Randy Hefner, (*sales manager*).



Manufactured housing units are set side-by-side or at perpendicular angles to create wings on these suburban houses. Permanent brick-faced foundations are used, along with porches and garages.



Additional Technology Information

Manufactured Housing Institute
2101 Wilson Blvd., Suite 610
Arlington, VA 22201-3062
703-558-0652 (phone); 703-558-0401 (fax)

Additional Project Information

Canterbury Communities
Pulte Home Corporation
555 Winderley Place, Suite 420
Maitland, FL 32751
407-875-1001 (phone); 407-875-2612 (fax)



3. ENERGY EFFICIENT

Design and construction of homes that are energy efficient has, for a number of years, been an intelligent approach to conserving fossil fuels and countering global warming. Home energy efficiency can be attained with a variety of strategies, such as increased insulation levels in roofs, floor, and walls to reduce the thermal impacts of hot and cold climates; better performing heating, ventilation, and airconditioning (HVAC) systems including furnaces, condensers, distribution, and controls; high-performance glazing with insulated glass, films, and coatings to reduce heat gain and heating/cooling loss; caulking, house-wrap, and other techniques to reduce air infiltration; and low-energy lighting fixtures and appliances to cut power consumption. In regard to housing affordability, energy efficiency is an important factor in reducing the operating costs of a house (which might make the difference between homeownership and foreclosure). There are also several programs offered by banks, utility companies, and public agencies around the country that provide reduced mortgage rates for houses that are good energy performers—another contribution to affordability. Energy efficiency can also enhance the comfort of a home.

Wood Glen	46
Green Valley	48
Claybrooke	50
Esperanza del Sol	52
Harambee Homes	54
Copiague	56
Lacy Laine	58

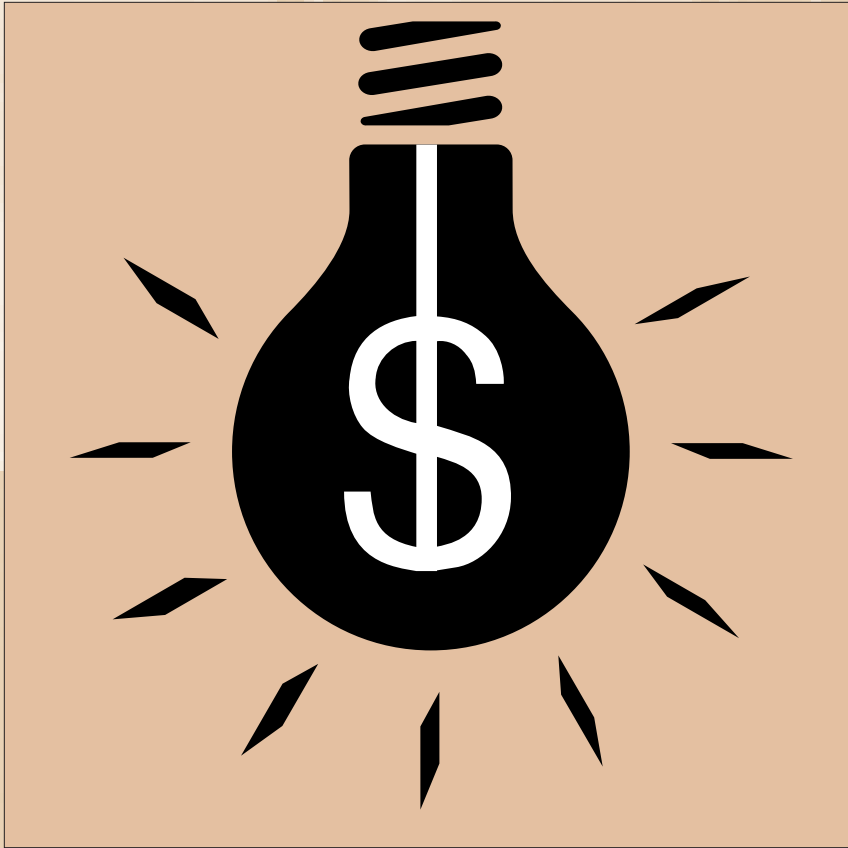

WOOD GLEN

Houston, Texas

In Houston's hot and humid climate it is not unusual for low-income families to pay utilities equal to more than 50 percent of their housing payments in older, inefficient homes. In response, Houston Habitat for Humanity is constructing homes in the Wood Glen subdivision designed to achieve a high level of energy and resource efficiency. Rated as 5-Star homes under EPA's Energy-Star Home Program, the three- and four-bedroom units are sited, shaded, and landscaped to minimize solar gain. They include high efficiency heating and cooling equipment, air infiltration controls, programmable thermostats, increased levels of insulation, improved HVAC duct design with mastic sealant, and energy-efficient lighting. Water-saving plumbing fixtures, resource-efficient building materials, and wood waste-minimization framing techniques further contribute to resource conservation. Buyers of Wood Glen homes should expect an annual savings of \$264 or 9 percent, compared to Houston Habitat homes without the energy-efficient features. The average annual income of Houston Habitat's potential homebuyers is \$14,000 for a family of five. Over 100 homes are planned for construction in 1998.



PROJECT PROFILE

Housing Type

Single-family detached houses on suburban sites.

Technology and Design

Units incorporate a number of energy-efficient features such as boosted insulation, improved HVAC design, extensive caulking, and passive solar design strategies.

Project Size

30 units ranging from 1,100 to 1,300 square feet.

Housing Price

Units average \$41,800; 36 percent of reported median.

Financing

Sweat equity through volunteer construction; no-interest loans for qualified low-income buyers.

PROJECT CREDITS

Houston Habitat for Humanity,
Reverend E. Michael Shirl;
Houston Lighting and Power Company;
Emerald Homes;
Alliance to Save Energy;
Florida Solar Energy Center;
National Association of Home Builders Standing Committee on Energy;
Texas State Energy Conservation Office;
U.S. Department of Energy;
U.S. Environmental Protection Agency.



Additional Technology and Project Information

Houston Habitat For Humanity
P.O. Box 8467
Houston, TX 77288
713-521-2816 (phone); 713-521-0251 (fax)

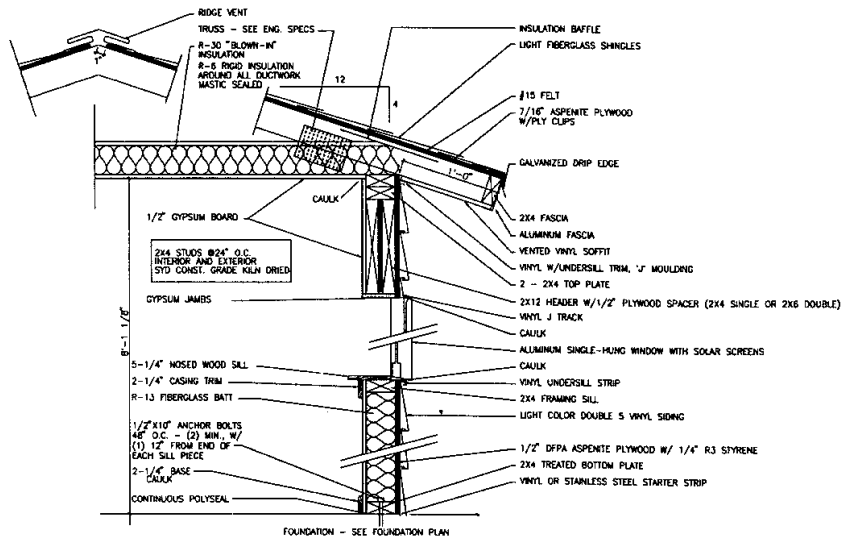

Drawing demonstrates some of the energy-conservation features in the Wood Glen Homes, which incorporate higher levels of insulation, tighter envelopes, and passive solar design strategies.



GREEN VALLEY ESTATES

Fort Payne, Alabama

Houses in the Green Valley Estates development feature energy efficient construction typically found in Northern states. The three-bedroom homes have wet-blown cellulose insulation to achieve R-14 walls and an R-45 ceiling. Extensive caulking and air sealing, verified by blower door testing, further decrease the heat from entering or exiting the home. Optimum value engineering, used to reduce the quantity of framing materials, also cuts energy consumption. The homes are heated and cooled with geothermal heat pumps which move heat between the ground and the building at efficiencies greater than conventional air-source heat pumps. A “desuperheater” extracts heat from the refrigerant of the heat pump and supplies half of the domestic hot water. This method decreases the use of costlier electric resistance water heating and further improves the efficiency of the heat pump. Hot water pipes running below the ground slab are fully insulated. Air distribution ducts are located in conditioned space, providing both increased energy efficiency and comfort to the occupants.



Green Valley homes feature generous caulking within the frame, cellulose insulation in the walls and ceilings, tighter envelopes, and geothermal heat pumps, all to achieve superior energy performance.

PROJECT PROFILE

Housing Type

Single-family detached houses in a suburban development.

Technology and Design

Units incorporate a number of energy-saving strategies such as increased insulation levels, exterior insulation, sealing, and geothermal heat pumps.

Project Size

37 units at 1,200 square feet.

Housing Price

Units are between \$60,000 and \$70,000; 56 percent to 66 percent of reported median.

Financing

Units qualify for Energy Efficient Mortgages; also FMHA and VA mortgage programs.

PROJECT CREDITS

Warren Builders, Inc. (*builder*)



Additional Technology and Project Information

Warren Builders
8532 U.S. Highway 431
Albertville, AL 35950
205-878-1847 (phone); 205-878-4139 (fax)



CLAYBROOKE

Baltimore, Maryland

Claybrooke is a subdivision in suburban Baltimore near the interstate, public transportation, and large employment bases. The homes are designed for energy-efficiency and resource conservation, exceeding state and local energy building codes by 45 percent. Stick-built with laid block foundations, the homes feature high-efficiency heating and air conditioning systems with all ducts in conditioned space, low-e glazing, and foam sealants. An outside agency tests each home to ensure its energy efficiency. Annual heating and cooling costs for an average Claybrooke home are estimated at \$580. For further resource conservation, Claybrooke homes include low-flow shower heads and use engineered wood products in trusses. Subcontractors remove their construction waste, an incentive to produce less waste. All homes are in the Baltimore Gas and Electric Energy/Wise New Home Program and qualify for “stretch” ratio financing. The builder offers further buyer-assistance through a sweat equity program, closing-cost help (via a six-month rental), and a rent-to-buy program (builder pays the difference between buyer’s former monthly rent and monthly mortgage payments for one-year).



PROJECT PROFILE

Housing Type

Townhouses and single-family detached houses in a suburban development.

Technology and Design

Units incorporate a number of energy-saving strategies such as increased low-e glazing, energy-efficient light fixtures, foam sealants, high efficiency HVAC.

Project Size

99 units; 73 townhouses at 1,740 square feet; 26 detached units ranging from 1,300 to 1,900 square feet.

Housing Price

Units average between \$102,000 and \$140,000; 56% to 66% of reported median.

Financing

Purchasing and closing cost assistance; local utility new home program; builder offers “sweat equity” and “rent-to-buy” programs.

PROJECT CREDITS

Bob Ward Homes Group (*builder*).



Additional Technology and Project Information

Bob Ward New Homes Group
2700 Philadelphia Road
Edgewood, MD 21040
410-679-5000 (phone); 410-679-4107 (fax)

Among the energy-conservation features in the Claybrooke homes are tighter envelopes, efficient HVAC systems, and low-e windows. Homes were tested with blower-doors to determine efficiency.



ESPERANZA DEL SOL

Dallas, Texas

Esperanza del Sol (hope of the sun) is an on-going project of nine energy-efficient, single-family detached homes on an infill site in downtown Dallas. The two-story, three-bedroom homes face each other across a green courtyard, with driveways, parking, and road on the opposite side. Geothermal heat pumps provide quality heating and cooling for a builder-guaranteed cost of less than \$1 per day, and free hot water for about eight months. Reduced flow plumbing fixtures save on water costs. The homes use 2 x 6-inch, 24-inch on-center optimal value engineered (OVE) framing with 6 inches of cellulose insulation. Extensive caulking, sealing, and gasketing provide maximum air tightness. Floor trusses serve as a plenum for air distribution. Mechanical ventilation controls air pressure differences throughout the year.

Passive solar exposure is maximized through house and window placement, thermal mass flooring under south-facing windows, and light stucco exteriors. Esperanza del Sol homes are eligible for Energy Efficient Mortgages; families earning as little as \$24,000/year can qualify.

PROJECT PROFILE

Housing Type

Single-family detached houses on urban infill sites.

Technology and Design

Units incorporate a number of energy-efficient features such as boosted insulation, geothermal heat pumps, extensive caulking, and passive solar design strategies.

Project Size

9 units at 1,273 square feet.

Housing Price

Units are offered at \$79,950; 65 percent of reported median.

Financing

Eligible for Energy Efficient Mortgage program; assistance from the Dallas Affordable Housing Partnership financing program.

PROJECT CREDITS

BBH Enterprises, Inc., Barbara Harwood (*president*);
TU Electric;
Edison Electric Institute.



Additional Technology and Project Information

BBH Enterprises, Inc.
2718 Wagonwheel Drive
Carrollton, TX 75006
214-358-0001 (phone); 972-418-7773 (fax)



Energy-saving design elements of the Esperanza del Sol homes include blown-in cellulose insulation, concrete floors for thermal mass, geothermal heat pumps, and tighter envelopes.



HARAMBEE HOMES

Chicago, Illinois

“Harambee” in Zwahili means “Let’s get together and push,” which is the essence of this effort to house seven African American families in inner-city Chicago. The Harambee Homes Program assists low-income families to plan and build their own homes with technical guidance by Perry Bigelow, founder of the program and oversight by local church groups. Each family provides sweat equity, and has committed to assisting each other in construction until the entire enterprise is completed. The clustered units are built on land donated by the city (the city also granted waivers for all permitting and fees). Owner-building and the city’s largess brings the housing cost down to about \$60,000 per unit (primarily for materials). The homes incorporate a number of material-saving features such as 2x6 framing on 24-inch centers, two-stud corners, and single top plates. Shallow, frost-protected foundations reduce site excavation costs. The homes are super-insulated with R-25 walls and R-38 floors, and double-glazed low-emissivity windows. The tight, insulated construction allows



PROJECT PROFILE

Housing Type

Clustered, single-family attached houses on an inner-city site.

Technology and Design

Units incorporate a number of energy-efficient features such as boosted insulation, extensive caulking, insulated shallow foundations, and are designed as co-housing, to allow families to share communal living and dining spaces.

Project Size

8 units averaging 1,200 square feet.

Housing Price

Units average \$30,000; 16 percent of reported median.

Financing

Sweat equity by owner-builders; public and non-profit assistance with subsidies and donated land.

PROJECT CREDITS

Harambee Homes (*developer*),
Perry Bigelow (*president*);
Isaiah Community Development Group;
Lawndale Christian Development Corp.;
City of Chicago;
The Chrysalis Foundation of the Home Builders Association of Greater Chicago, William Maybrook, Neal Hunter.



Additional Technology and Project Information

Harambee Homes
3555 W. Ogden Avenue
Chicago, IL 60623
847-705-6400 (phone); 847-705-6733 (fax)

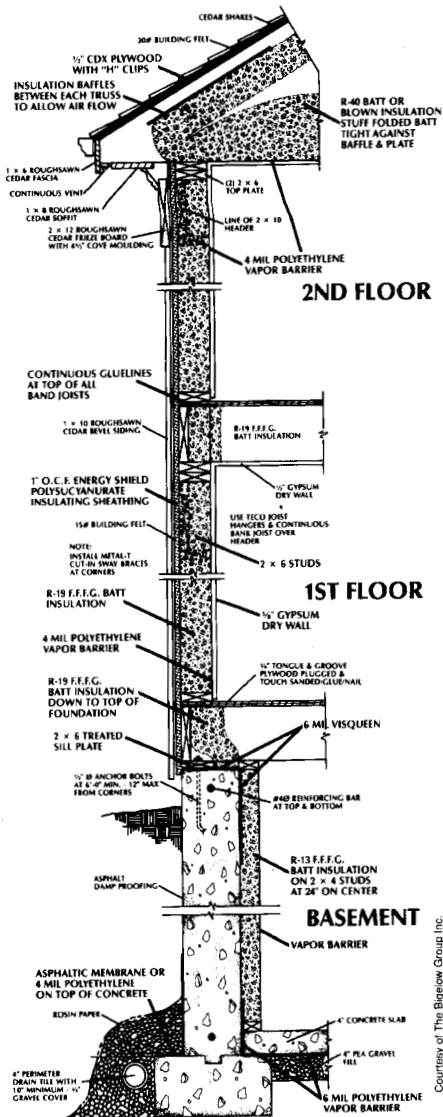

Harambee Homes are built according to drawings that result in increased energy efficiency due to better insulation and features such as insulated windows. The site-built homes offer a warranty against annual heating bills exceeding \$200.

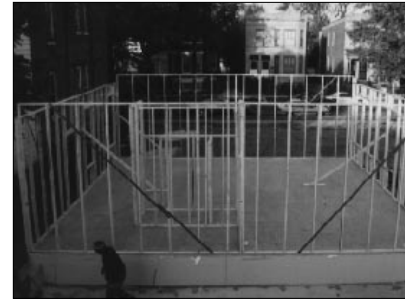

Courtesy of The Bigelow Group, Inc.

COPIAGUE

Long Island, New York

Copiague is a small development of entry-level, below median-price homes on Long Island within a one-hour commute to Manhattan. Built with an emphasis on energy-efficiency, the Copiague homes typically receive energy bills one-half those of similar homes in the area. The homes are sited to maximize southern exposure. Walls are designed with 2 x 6-inch studs placed 24-inches on-center, the optimal value engineering (OVE) framing method that both saves lumber and leaves maximum space for insulation. The addition of rigid insulation board provides an R-25 wall and reduced sidewall sheathing costs. Extra attic insulation yields an R-38 roof. A gas boiler controlled by a set-back thermostat supplies air heating at over 87 percent efficiency (AFUE) and domestic hot water at 84 percent minimum efficiency. The single mechanical exhaust system operates at variable speeds to continuously control humidity and air quality. Copiague homes are certified New York Star Homes, exceeding the state's energy conservation standards by at least 25 percent. They qualify for Energy Efficient Mortgage programs recognized by Fannie-Mae and FHA with as little as 2 percent down payment.



PROJECT PROFILE

Housing Type

Single-family houses on suburban lots.

Technology and Design

Houses constructed with a variety of energy-saving features such as passive solar design, increased insulation, sealing of the building envelope, highly efficient mechanical systems.

Project Size

Five units at 1,204 square feet.

Housing Price

Units are offered for an average of \$125,800; 65 percent of reported median.

Financing

Financing packages available with low down payments; homes qualify for Energy Efficient Mortgage program.

PROJECT CREDITS

New Age Builders (*builder/developer*), William B. Siegel (*president*);
Long Island Lighting Company (*rebate for energy efficiency*);
Town of Babylon, New York.



Additional Technology and Project Information

New Age Builders, Inc.
186 West Montauk Highway, Suite D-11
Hampton Bays, NY 11946
516-728-6644 (phone); 516-728-0728 (fax)



Energy-saving strategies at Copiague include better caulking in the wood frame, greater amounts of insulation, and tighter envelopes, resulting in homes that exceed state energy-conservation requirements.



LACY LAINE

Wasilla, Alaska

Lacy Laine is a small subdivision in the Mat-Su Valley near Anchorage. These three-bedroom, one-bath homes are super energy-efficient and meet the EPA's 5-Star+ Energy Rated Standard. Each air-tight home includes a heat recovery ventilation system, a 92 percent sealed combustion gas forced air furnace, R-21 wall insulation, R-40 ceiling insulation, and low-e argon-filled glazing with vinyl frames. Humidity and mold problems unique to Alaska are virtually eliminated through use of high filtration ventilation systems. The 5-Star+ energy rating features produce not only a more comfortable living environment with better air quality, but also reduce monthly energy costs for homeowners. Lacy Laine prices start at \$77,000, well below area median. Most of the homes include a one-car, completely finished, attached garage. Financing is available through the Rural Housing Service funding program, with zero down-payment and interest rate subsidies to qualified buyers (families with under \$19,000 annual income).



PROJECT PROFILE

Housing Type

Single-family detached houses on suburban sites.

Technology and Design

Units incorporate a number of energy-efficient features such as boosted insulation, extensive caulking, heat recovery ventilation system, air filtration system.

Project Size

3 units at 1,008 square feet.

Housing Price

Units average \$85,500; 56 percent of reported median.

Financing

Zero down-payment and low-interest mortgages available to low-income buyers.

PROJECT CREDITS

Hall Quality Homes, Jess Hall (president);

U.S. Rural Economic and Community Development Program.



Additional Technology and Project Information

Hall Quality Homes
P.O. Box 1987
Palmer, AK 99645
907-746-2757 (phone); 907-746-2759 (fax)

Lacy Laine homes offer better energy performance and affordability without sacrificing such amenities such as attached garages, porches, and complete finishes inside and out.



4. PANELIZED CONSTRUCTION

Panelized houses are made up of a series of prefabricated two-dimensional components, such as walls, floors, roof panels, and interior partitions, which are finished in the factory and connected on site. The panelized components vary in terms of size and the degree of finish. Most panelized home manufacturers, such as Miles Homes International, offer complete home packages including not only the panelized components, but windows, doors, kitchens, bathrooms, etc. Often with panelized construction the bathroom and kitchen are factory assembled as “wet cores” around which the panelized house is assembled. This allows the plumbing work on site to be minimized. Panelized construction permits a greater variety in terms of housing design (as compared to manufactured housing, for example) because the components are not restrained within the limits of a modular “box.” The components are also easier to ship over roadways. The advantages of panelized construction are better quality control over the components because they are assembled in a factory, more efficient use of materials with less waste through assembly line production, faster erection time on site, lower material costs, and lower skill level required for construction workers (which may result in lower labor costs).

Dearbought62
Twin Cities Habitat66
McChesney Homes68
Native American Initiative70

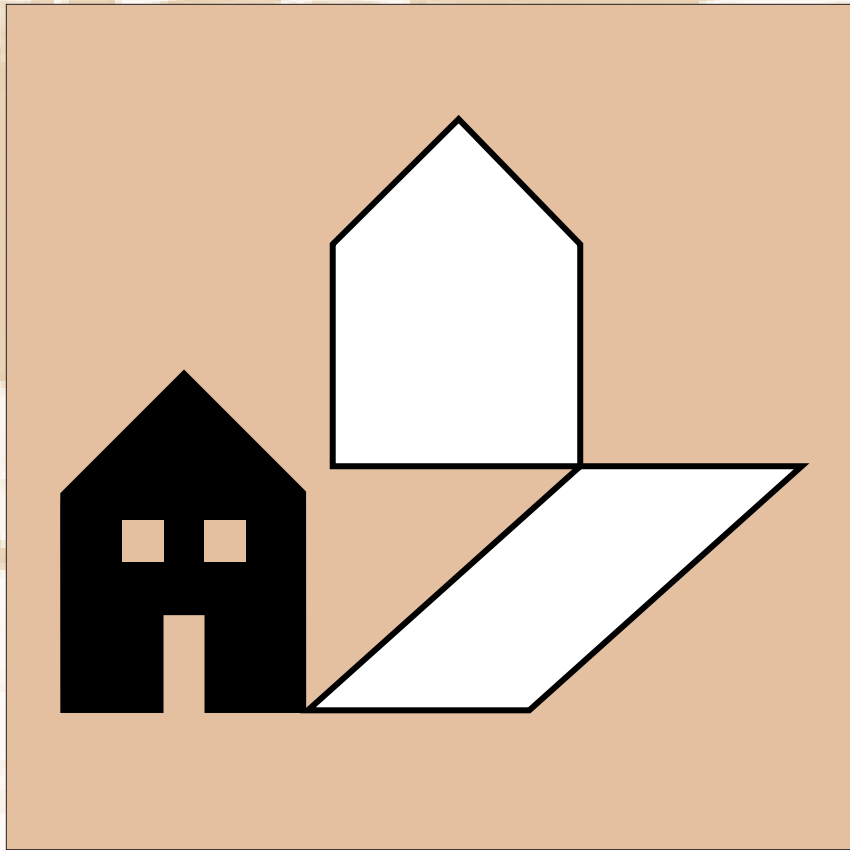

DEARBUGHT

Frederick, Maryland

Dearbought is a 600-unit development now being built in historic Frederick, Maryland, a suburb of Washington, D.C. The community is planned with “New Urbanism” principles of small-scale streets and open green spaces. Ryan Homes is part of the Dearbought community, with 48 townhouses and 58 single-family houses competing with other national builders such as Pulte and Regency. The Ryan homes look conventional, but their construction is highly automated. The units employ panelized walls and trusses made in Ryan’s Thurmont, Maryland, plant with a high degree of waste reduction and quality control. On the site, first and second floor platforms are constructed and the roofs are assembled. A crane then raises the second floor platform and the first floor walls are quickly set in place. The second floor is placed and then the second floor panelized walls are raised. The roofs are then lifted into place and secured. This technique greatly telescopes construction time and allows the units to be under roof quickly.



PROJECT PROFILE

Housing Type

Townhouse and single-family detached units in a suburban development.

Technology and Design

Units comprised of prefabricated panels and roof assemblies, delivered to the site. Floors are framed on site, roofs are lifted by crane, preassembled walls are raised, and roofs are lowered and secured.

Project Size

106 units, ranging from 1,237 to 1,288 square feet.

Housing Price

Units range from \$110,000 to \$115,000; 60 percent to 63 percent of reported median.

Financing

Conventional mortgages; builder offers financing program.

PROJECT CREDITS

Ryan Homes, (*builder*);
Natelli Communities, (*developer*).



Additional Technology and Project Information

NVR, Inc.
555 Quince Orchard Road, Suite 300
Gaithersburg, MD 20878



Conventional appearing units are constructed of panelized elements that are lifted into place by crane, positioned, and secured, all within the span of a few hours.





Ryan Homes' Dearbought development includes preassembled truss roofs that are lifted off so that walls panels can be put into place. Roofs are then moved into position and secured.



TWIN CITIES HABITAT FOR HUMANITY

Minneapolis and St. Paul, Minnesota

The 14 homes built on scattered infill sites throughout the Twin Cities metropolitan area are from a plan book developed by Miles Homes for use by nonprofit builders and community development centers such as Habitat for Humanity. The *64 Super Affordable Building Material Packages & Home Plans* book contains a wide variety of designs, styles, and sizes. Two of the houses constructed were designed for people with physical disabilities. All 14 homes were constructed for under \$40,000 on land that was distressed property. Miles developed the plan book for use specifically by nonprofit organizations, which could benefit from Miles' precut and panelized home packages, delivered to the site complete for erection. Miles' management of the materials packages up until the time of construction is a boon for nonprofits that must run projects on shoestring budgets and with small staffs. Miles Homes offers this plan book program to nonprofits around the country, meeting their particular needs in providing affordable housing.



PROJECT PROFILE

Housing Type

Scattered site, infill, detached single-family

Technology and Design

Preframed component homes with panelized walls, for houses with compact, efficient plans.

Project Size

14 units, ranging from 1,008 to 1,422 square feet.

Housing Price

Units are under \$40,000, on distressed property; 38 percent of reported median.

Financing

A combination of sweat equity from prospective homeowners, donated labor from Habitat for Humanity volunteers, and discounts on materials from Miles Homes.

PROJECT CREDITS

Miles Homes International, Inc.,

Kim Flesner (*Habitat program coordinator*), Herbert Getzler (*executive advisor*);

Twin Cities Habitat for Humanity, Stephen Seidel (*executive director*);

Homestyles Publishing and Marketing, Jeff Heegaard (*president*), Pamela Robertson (*editorial*);

Habitat for Humanity International, Inc., Peter Dalva (*architect*),

Jane Emerson (*corporate relations*), Frank Purvis (*environmental director*).

Lifestyles Design Services, Mark Englund (*managing partner and illustrator*); Perry Bolin, (*architect*);

Danner Press, Mike Kohlrusch (*illustrator*);

The Philip Stephen Companies, Inc.;

Richard Scales Advertising, Rick Thompson (*architect*), Margaret Griffith (*environmental designer*).

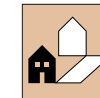

Additional Technology and Project Information

Miles Homes International, Inc.

5155 East River Road

Suite 402

Minneapolis, MN 55421

800-905-4224 (phone); 612-586-6379 (fax)



Panelized homes of a variety of sizes and styles are offered to nonprofit groups through a plan book. On site, construction time is compressed as elements are unloaded from a truck and assembled. Finished homes appear as conventional construction.



McCHESNEY TOWNHOMES

Orange, New Jersey

These five two-story attached homes for first-time buyers are an excellent example of technological innovation with some creative financing on a neighborhood scale. Developed and constructed by a local nonprofit, HANDS, Inc., McChesney Townhomes are built in an urban neighborhood on land partially donated by the city, which also waived sewer tap fees. Panelized wall construction was used to accelerate the building process. HANDS set up a panelization factory in the neighborhood, financed by the nonprofit New Jersey Community Loan Fund. This low-capital operation provided jobs for unskilled and semi-skilled workers from the neighborhood as well as panelized components for the houses. Where possible, products produced by local companies and businesses were used in the units. All buyers received counseling through the New Jersey Citizen Action Loan Counseling Service. A mortgage program of 5 percent down and low interest rates with no points or PMI was made available. Federal HOME funds were available through the New Jersey Department of Community Affairs.



PROJECT PROFILE

Housing Type

Single-family attached homes on an urban infill site.

Technology and Design

Preframed component homes with panelized walls manufactured in a neighborhood factory; emphasis on locally manufactured or available materials and equipment.

Project Size

5 units at 1,152 square feet.

Housing Price

Units offered for \$61,000; 90 percent of reported median.

Financing

Nonprofit provided financial assistance in setting up panelization factory; HOME funds allowed low down-payment mortgages; city donated land; permit fees waived.

PROJECT CREDITS

HANDS, Inc. (*developer and general contractor*), Patrick Morrissy (*executive director*);

New Jersey Community Loan Fund, Anne Li, (*director of staff*);

New Jersey Citizen Action Counseling Service, Phyllis Salowe-Kaye, (*director of staff*);

First Fidelity Urban Investment Corp., Carmine D'Alessio (*loan officer*);

National Housing Institute, Harold Simon;

St. Matthews A.M.E., Rev. Reginald T. Jackson;

Fund for New Jersey, Mark Murphy;

New Jersey Department of Community Affairs, Peggy Huchet;

Mostoller Travisano Architects, the late Fred Travisano (*architect*);

City of Orange, the late Patricia Juliano (*councilwoman*).

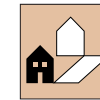

Additional Technology Information

Panelized Building Systems Council
Building Systems Councils
National Association of Home Builders
1210 15th Street, NW
Washington, DC 20005
800-368-5242, ext. 576 (phone);
202-861-2141 (fax)

Additional Project Information

HANDS, Inc.
439 Main Street
Orange, NJ 07050
201-678-3110 (phone); 201-678-0014 (fax)

Panelization factory was set up in the neighborhood to assemble elements for McChesney Townhomes, employing local residents. Finished homes have a density appropriate to this urban neighborhood.



NATIVE AMERICAN INITIATIVE

Various sites around the U.S.

The Native American Initiative is just one of a number of programs established by Miles Homes to serve the affordable housing market. This housing manufacturer developed a program to work with tribal governments to provide first-time homeownership opportunities on tribal land. So far, 170 homes have been built in Minnesota and Michigan, and another 100 homes in six other tribal projects from New York to Montana. Miles manufactures panelized and pre-cut house packages that include name-brand fixtures and equipment. Miles uses its large-scale operation to get the best price on materials bought in bulk and passes the savings on to the homebuyer. Additional standardization of materials and products results in up to 10 percent additional savings on some items such as cabinets, windows, and floor covering. This savings is donated to the tribes in the form of additional building packages. The panelized and pre-cut house packages are delivered on-site by Miles, which assists the tribal governments in managing the projects. The preframed components also present the opportunity for construction job creation on the reservation, where low and semi-skilled workers can begin to learn a trade.



PROJECT PROFILE

Housing Type

Scattered site, detached single-family.

Technology and Design

Preframed component homes with panelized walls, for houses with compact, efficient plans. The plans and materials packages are part of a special series of homes that Miles created to be used by nonprofits around the United States.

Project Size

270 units, ranging from 1,000 to 1,500 square feet.

Housing Price

Units range from \$75,000 to \$100,000 on tribal lands.

Financing

A combination of sweat equity from prospective homeowners, and discounts on materials from Miles Homes.

PROJECT CREDITS

Miles Homes International, Inc.,

Community Based Housing Division, Philip S. Dommer, (*director*), William A. Keim (*regional representative*), Terry Taylor (*purchasing manager*);

Mille Lacs Band of Ojibwe Indians,

Marge Anderson (*chief executive of the Mille Lacs Band*), Raymond Kegg (*executive director of Housing Authority*), Eugene Bahr (*construction specialist*);

Sault Saint Marie Tribe of

Chippewa Indians, George Nolan (*Housing Commission chairperson and Tribal vice-Chair*), Jolene Nertoli (*Housing Division director*), Russ McKerchie (*construction manager*), Bruce LaPointe (*assistant construction and project manager*);

Earthstar Project, Inc., Perry Bolin (*consultant*);

The Philip Stephen Companies, Inc. (*consultant*).



Additional Technology and Project Information

Miles Homes International, Inc.
5155 East River Road
Suite 402
Minneapolis, MN 55421
800-905-4224 (phone); 612-586-6379 (fax)

Panelization



Panelization rationalizes the house's elements into easily assembled pieces that can be shipped anywhere. Panels are constructed in small factories that can provide local employment and skill-building.

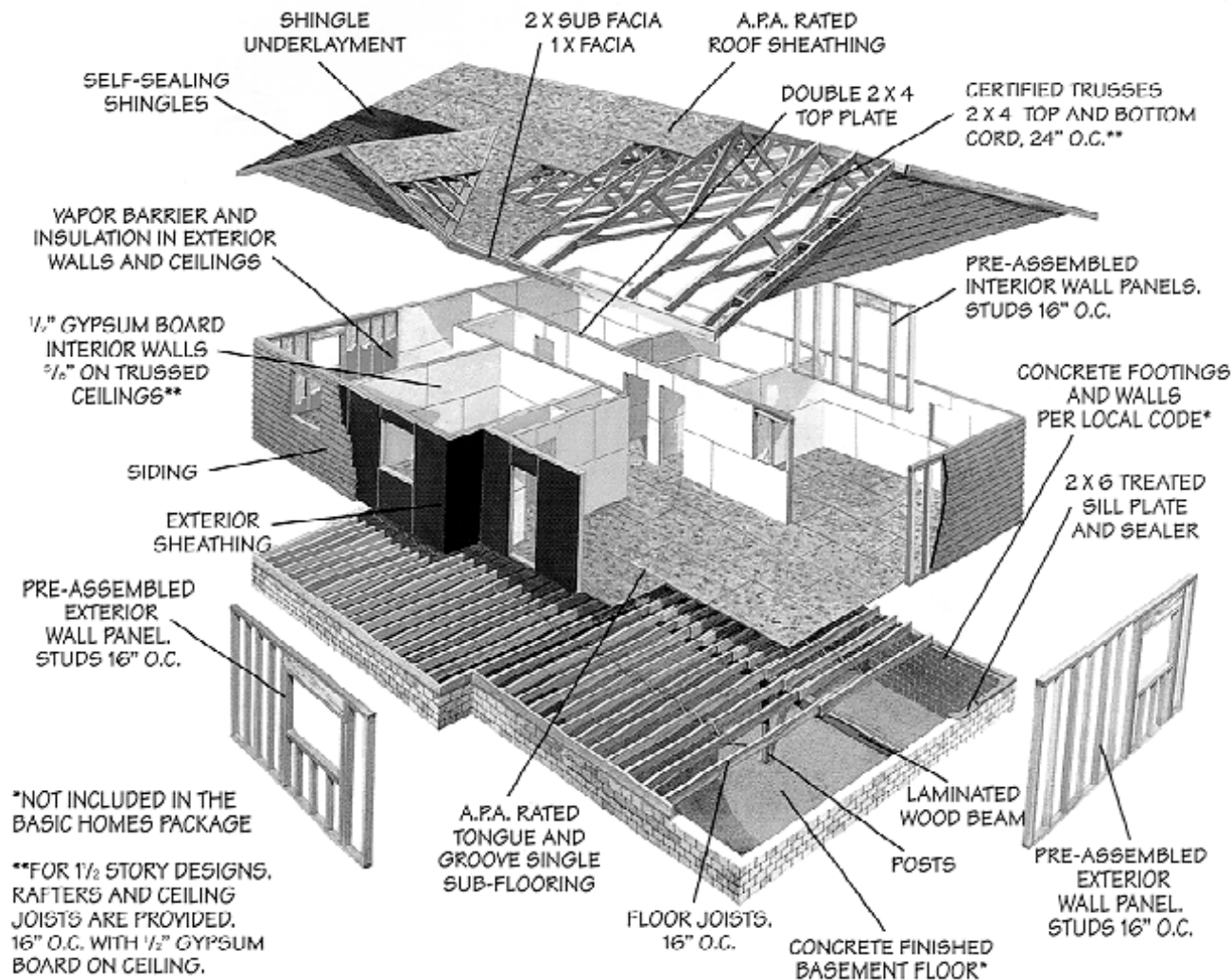



Panelized homes constructed on Native American reservations by local labor are in stark contrast to existing housing. Several hundred homes have been built on reservations using Miles Homes packages.



5. STRUCTURAL INSULATED PANELS

Structural insulated panel (SIP) construction continues to gain a greater market share of the homebuilding market as its ease of use and energy performance becomes better known. SIPs are composed of two exterior skins (such as oriented strand board, waferboard, plywood, or gypsum board) adhered to a rigid plastic foam core (usually expanded polystyrene). Panels are available in a variety of thicknesses depending on application requirements, from 2” to 12”, and in sizes from the standard 4x8 feet to 8x24 feet. Their primary application is on the exterior walls and roof of a house, with conventional wood or steel stud framing for interior partitions. Because SIPs have a solid core of insulating material, their use can result in better energy performance than conventional wood-stud construction. While the cost of a SIP house may be more for materials, the shortened construction period and the superior energy performance contribute to cost savings both in the short and long term. SIPs can be adapted to virtually any house design, and are also available as part of predesigned kit homes.

South Tucson Development76
Hillside Oaks78
FBC Rent-to-Own80
City Life82
Chimney Rock84
Crown Hills86

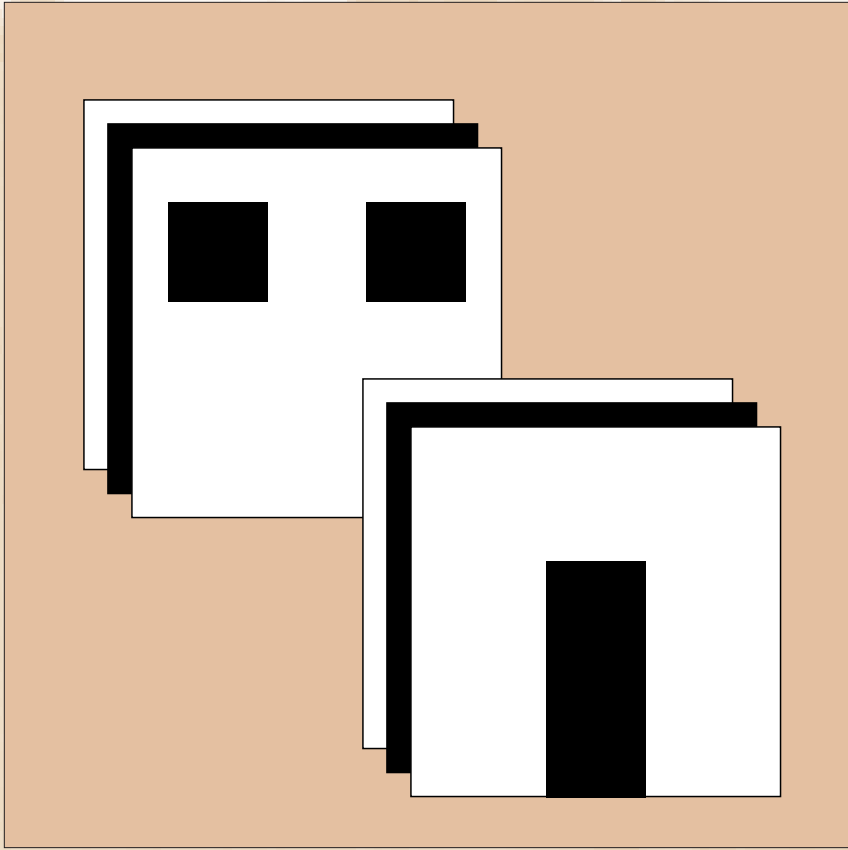

SOUTH TUCSON DEVELOPMENT

South Tucson, Arizona

This project combines innovative building technology and a program to help the unemployed build job skills. The houses are constructed of structural insulated panels (SIPs) made by a local company. The panels arrive on-site precut and punched with window openings, ready to assemble, cutting erection time over conventional construction by two-thirds. The SIPs offer exceptional insulative qualities, with R-27 walls, and R-42 ceilings, thus contributing to significant energy savings. The units also have double-pane windows, energy efficient gas furnaces with fresh air recovery systems, and a number of passive solar design features, resulting in a 50 percent savings in energy use. The local utility awarded the houses a “Good Cents” designation. The city and state supplied funds for buying distressed lots for development, and the Federal Home Loan Bank provided Affordable Housing funds for downpayment assistance. Pima County provided HOME funds. The nonprofit builder and developer, Primavera, runs a builder education program that hires and trains low-income, homeless, unskilled, and at-risk youth to learn building skills and thus helps them to become more marketable for employment.



PROJECT PROFILE

Housing Type

Single-family units on scattered urban infill sites.

Technology and Design

Houses constructed of structural insulated panels (SIPs) which increases energy efficiency and reduces erection time. Highly efficient mechanical systems and passive solar design strategies to cut energy use and enhance comfort.

Project Size

Up to nine units, averaging 1,150 square feet.

Housing Price

Units offered for \$67,500; 49 percent of reported median.

Financing

A variety of federal, state, and local programs for downpayment and mortgage assistance.

PROJECT CREDITS

Primavera Builders, Inc., Jeanne V. Shaw (*administrator*);

Arizona Bank, David Wright (*chief executive officer*);

Federal Home Loan Bank of San Francisco, Gary L. Curley (*senior vice president*);

KC Panels, Ken Walston, (*president*);

Tucson Electric Power Co., Bekki Booth (*residential marketing coordinator*);

The Ochoa/Mission View Coalition, Leo Chavarria (*president*);

City of South Tucson, Shirley Villegas (*mayor*);

Pima County Community Services Department;

State of Arizona Department of Commerce, (*Infrastructure and Housing Development*), Steve Capobres

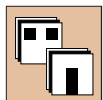

Additional Technology Information

Structural Insulated Panel Association
1511 K Street, NW, Suite 600
Washington, DC 20005
202-347-7800 (phone)

Additional Project Information

Primavera Builders
3690 South Park Avenue, Suite 801
Tucson, AZ 85713
520-882-5383 (phone); 520-882-5479 (fax)



Houses are assembled by at-risk and unemployed local youth, building skills while using SIP construction. Panels can be moved by hand as well as by crane, and are used for walls and roofs.

HILLSIDE OAKS

Dallas, Texas

A development in suburban Dallas, Hillside Oaks is innovative in its use of highly energy-efficient building technology and cost-saving mechanical systems. The houses are offered for \$72,000, which is a little more than half of the median price for new housing construction in the Dallas area. The homes are constructed of structural insulated panels (SIPs) which increases their insulative qualities and reduces erection time by at least half compared to site-built construction. Combined with the highly efficient building envelopes, these homes will be heated and cooled with geothermal pumps that use the steady temperature of the ground to transfer excess heat and cold. Geothermal heat pumps can be run more efficiently and for lower cost than conventional heaters and air-conditioning. Because of their energy-saving features, which make them 30% more efficient than code-compliant houses, these homes qualify for an Energy Star designation. The City of Dallas and the Enterprise Foundation offer down payment assistance funds for this development, and the city is working with local lenders to provide homebuyers with low-cost mortgages.



PROJECT PROFILE

Housing Type

Single-family homes on suburban sites.

Technology and Design

Houses constructed of structural insulated panels (SIPs) which are used for exterior walls and roofs. Heating and cooling provided by geothermal heat pumps to further reduce energy consumption.

Project Size

184 units, averaging 1,400 square feet.

Housing Price

Units are offered for an average of \$72,000; 59 percent of reported median.

Financing

Down payment assistance provided by the City of Dallas and the Enterprise Foundation; city also working with lending institutions to provide mortgages.

PROJECT CREDITS

Energy Wise Energy Management

Systems (*SIPs manufacturer and geothermal heat pump distributor*);
Carl Franklin Homes, Inc.;
JFP Contracting Services;
Bluebonnet Federal Savings Bank,
Bluebonnet Home Mortgage Company (*financing*);
Payless Cashways (*materials*).

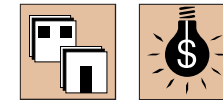

Additional Technology Information

Structural Insulated Panel Association
1511 K Street, NW, Suite 600
Washington, DC 20005
202-347-7800

Additional Project Information

Energy Wise Energy Management
Systems, Inc.
8238 Lovett
Dallas, TX 75227
214-275-4550 (phone); 214-275-4953 (fax)



SIP construction, where panels (some of which are precut for doors and windows) are delivered to the site and assembled, results in better energy performance. Hillside Oaks also uses geothermal technology for heating.



FBC RENT-TO-OWN

Louisville, Kentucky

FBC is building 20 houses and plans to construct 50 a year on scattered sites around Louisville's inner city. The homes are available for \$60,000 to \$62,000 and are constructed of structural insulated panels (SIPs) which cuts erection time by approximately 50 percent and boosts energy performance. The panels are made by FischerSIPs, Inc., with FBC as developer. The city has assisted the developer in assembling the sites. The Rent-to-Own program is available to prospective buyers who need time to get their credit history in order. Under the program, would-be homeowners can rent the unit for one year, with a portion of their rent going toward a downpayment on the house. Along with the Rent-to-Own option, a local real estate company is offering credit counseling to help families to budget their income and maintain their units. The county government has also made a homeownership counseling program available to this development.



PROJECT PROFILE

Housing Type

Single-family units on scattered urban infill sites.

Technology and Design

Houses constructed of structural insulated panels (SIPs) which increases energy efficiency and also reduces erection time.

Project Size

Initial project of 20 units of 1,152 square feet, with 50 units a year planned.

Housing price

Units offered from \$60,000 to \$62,000; 39 percent to 41 percent of reported median.

Financing

Rent-to-Own program helps prospective owners with downpayment; credit and homeownership counseling programs.

PROJECT CREDITS

FBC, Inc., Fred Fischer (*president*), J. Scott Brian (*vice president*), Steve Powell (*construction manager*);
David Fleischaker, Realtor;
Great Financial Bank, Bob Horton (*senior vice president*);
ID Designs, Igor Didkovsky, (*designer*);
City of Louisville HUD, Robert Brown, (*administrator*);
City of Louisville, Jim Allen, (*director of HUD*).

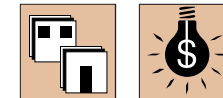

Additional Technology Information

Structural Insulated Panel Association
1511 K Street, NW, Suite 600
Washington, DC 20005
202-347-7800 (phone)

Additional Project Information

FBC, Inc.
1843 Northwestern Parkway
Louisville, KY 40203
502-778-5577 (phone); 502-778-5587 (fax)



FBC Rent-to-Own houses are a variety of styles, and are constructed in derelict neighborhoods on infill sites. SIP envelopes are then covered with exterior finishes, and amenities such as porches are added.



CITY LIFE

Portland, Oregon

City Life is an 18-unit, medium-density, mixed-income, infill homeownership development constructed on a 40,000 square-foot vacant lot close to public transit, jobs, schools, and shopping. Three housing types are included to encourage diversity: one duplex (two units), six rowhouse units, and ten courtyard homes. The duplex units were built to the Earth Smart standard that requires a higher level of energy efficiency and use of earth friendly and recycled products. Structural insulated panels (SIPs) were used for the exterior walls of the duplex to achieve higher R-values. The remaining sixteen homes were stick-built. Half the units are subsidized for low-income and are undistinguishable from the others and mixed throughout the development. Almost half the site is open space with auto access and parking at the rear, water run-off is retained on site. All City Life homes are insulated and energy efficient, built to the Oregon Super Good Cents standard of Portland General Electric. Construction waste was recycled as feasible.



PROJECT PROFILE

Housing Type

Single-family attached and detached homes on an urban infill site.

Technology and Design

Structural insulated panel construction of duplex unit; energy-efficient design and construction strategies on all units.

Project Size

18 units ranging from 950 to 1,250 square feet.

Housing Price

Units range from \$99,000 to \$124,950; 72 percent to 91 percent of reported median.

Financing

Nonprofit raised grant funds from private foundations to subsidize construction; energy rebates from utility company; local government subsidy of \$10,000 for predevelopment costs.

PROJECT CREDITS

REACH Community Development, Inc., Dee Walsh (*executive director*); **American Institute of Architects-Portland Chapter** (*design competition*); **Portland Metropolitan Home Builders Association**; **City of Portland**; **Oregon Housing and Community Services Department**; **Livable Oregon** (*chaired steering committee*); **Portland General Electric**; **BOORA Architects**, James Kalvelage, in association with Gregory Acker (*duplex design*); **BOORA Architects**, Ellen Fortin and Michael Tingley, in association with Robertson, Merryman, Barnes Architects (*courtyard homes design*); **Roderick Ashley Architect** (*row-house design*).



Additional Technology Information

Structural Insulated Panel Association
1511 K Street, NW, Suite 600
Washington, DC 20005
202-347-7800

Additional Project Information

REACH Community Development, Inc.
1135 SE Salmon Street
Portland, OR 97214
503-231-0682 (phone); 503-236-3429 (fax)



The City Life project displays different construction techniques. Duplex unit is of SIP technology, with townhouse and courtyard units are of conventional site-built construction. All are energy efficient.



CHIMNEY ROCK ESTATES

Weatherford, Texas

This development contains 43 homes on a suburban layout, with easy access to Dallas and Ft. Worth. The homes are being offered for an average of \$79,500, significantly below the \$121,000 median new home price for the area. This is being accomplished with no subsidy or public funding. The homes are constructed of structural insulated panels (SIPs) with expanded polystyrene cores for all exterior walls and the roof, with infill partitions of steel framing. This combination of technologies is mutually supportive: SIPs provide added insulation where it is most needed—in the building envelope—while the economy and quality of steel studs are exploited for interior partitions where thermal performance is not an issue. This combination of technologies results in a house that will reduce operating costs related to energy by 40 percent to 50 percent. SIPs can be precut and sent to the site for quick erection. They also help to deaden noise from exterior sources and add to the wall’s fire resistance. Brick exteriors provide durable materials for low maintenance costs.



PROJECT PROFILE

Housing Type

Single-family houses on suburban lots.

Technology and Design

Structural insulated panels for envelope, with steel-stud framing for interior partitions.

Project Size

43 units averaging 1,350 square feet.

Housing Price

Units average \$79,500; 65 percent of reported median.

Financing

Conventional mortgages; candidates for Energy Efficient Mortgage program.

PROJECT CREDITS

Weatherford Commercial Builders,
Wayne Bryant (*builder*).

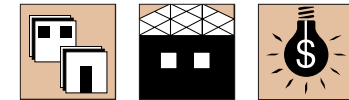

Additional Technology Information

Structural Insulated Panel Association
1511 K Street, NW, Suite 600
Washington, DC 20005
202-347-7800

Additional Project Information

Weatherford Commercial Builders
1810 Banks Drive
Weatherford, TX 76087
817-596-3954 (phone); 817-594-2004 (fax)

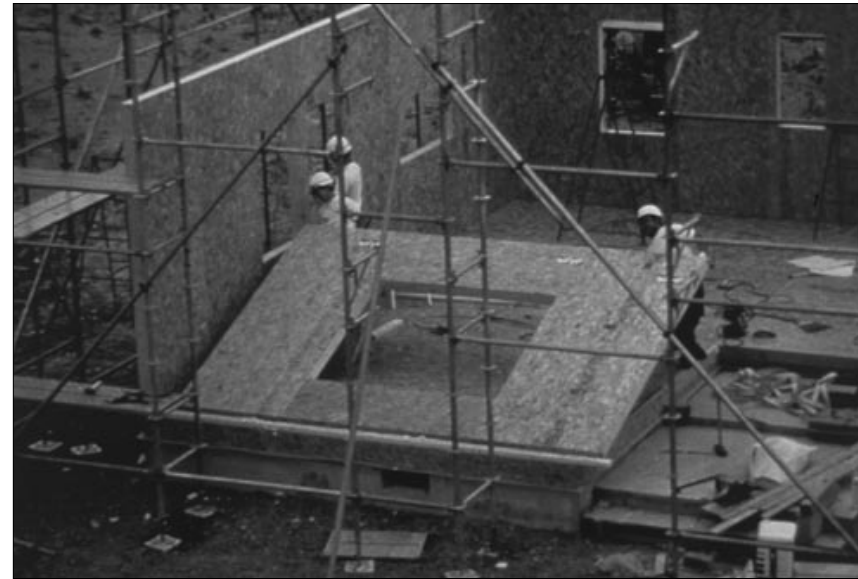

This entire suburban development is made of SIPs, which can be used for outside walls and roofs. Interior partitions are made of steel studs. The resulting houses are traditional in appearance.

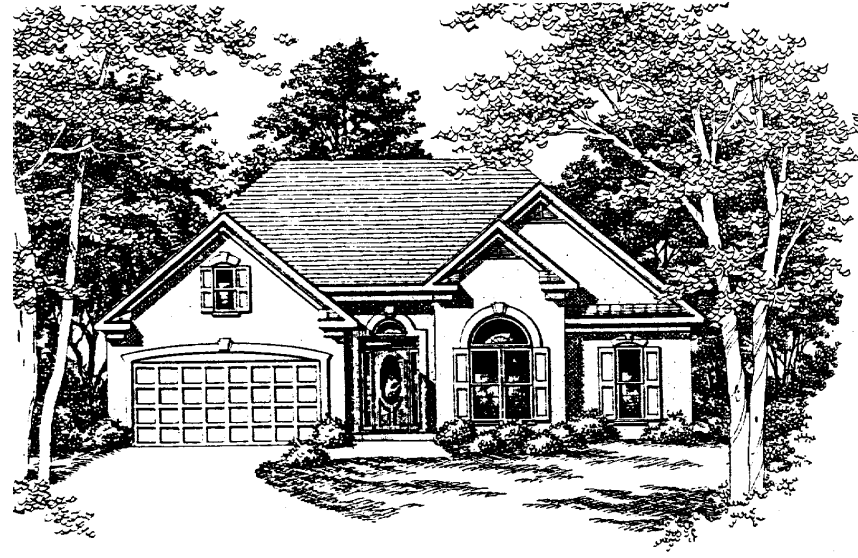
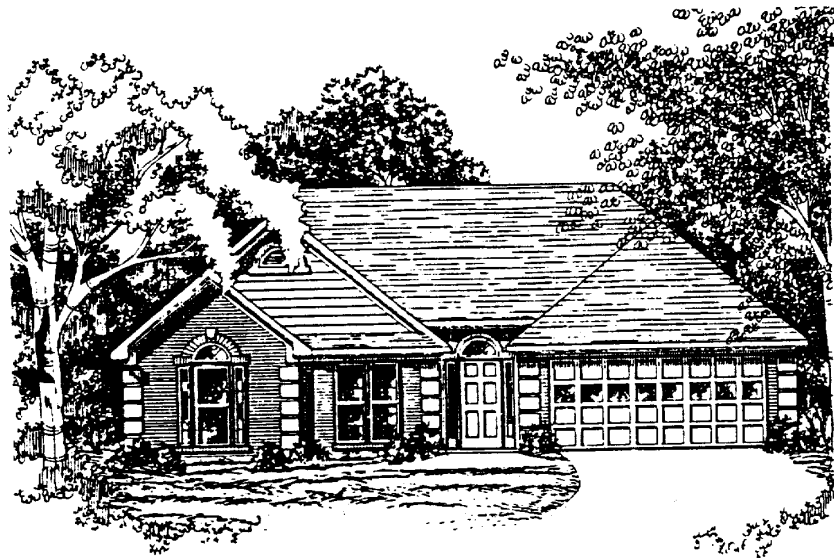

CROWN HILLS

Alpine, California

The Crown Hills development offers first-time home buyers entry-level 1,685 square-foot home on a 6,000 square-foot lot, selling below median in the very desirable and costly area. The development is approximately 65 percent complete, with scheduled completion in 1998. The entire development is constructed of structural insulated panels (SIPs), including the exterior walls and the roof. RJT Builders claims to be the only production builder in the country using SIPs on a regular basis, and Crown Hills is the first tract development in the U.S. built with the SIPs technology. The panels consist of a core of expanded polystyrene (EPS) foam insulation faced with 1/2-inch sheathing. The material is structural resilient, does not warp, and is highly energy efficient. Comparison with comparable homes in the area reveals that, according to the local utility, the average utility bill for June is \$130, while the Crown Hills units were under \$57. RJT estimates that SIPs houses use approximately a third of the lumber of comparable stick-built construction, yet the SIPs houses are stronger and sturdier in comparison.



PROJECT PROFILE

Housing Type

Detached single-family houses on 217 acres.

Technology and Design

Homes construction is of structural insulated panels (SIPs), which speed erection process and enhance energy efficiency.

Project Size

319 units, averaging 1,685 square feet.

Housing Price

Units are offered for an average of \$165,000; 78 percent of reported median.

Financing

Conventional mortgages.

PROJECT CREDITS

RJT Builders (*market rate for-profit builder*);

Danielian and Associates Architects (*architect*);

Premier Building Systems using AFM Corp. R-Control Panels (*SIPs manufacturer*).

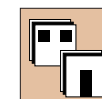

Additional Technology Information

Structural Insulated Panel Association
1511 K Street, NW, Suite 600
Washington, DC 20005
202-347-7800

Additional Project Information

RJT Builders, LLC
1425 East University Drive
Phoenix, AZ 85034
602-257-1656 (phone); 602-257-1693 (fax)



Crown Hills, constructed by a production builder who uses SIPs on a regular basis, appears to be composed of conventional frame houses. SIPs can be pre-cored in order to run plumbing and electrical conduit.



6. STEEL FRAME

The most common form of steel framing for home construction is cold-formed, light-weight steel that is easy to handle, cost effective, and a high-quality material alternative to conventional wood-framing. The increased use of steel in homebuilding in recent years is due primarily to the rising cost of lumber. Steel costs have remained stable for the past decade or more, and it is a readily available, plentiful material—important factors in the construction of affordable housing. Another attractive quality of steel is its recyclability. Magnetic separation makes steel one of the easiest and most economical materials to remove from the solid waste stream. New steel framing members are often made from recycled steel, so no new material is being mined. Steel framing is also recyclable, so that material used in today’s new homes (and construction scrap) can be used by future generations. Advantages of steel framing include cost, availability, ease of use, strength, recyclability, noncombustibility, and termite and rot resistance.

Gateway Village90
Park Skyland94
Panoan Estates96
Coachella Valley98

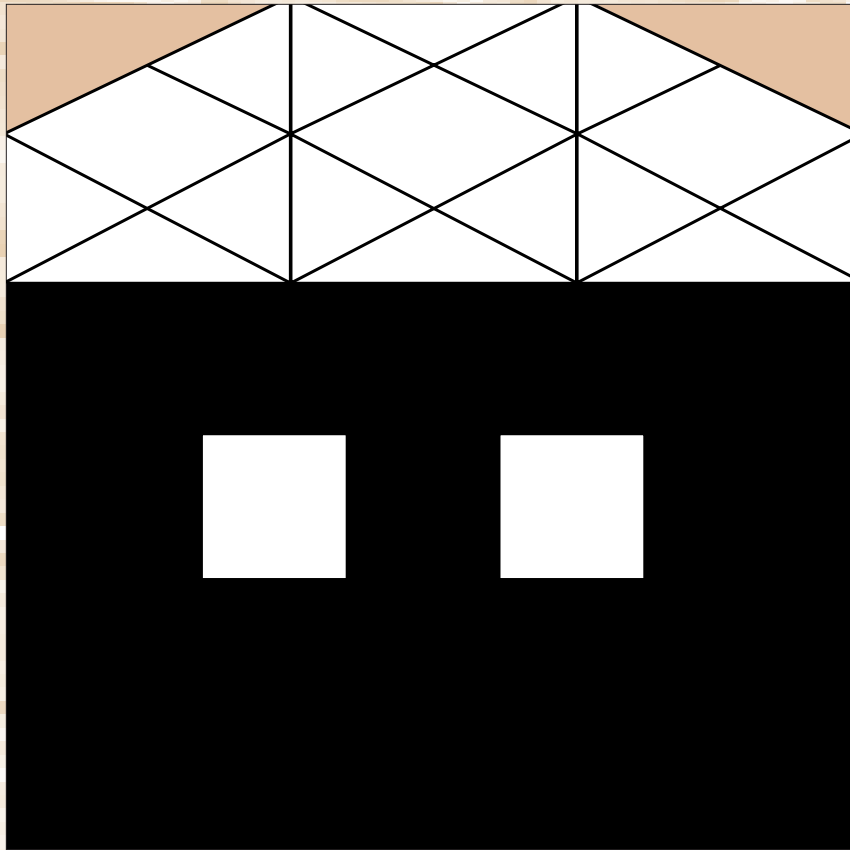

GATEWAY VILLAGE

American Canyon, California

Gateway Village is a development of single-family detached homes in American Canyon, California, a small city considered a suburb of the San Francisco Bay area—one of the least affordable housing markets in the country. Gateway Village homes use moment-framed steel-framed construction, a viable alternative framing material to dimensional lumber, which has gained attention recently. Moment-framed construction uses a large rigid frame to provide structural support, much like timber-framed construction. Although moment-framed construction employing hot-rolled steel material formed in a mill is fairly common, this project uses cold-formed steel for the structural frame. Cold-formed steel is available from many sources and increases the potential suppliers of the moment-framed structure. An advantage of moment-framed steel construction is that most of the exterior walls are “curtain-walls,” non-structural enclosures that can be built with thinner material. This method decreases the total amount of steel required for a particular home, lowering material costs and providing simplified attachment of sheathing, insulation, and siding.



PROJECT PROFILE

Housing Type

Single-family detached houses on a suburban site.

Technology and Design

Structural frames are of cold-rolled steel with moment connections more commonly found in commercial applications.

Project Size

118 units averaging 1,750 square feet.

Housing Price

Units average \$155,000; 87 percent of reported median.

Financing

Conventional mortgages.

PROJECT CREDITS

Gateway Development (*developer*);
George Meier & Associates (*architect*).

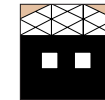

Additional Technology Information

American Iron and Steel Institute
1101 17th Street, NW, Suite 1300
Washington, DC 20036
800-79-STEEL (phone); 202-463-6573 (fax)

Additional Project Information

Gateway Development, L.L.C.
13690 East Fourteenth Street
San Leandro, CA 94578
510-351-2250 (phone); 510-351-2252 (fax)

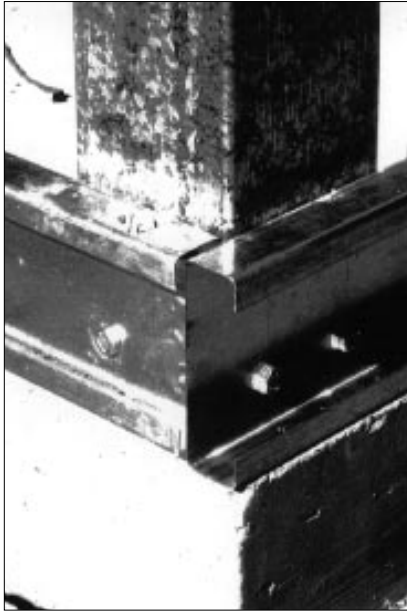

Moment frame steel framing of this house is different than conventional steel framing, which mimics wood-frame construction. Moment framing allows exterior and interior walls to be infilled similarly to timber-frame construction.



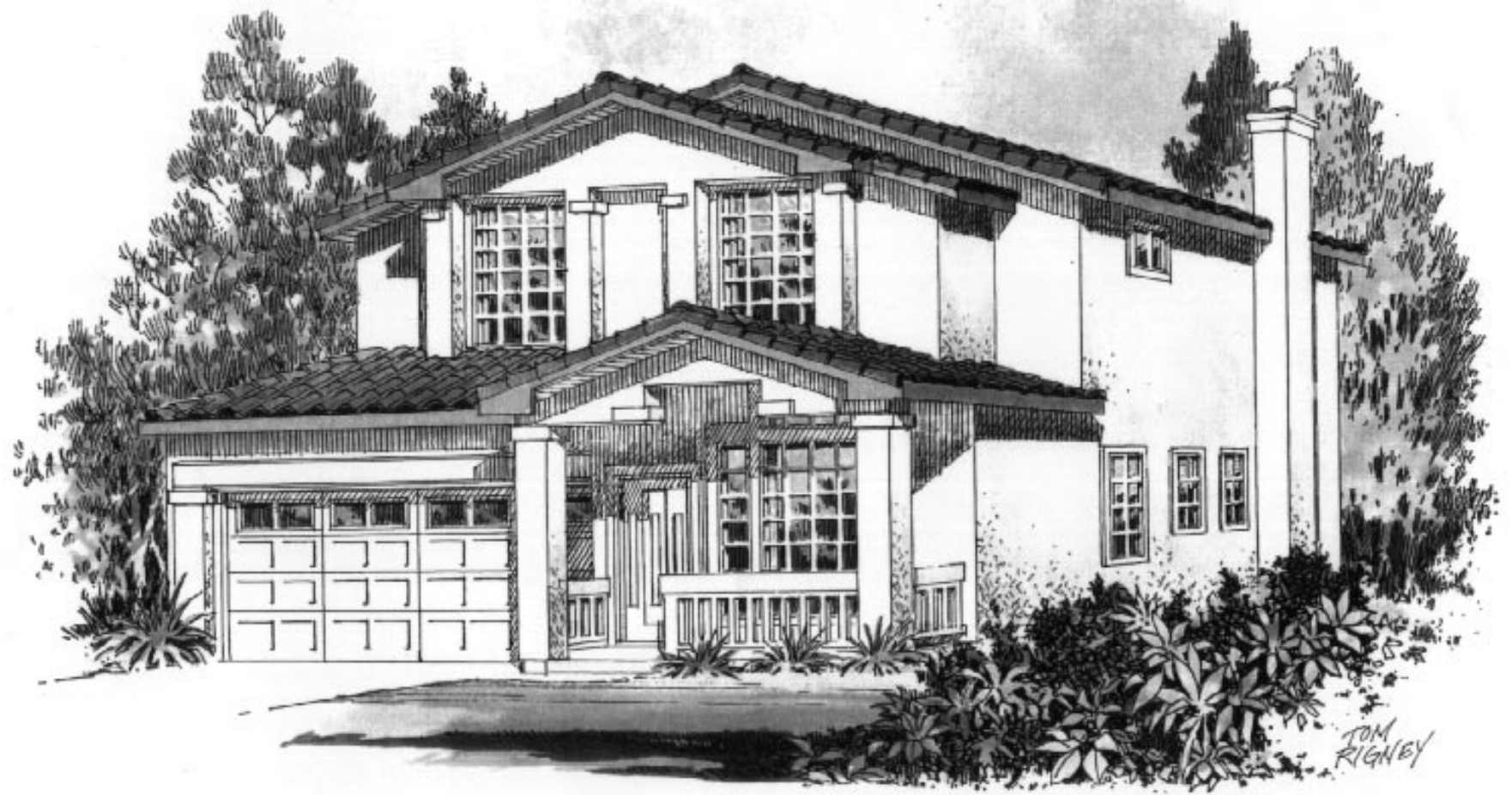



Steel-frame houses appear to be conventional stick-built wood construction, in a variety of styles and exterior finish materials.



PARK SKYLAND

Washington, DC

The Park Skyland project, developed by the D.C. Habitat for Humanity, features two steel-framed demonstration townhouses in a development of 34 townhouses on a 1.92-acre site within the city. Although steel has been used in commercial construction for many years, its use for framing homes is growing due to the volatility of lumber prices. Metal studs, floor joists, and roof trusses are commercially available in a variety of dimensional shapes and sizes, but are not commonly used for framing in the D.C. region. The steel framing contains recycled materials, is recyclable, provides termite protection, and will not shrink or split. It also offers an affordable alternative when lumber prices rise in price. The two Park Skyland homes offer homeownership opportunities with average monthly mortgage payments approximately \$170 thanks to Habitat financing. The homes were built by DC Habitat in cooperation with the American Iron and Steel Institute (AISI) and the National Association of Home Builders (NAHB). AISI donated all of the steel framing materials for the two townhouses.



Steel-frame components—such as roof structure and walls—were in some cases preassembled and then positioned by work crews and cranes. Houses were finished with durable, low-cost and low-maintenance materials.

PROJECT PROFILE

Housing Type

Single-family townhouses in an existing development.

Technology and Design

Houses constructed with steel studs, steel floor joists, and steel roof trusses, made of recycled-content material.

Project Size

Two units of 1,250 square feet.

Housing Price

Units offered for \$61,000; 30 percent of reported median.

Financing

Steel framing materials provided at no cost; Habitat for Humanity donated labor; owner provided sweat equity.

PROJECT CREDITS

D.C. Habitat for Humanity

(builder/developer), Carolyn A. Casperson (executive director);

American Iron and Steel Institute

(project participant);

National Association of Home Builders

(project participant).

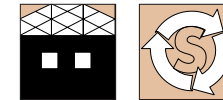

Additional Technology Information

American Iron and Steel Institute
1101 17th Street, NW, Suite 1300
Washington, DC 20036
800-79-STEEL (phone); 202-463-6573 (fax)

Additional Project Information

D.C. Habitat for Humanity
P.O. Box 30884
Washington DC, 20030-0884
202-563-3411 (phone); 202-562-4336 (fax)



PANOAN ESTATES

Los Lunas, New Mexico

Panoan Estates is a development of entry-level single-family attached and detached homes in Los Lunas, New Mexico, a bedroom community about 25 miles south of Albuquerque. The single-story, ranch style homes are designed in a typical southwestern architectural style. The structural walls and roof trusses are constructed of light gauge steel panels built by unskilled labor in a controlled factory environment. The manufacturer's long-range plan is to spur job creation and strengthen the local economy with mini panelizing plants located in depressed regions. The factory-setting and low-cost labor reduces fabrication costs and lowers job-site waste without a loss of quality workmanship. Job-site labor costs are also reduced since low-skilled workers can rapidly erect the panels. Recyclable steel components are used in place of wood, lessening the drain on natural resources. The manufacturer reports that the framing contains 66 percent recycled steel. The sale price includes a \$500 landscape allowance to encourage buyers to maintain and take pride in their front yards.



PROJECT PROFILE

Housing Type

Single-family detached houses on suburban lots.

Technology and Design

Houses constructed with panelized steel stud walls and steel trusses fabricated in a factory.

Project Size

60 units between 1,051 and 1,188 square feet.

Housing Price

Units are offered for an average of \$89,900; 71 percent of reported median.

Financing

Conventional mortgages packages available through developer.

PROJECT CREDITS

The House Factory (*steel panelized home manufacturer*), Johnnie F. McDonald (*president*); **New Mexico Sun Homes, Inc.** (*builder*).

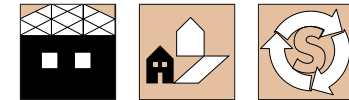

Additional Technology Information

American Iron and Steel Institute
1101 17th Street, NW, Suite 1300
Washington, DC 20036
800-79-STEEL (phone); 202-463-6573 (fax)

Additional Project Information

The House Factory
596 Carmel Road
Belen, NM 87002
505-861-1277 (phone); 505-861-2357 (fax)

Components such as walls and roof trusses are assembled in a factory, transported to the site, and then positioned by unskilled workers. Exterior finish material are applied in the field.



COACHELLA VALLEY HABITAT FOR HUMANITY

Cathedral City, California

This newly patented building product is a foamed cement insulated metal frame building system. Environmentally friendly, the system is comprised of recycled steel, Portland cement, fly-ash (the waste product of coal-burning power plants), and fibers with a foaming agent to encapsulate air. Manufactured in a factory, the two-foot-wide panels are relatively light-weight (approximately 175 pounds) and can be used to erect an average-size house by an unskilled labor force in two days. The same workers can fabricate the steel roof trusses and erect them in an additional two days. Considerable energy savings and increased comfort have been reported by residents. The assembled foam panels provide a thermal mass to moderate interior temperature swings, reducing heating and cooling demands. The foundation system is steel-formed and employs polystyrene to boost insulation value. This OTW (Other Than Wood) building system, which is also fire resistant, has the potential to lower both construction and life-cycle costs and increase comfort in homes for first-time buyers.



PROJECT PROFILE

Housing Type

Single-family detached units.

Technology and Design

Constructed of a steel and concrete panel system designed to speed construction and enhance energy performance.

Project Size

3 to 6 units on scattered sites, at 1,250 square feet.

Housing Price

Units average \$65,000; 58 percent of reported median.

Financing

Sweat equity; buyer-friendly mortgage program.

PROJECT CREDITS

Habitat International (*developer*);

Insu-Form Inc., John H. Hacker

(*engineer, designer/planner*);

Omega Transworld Ltd. (*manufacturer*).

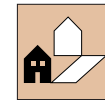
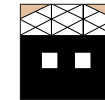

Additional Technology and Project Information

Insu-Form, Inc.

2721 Thornhill Road

Puyallup, WA 98374

206-848-5291 (phone); 206-840-1186 (fax)



* OTW (other than wood) BUILDING SYSTEM* COMPOSED OF HOPKIND CEMENTITIOUS FIBER REINFORCED CELLULAR STRUCTURE NON-ABSORPTIVE AND IMPERVIOUS TO AIR CUT WITH HAND SAW AS REQUIRED TO INSTALL PLUMBING. WFT WHICH OF OTW MATERIAL-2000 PSI, 2000 PSI DRY COMPRESSIVE STRENGTH OF APPROX 100 PSI

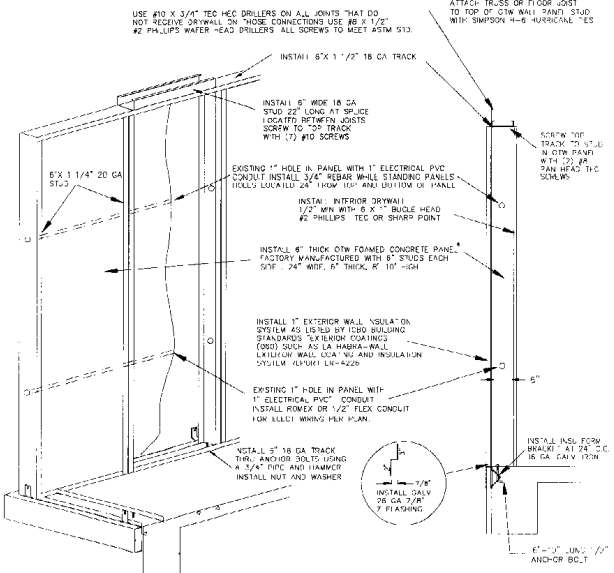

NOTE: THE WALL SECTION IS MADE BY A 1 1/2\"/>

ATTACH TRUSS OR FLOOR JOIST TO TOP OF OTW WALL PANEL STUD WITH SIMPSON 4-6 HURRICANE TIES

NOTE: OTW PANELS ARE ALSO AVAILABLE 3 5/8\"/>



This project uses a steel-framed wall panel system which is infilled with panels of foamed concrete. The light-weight panels can be lifted into place and fastened by unskilled work crews. Steel is also used for concrete foundation forms.

7. COHOUSING

The single-family detached home has long been the American dream. Recently, however, more people have turned to cohousing—a form of housing, with its roots in the Netherlands, that attempts to provide a strong sense of community along with private homes. In cohousing, a group of future residents participates in a design process that emphasizes shared facilities—such as a common house with a large dining room, community kitchen, sitting room, laundry, children’s room, guest rooms, and workshop—and an overall site plan that encourages resident interaction. The private homes in these communities have all the spaces normally found in conventional housing, though kitchens tend to be somewhat smaller, and they may lack a washer/dryer. Ownership tends to be conventional: most of the occupied cohousing communities are set up as condominiums or planned-unit-developments, while others are organized as cooperatives. Cohousing developments in the U.S. are fairly recent (since the early 1990s) and have proven a model for affordable housing, as many of the construction and maintenance costs are shared. Often, cohousing developments are also distinguished by energy-efficient and sustainable design and construction.

Eco-Village	102
Harmony Village	106
Synergy	110
Pine Street	112
Sacramento Street	114
The Grail	116

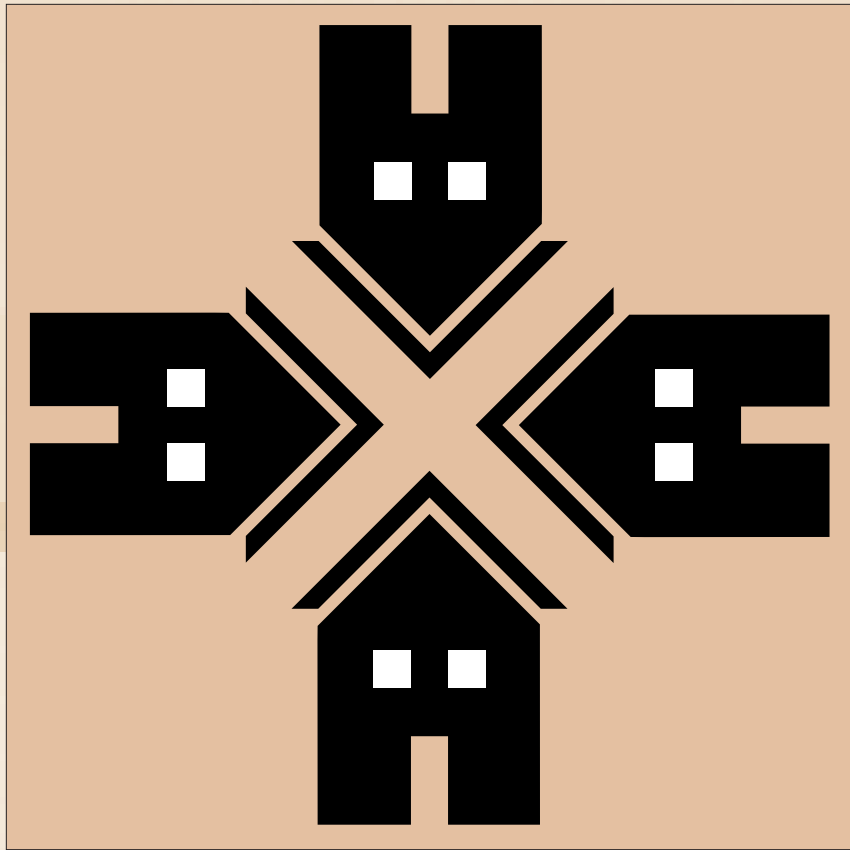

ECOVILLAGE COHOUSING COOPERATIVE

Ithaca, New York

This cohousing development, located on 176 acres two miles from downtown Ithaca, is the first of five planned neighborhoods. Each will have its own common house and 25 to 30 homes. Homes are sited in an area of poor and rocky soil leaving prime soil for agriculture. The first neighborhood has a common house and 15 clustered duplexes (30 units). Unit prices, ranging from \$90,000 to \$145,000, include a share of the common house, which provides for cooperative laundry facilities, optional shared meals, children’s playrooms, and space for workshops, home offices, and relaxing. Three units have a fully accessible first floor. EcoVillage is designed to foster environmental conservation as well as community. Energy conservation techniques include design and placement of homes to maximize solar gain, common energy systems for hot water and space heating, air tight construction, super-insulation, and placement of ducts in conditioned space. South-facing roofs allow for the eventual addition of photovoltaic panels. Low-flow showers and faucets conserve water. Compact and indirect fluorescent fixtures and day-lighting use reduce energy.



PROJECT PROFILE

Housing Type

Duplex units with shared common spaces.

Technology and Design

Design emphasizes shared living spaces for communal meals and other gatherings, with private spaces for sleeping and family life; passive solar design strategies; various sustainable design features.

Project Size

30 units, averaging 1,200 square feet.

Housing Price

Units average \$110,000; 70 percent of reported median.

Financing

Conventional mortgages.

PROJECT CREDITS

EcoVillage CoHousing Cooperative (*developer*);

HouseCraft Builders, Inc., Jerold and Claudia Weisburd (*design/build team*).



Additional Cohousing Information

The CoHousing Network
P.O. Box 2584
Berkeley, CA 94702
510-486-2656 (phone)

Additional Technology and Project Information

EcoVillage CoHousing Cooperative
P.O. Box 25
Ithaca, NY 14851-0025
607-255-8276 (phone); 607-255-9985 (fax)

EcoVillage is arranged along the natural contours of the site, and incorporates several passive solar design features to make it energy efficient and sustainable.

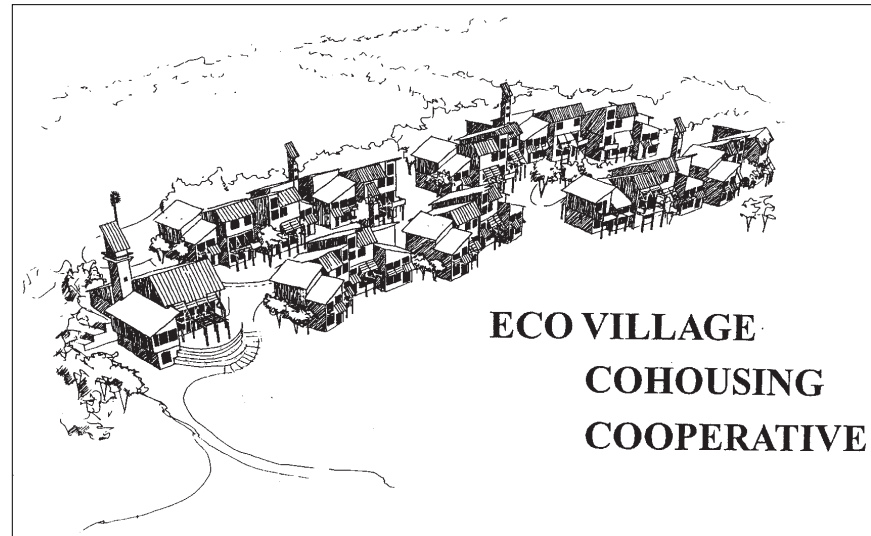

ECO VILLAGE COHOUSING COOPERATIVE

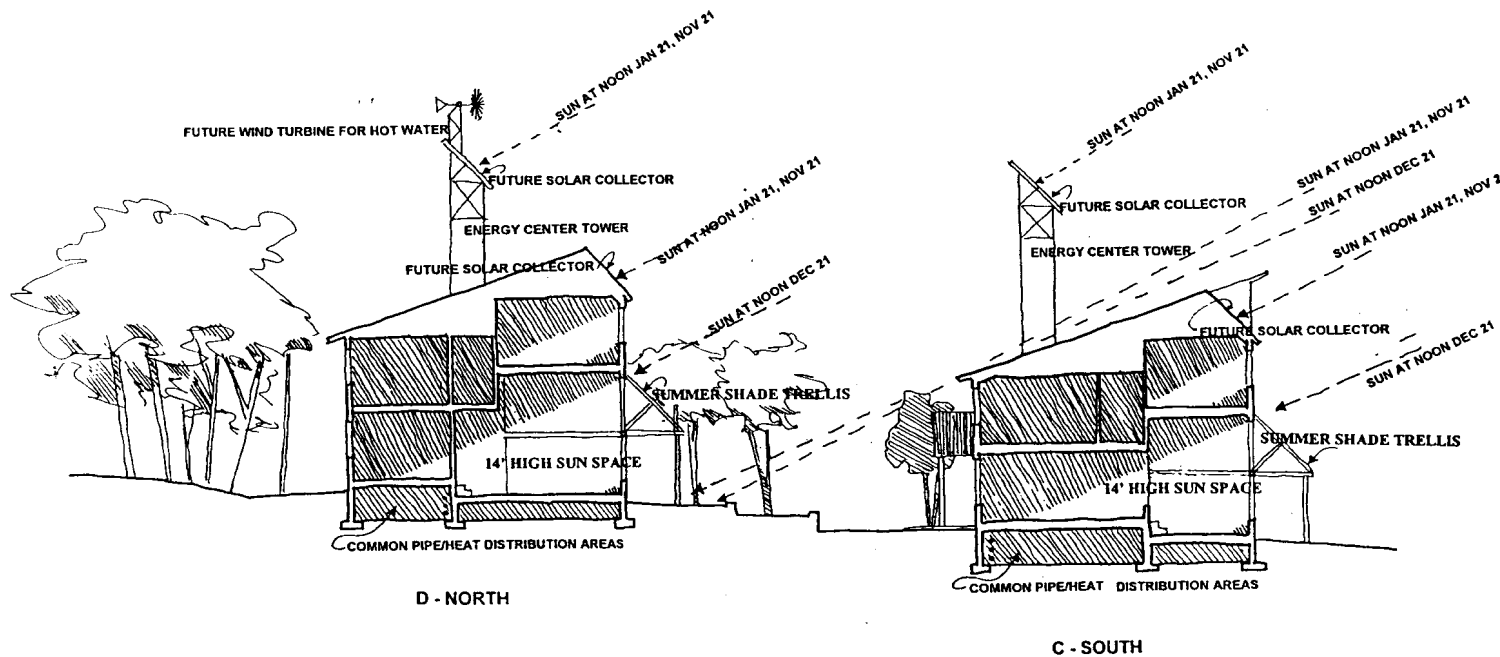



Energy performance is boosted with cellulose insulation in the walls and roofs. Common areas are distinguished by open spaces and views out to the site. Materials were chosen for ease of maintenance and minimal environmental impact.

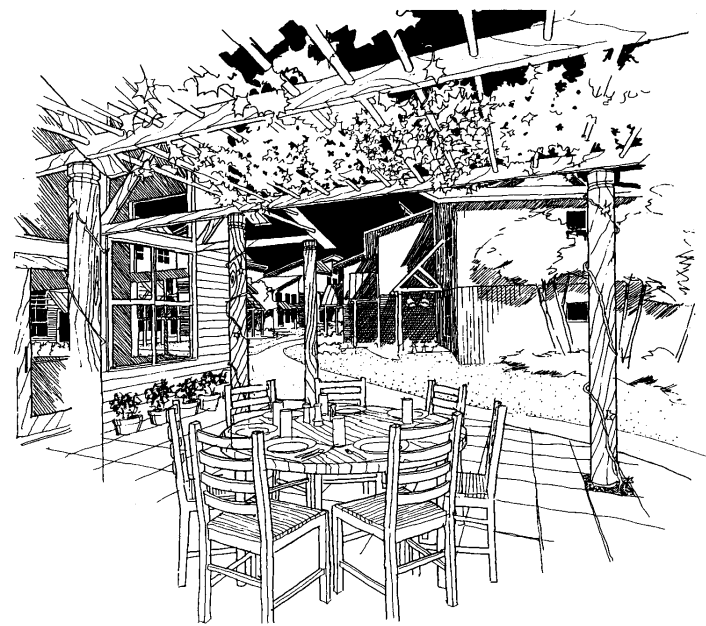
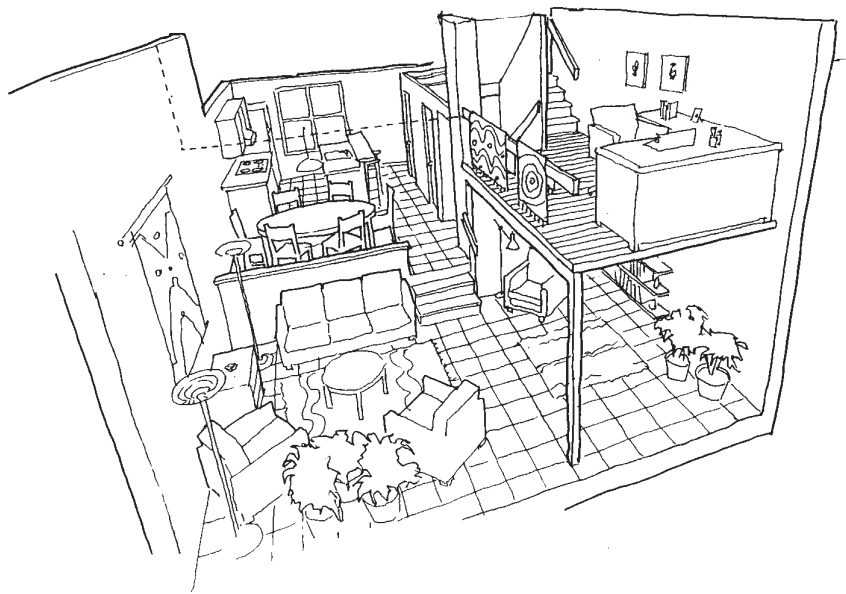

HARMONY VILLAGE

Golden, Colorado

Resident objectives for Harmony Village include creating a community that is economical to build and to maintain, living in an environmentally-sensitive way, balancing the need for individual privacy with the benefits of community living, and encouraging resident diversity. Residents participated in planning the development and provided much of the equity financing. Located on 5.5 wooded acres, the “village” includes 27 homes clustered around small courtyards and the common house with a kitchen/dining area for shared meals, and space for child care, teenage activities, common storage, laundry facilities, workshops, and guest rooms. Pedestrian pathways link the village; access roads and parking line the periphery. About half of the area is reserved as open space. The low-maintenance southwestern “pueblo” style one- to four-bedroom homes share a common house. Harmony Village homes feature energy efficient and resource conserving designs and construction to provide lowered operating and maintenance costs. All homes are sited for maximum solar exposure and plumbed for future solar hot water.



PROJECT PROFILE

Housing Type

Clustered single-family units with shared common spaces.

Technology and Design

A cohousing design that emphasizes shared common spaces for socializing and shared meals, with units designed to encourage communal living. Passive solar design features and energy efficient construction techniques.

Project Size

27 units, averaging 1,300 square feet.

Housing Price

Average price of a unit is \$150,000; 80 percent of reported median.

Financing

Units qualify for energy-saving mortgages.

PROJECT CREDITS

Wonderland Hill Development

Company, James W. Leach (*president*);

Synergy Design, Matt Worswick (*project designer*).



Additional Technology Information

Synergy Design
3825 Clay Street
Denver, CO 80211

Additional Project Information

Wonderland Hill Development Co.
745 Poplar Ave.
Boulder, CO 80304
303-449-3232 (phone); 303-449-3275 (fax)



Common building at Harmony Village expresses the local architectural vernacular of adobe construction, which is a sustainable choice in this region. Pedestrian ways link units and common areas around the site.





Residences are scaled to fit into the local landscape. Finishes are simple and low maintenance inside and out. Emphasis is placed on low-energy mobility, such as footpaths.





SYNERGY COHOUSING COMMUNITY

Delray Beach, Florida

Modeled on a Scandinavian housing design that combines the autonomy of private homes with the advantages of shared community resources, this project includes a common house with a kitchen/dining area, recreational and sitting rooms, laundry, day care, guest room, office, and a meeting room. Living units throughout are two-bedroom. All homes are built with insulating concrete forms, using rigid expanded polystyrene insulation as the form material. After the concrete is poured and sets, the EPS forms remain to provide a highly insulated structure. The walls for Synergy Cohousing will have an R-value of 27. Each building will also incorporate a passive solar cooling system to assist in heat removal when humidity control is not required. The system uses a central stairway as a chimney stack with louvers at the top to pull the air from the living units. All units will be designed to facilitate extensive cross-ventilation and transoms above all doorways and hallway windows. The project also uses active solar hot water system for each building with a supplemental electric heater.

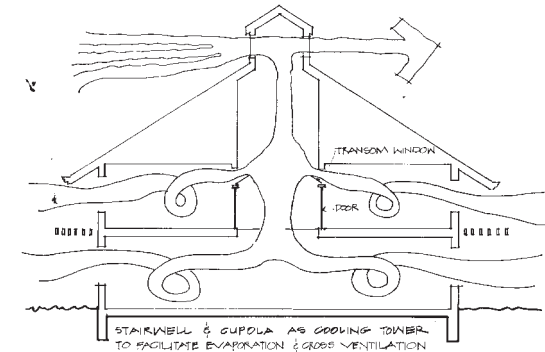

PROJECT PROFILE

Housing Type

Townhouse single-family units with shared common spaces.

Technology and Design

Design emphasizes shared living spaces for communal meals and other gatherings, with private spaces for sleeping and family life. The project incorporates passive solar design strategies, with some active systems for domestic hot water. Insulating concrete forms enhance energy performance.

Project Size

32 units, averaging 1,250 square feet.

Housing Price

Units start at \$125,000; 91 percent of reported median.

Financing

Developed by not-for-profit organizations.

PROJECT CREDITS

Delray Grove (*cohousing group*);
The CoHousing Company
(*co-developer*);
McCamant and Durrett (*architect*).

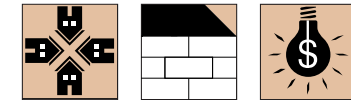

Additional Cohousing Information

The CoHousing Network
P.O. Box 2584
Berkeley, CA 94702
510-486-2656

Additional Technology and Project Information

The CoHousing Company
1250 Addison Street, Suite 113
Berkeley, CA 94702
510-549-9980 (phone); 510-549-2140 (fax)

Natural ventilation is used to cool units in this hot, humid climate. Houses are arranged to promote foot traffic and use of common areas between structures. Insulated concrete forms were used to promote better energy performance.

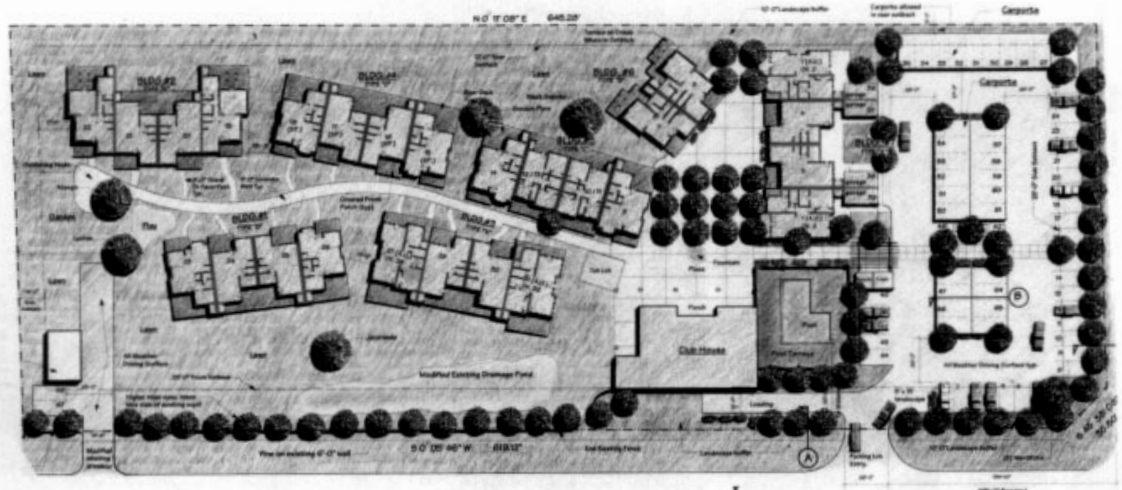

PINE STREET COHOUSING

Amherst, Massachusetts

The Pine Street cohousing development consists of four duplexes and a common house. The common house provides a large kitchen/dining area along with guest quarters. The development is clustered to allow separation of living space from the automobile and increase the extent of open spaces. Optimal-value engineering was used in the framing design to minimize dimensional lumber requirements. The 2x6 wall framing at 24 inches on-center has horizontal furring to allow 7 inches of dry-blown cellulose insulation. Each unit has a geothermal heat pump that transfers heat between the ground and the home at efficiencies greater than conventional air-source heat pumps. Another energy efficiency measure in the development includes daylighting to minimize the need for auxiliary daytime lights. The roofs are oriented and sloped to accommodate the future addition of photovoltaic panels. Extensive waste management was used during construction. Cardboard and metals were recycled, drywall was ground up and spread over the site, and wood was sorted for either reuse or as a fuel in wood stoves. Only 15% of the total project waste was landfilled.



PROJECT PROFILE

Housing Type

Semi-attached duplex units with shared common spaces.

Technology and Design

Design emphasizes shared living spaces for communal meals and other gatherings, with private spaces for sleeping and family life.

Project Size

8 units, ranging from 1,000 to 1,750 square feet.

Housing Price

Units offered from \$110,000 to \$155,000; 84 percent of reported median.

Financing

Houses developed by non-profit group; sweat equity helps make housing affordable.

PROJECT CREDITS

Pine Street Realty Trust (*ownership group*);

Bruce Coldham (*architect*).



Additional Cohousing Information

The CoHousing Network
P.O. Box 2584
Berkeley, CA 94702
510-486-2656 (phone)

Additional Technology and Project Information

Pine Street Realty Trust
155 Pine Street
Amherst, MA 01002
413-549-3616 (phone); 413-549-6802 (fax)



Geothermal heat pumps, 2x6 framing, and cellulose insulation are some of the energy-conservation features of the Pine Street cohousing community. Units are arranged as duplexes around a common house.

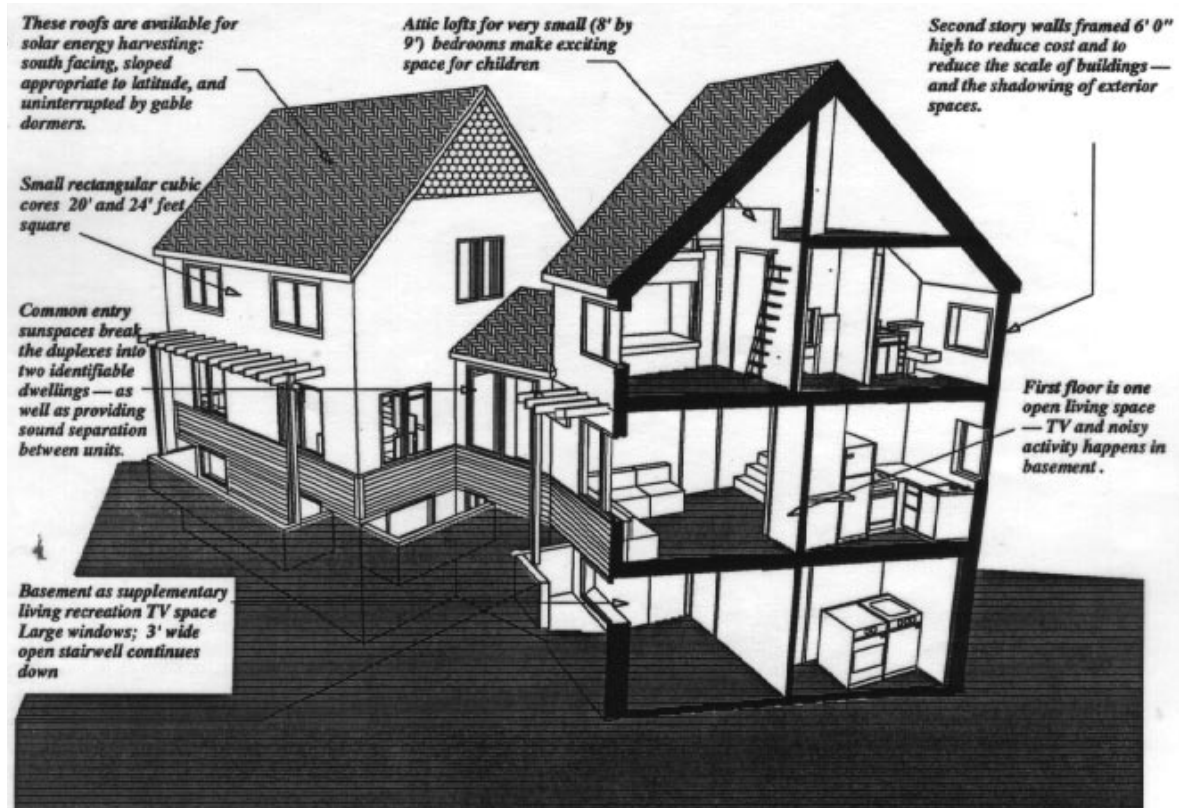

SACRAMENTO STREET COHOUSING

Berkeley, California

The design of this development is based on a Scandinavian housing model that combines the autonomy of private homes with the advantages of shared community resources. An urban infill project, this co-housing design comprises 14 units and a common house with a kitchen/dining area, meeting and social areas, laundry, child play areas, guest room, and a piano room/office. Architecturally, the design is a juxtaposition of Craftsman style, clapboard style, and Spanish stucco style, creating a microcosm of Berkeley's architecture. The homes include passive solar heating (active domestic hot water preheat and active space heating) with extensive south-facing windows. Interior walls are built with a double layer of 5/8-inch gypsum wallboard for thin-mass heat storage. Floors consist of 3/4-inch thick tiles on a 3/4-inch thick mortar bed. Wall radiators with built-in circulation fans provide supplementary heating. Lumber and finish woods are certified to conform with sustainable forestry practice, including no clear cutting and "weeded out" trees. Low VOC water-based paints and finishes, formaldehyde-free materials, and wool carpet with jute backing contribute to improved indoor air quality.

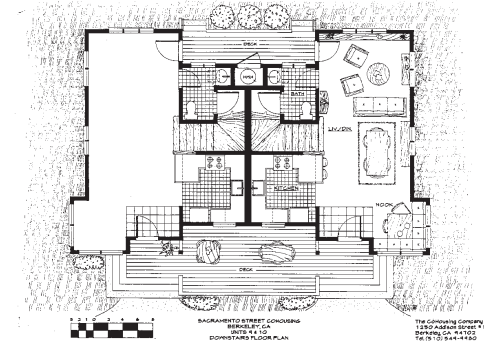

PROJECT PROFILE

Housing Type

Townhouse single-family units with shared common spaces.

Technology and Design

Design emphasizes shared living spaces for communal meals and other gatherings, with private spaces for sleeping and family life. The project incorporates passive solar design strategies, with some active systems for heating, and sustainable building materials.

Project Size

14 units, averaging 950 square feet.

Housing Price

Units average \$140,000; 68 percent of reported median.

Financing

Developed by not-for-profit organizations.

PROJECT CREDITS

Sacramento Street Cohousing

(*developer*);

The CoHousing Company

(*co-developer*);

McCamant and Durrett

(*architect*).



Additional Cohousing Information

The CoHousing Network
P.O. Box 2584
Berkeley, CA 94702
510-486-2656 (phone)

Additional Technology and Project Information

The CoHousing Company
1250 Addison Street, Suite 113
Berkeley, CA 94702
510-549-9980 (phone); 510-549-2140 (fax)

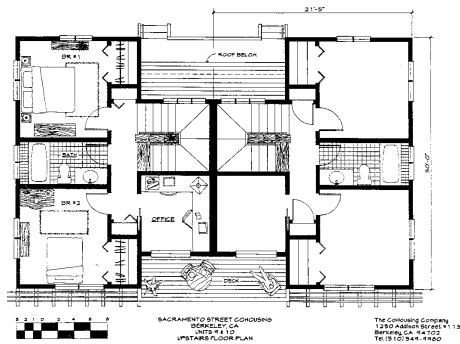

A duplex plan arrangement keeps the scale of this cohousing community residential and faithful to the surrounding neighborhood. Incorporating passive solar features such as natural lighting and overhangs for shading, the architectural design is also sympathetic to the Bay Area.



THE GRAIL COHOUSING

San Jose, California

This 35-unit development for a Latino population in an urban setting preserves a number of neighborhood traditions and accentuates independent living with shared common areas. The architect, Michael Pyatok, worked closely with the community in a series of design workshops to incorporate ideas of the people who would live there, and to create architectural imagery that connected to the ethnic traditions of the residents. The units are clustered around common open space, with parking located on the periphery of the site. A site edge that had been used informally by truck farmers to sell their produce was incorporated into the guest parking lot so that they could park their trucks. The units incorporate some engineered prefabricated building elements and recycled content materials. Passive solar features are used to maximize daylighting and shading. The community building allows meals to be shared, and a place for on-site daycare. Other encouragements to independent living include some units with home office space, and in-law bedroom suites to preserve extended families. The city is providing a second mortgage program, and some federal HOME funds are also available.

PROJECT PROFILE

Housing Type

Townhouse single-family units with shared common spaces.

Technology and Design

A cohousing design that emphasizes shared common spaces for socializing and shared meals, with units designed to encourage extended families and independent living. Some prefabricated building elements and recycled content materials.

Project Size

35 units, between 900 and 1,350 square feet.

Housing Price

Units offered for \$90,000 to \$130,000; 60 to 86 percent of reported median.

Financing

State and federal assistance to subsidize selling price.

PROJECT CREDITS

San Jose Grail Development Corp.

(nonprofit developer);

East San Jose Community Design/Planning Workshop

Participants;

City of San Jose, Department of Housing;

Pyatok Associates, Michael Pyatok, *(architect).*



The Grail cohousing community takes the form of multi-story townhouse buildings arranged around common outdoor areas. Architectural character is consistent with local vernacular.

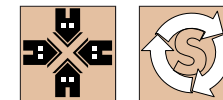

Additional Cohousing Information

The CoHousing Network
P.O. Box 2584
Berkeley, CA 94702
510-486-2656 (phone)

Additional Technology and Project Information

Pyatok Associates
339 15th Street, Suite 212
Oakland, CA 94612
510-465-7010 (phone); 510-465-8575 (fax)

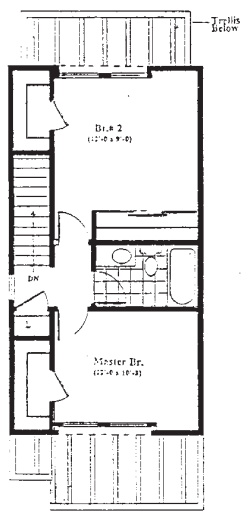

THIRD FLOOR

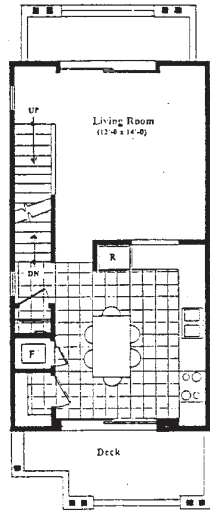

SECOND FLOOR

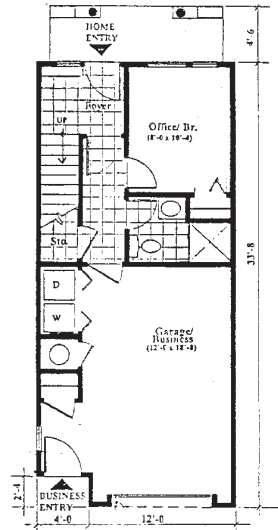

FIRST FLOOR

UNIT B

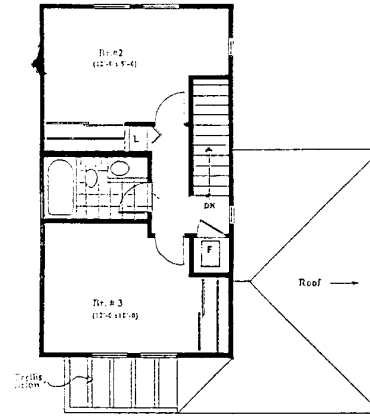

SECOND FLOOR

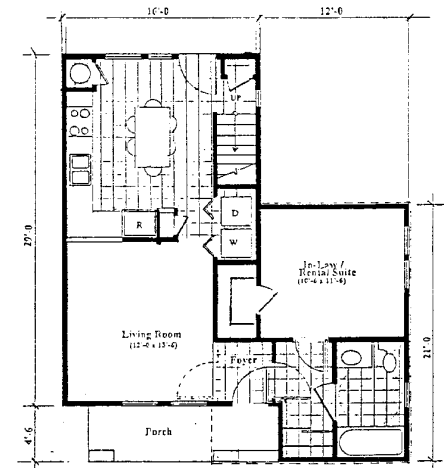

FIRST FLOOR

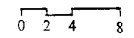

UNITS



Areas of the site were left open for recreation, community activities, and commerce such as local farmers who sell their produce. Common areas at the center of the community are protected by buildings and vegetation.

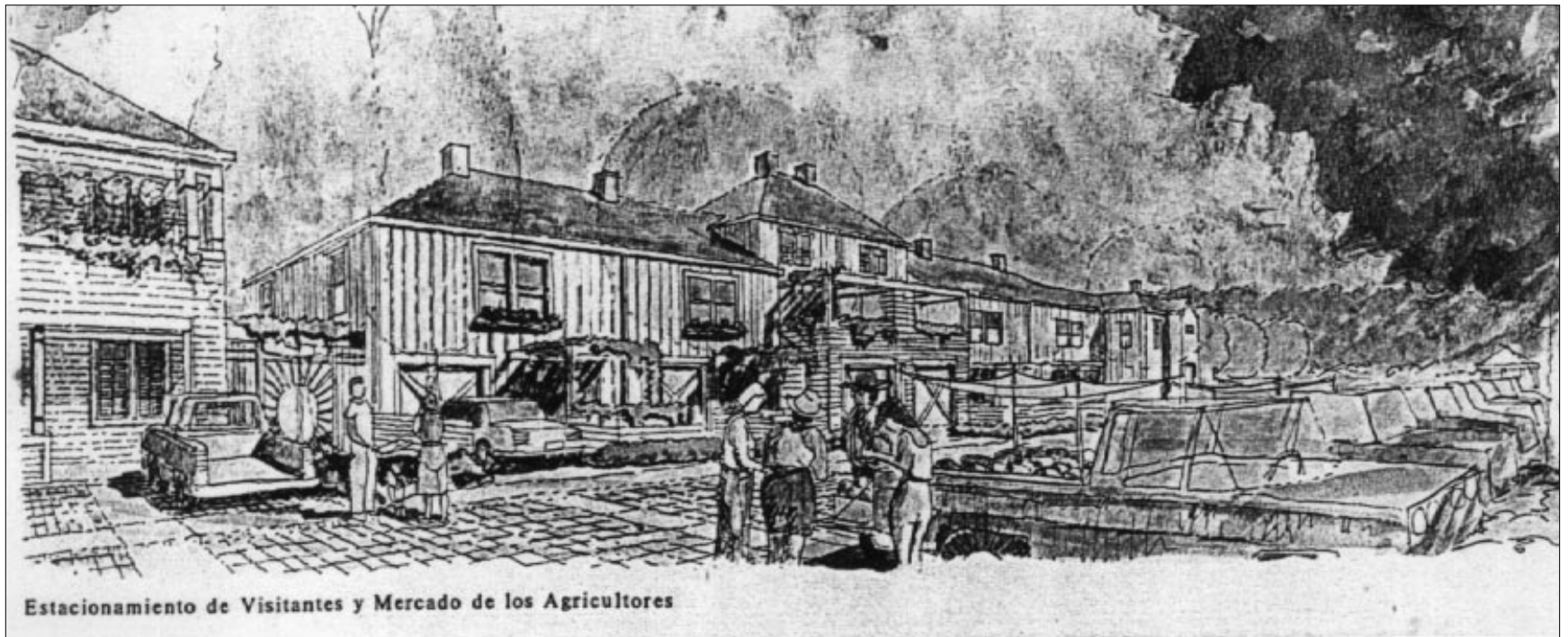
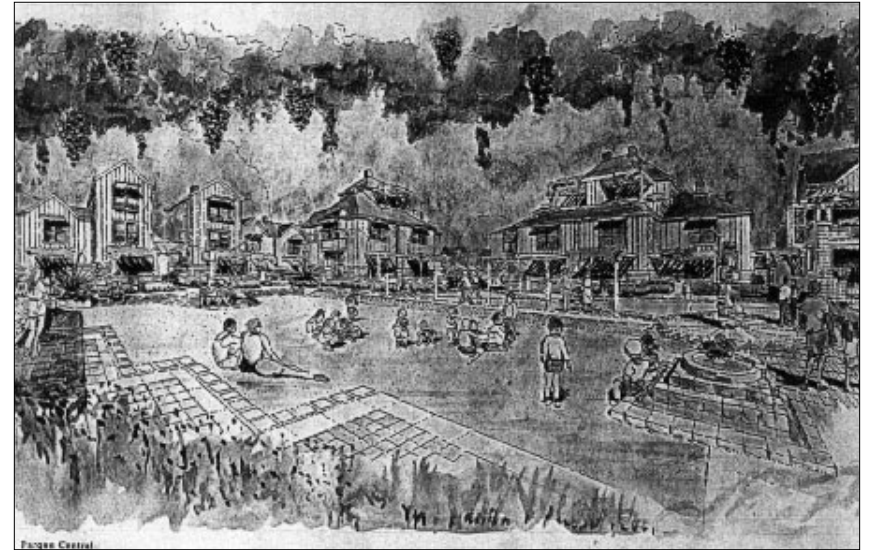

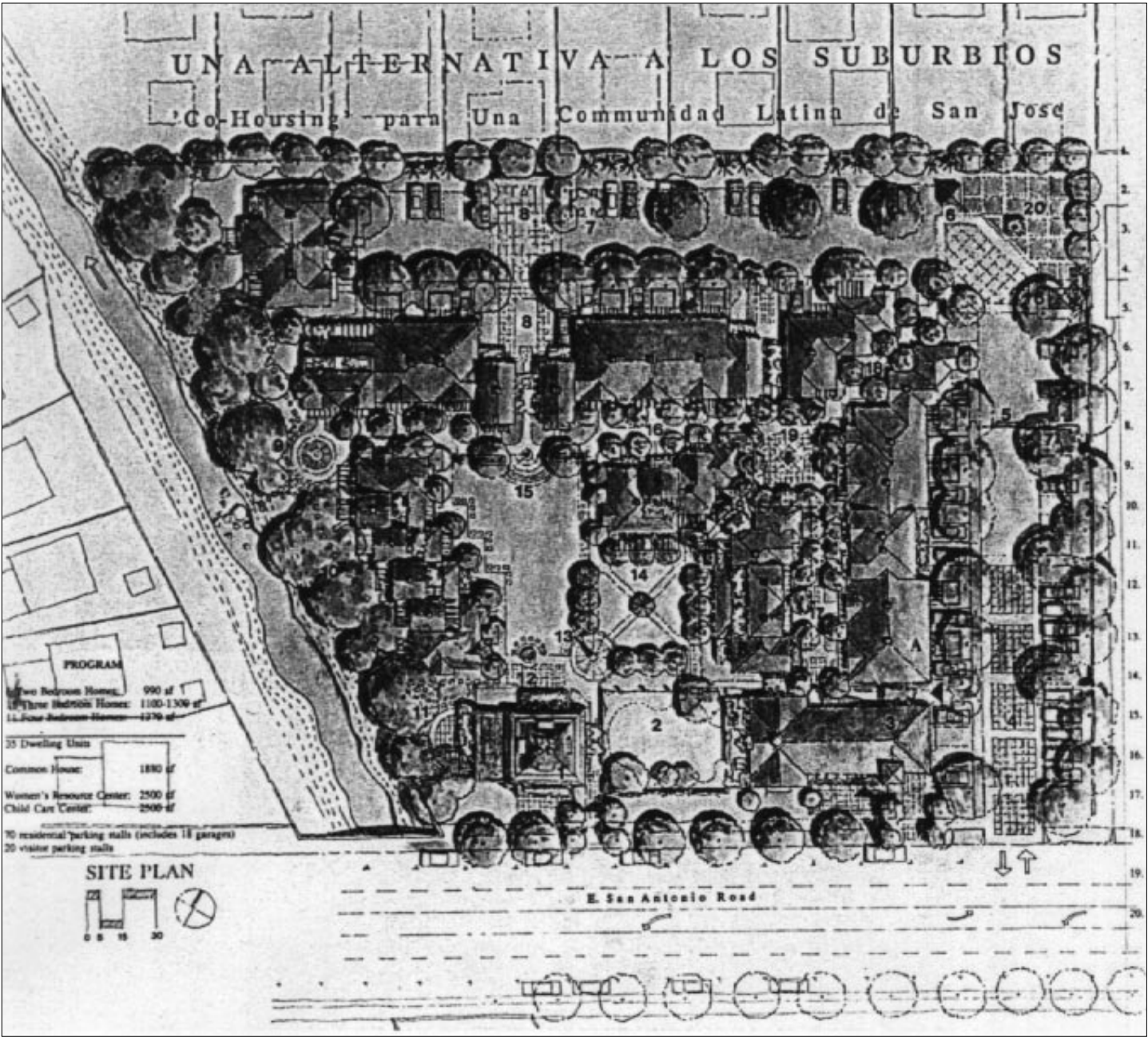

8. MASONRY/CONCRETE

Innovations in this realm of housing construction include a variety of new materials and new designs for old materials that make them more economical or easier to assemble. Insulating concrete formwork is one example where an innovation has led to faster form erection, better thermal performance, and improved construction quality. Modular, mortarless masonry wall systems that require little skill or training to erect result in lower labor costs without sacrificing appearance. Materials with little exposure in the U.S., such as Hebel blocks—which are lightweight, can be cut with a handsaw, and require no mortar—can reduce erection time and lower labor costs. A concrete modular system previously used only in commercial construction allows swift erection of single-family houses. Technology that permits the manufacture of masonry units on site allows local, low-cost materials to be used and decreases fabrication costs. These various approaches can result in faster construction, more economic use of materials, and the opportunity for unskilled, low-cost labor (such as the prospective homeowner) to be involved in homebuilding.

Cone Street	122
Knight’s Landing	124
Casas de Escudero	126
Hunters Prairie	130
Ephesian Homes	132
Park West	134
Walton County Habitat	136

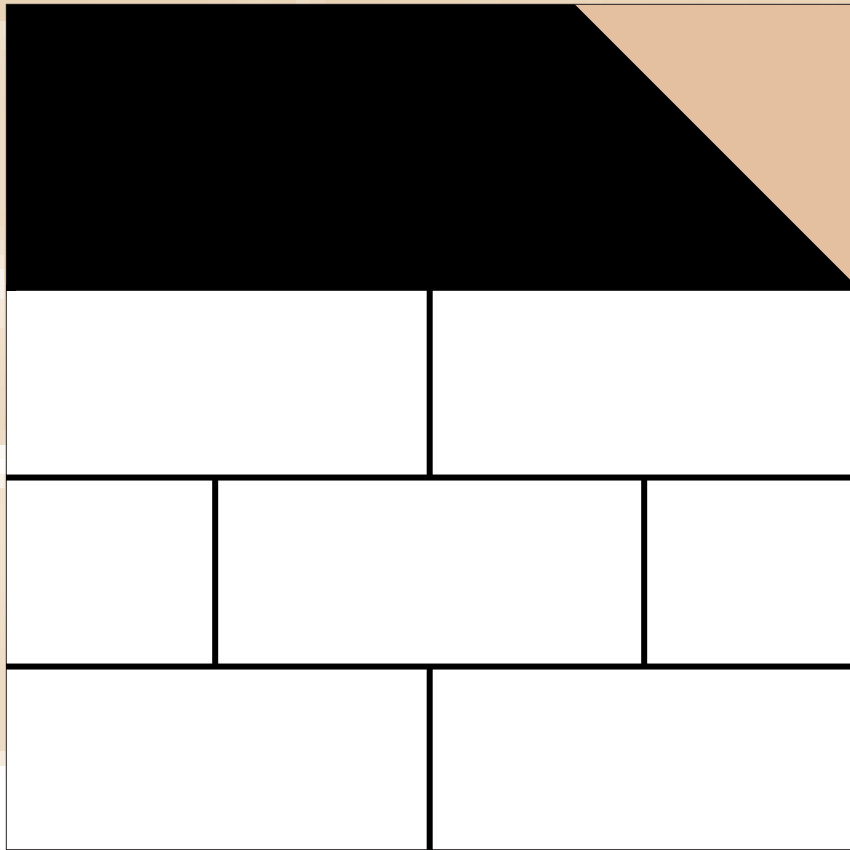

CONE STREET DEVELOPMENT

Toledo, Ohio

Cone Street is in a distressed area of Toledo. The construction of 20 to 40 new homes on inner-city lots represents a breakthrough in providing affordable housing in this market, and innovative building technology. The lots have been provided by the city at no cost to the local housing authority. Permit fees and impact fees were waived by the city. The housing authority priced alternative techniques of construction, and found that an innovative concrete module technique —previously used only for commercial construction—could save approximately 15 percent over conventional site-built housing. The system uses 12 concrete cube modules to create a 1,300-square-foot house. Modules are craned into place with penetrations between the modules aligned. The front and back of the house is then closed in with steel studs, sheathing, and siding. Roofing and interior partitions are then constructed. The thermal mass of the concrete provides heat storage for energy conservation. A second mortgage program was provided by the housing authority to reduce the price of the houses.



Concrete modules commonly used in commercial construction are assembled into a single-family house, insulated, and sheathed. The result appears to be a conventionally constructed home.

PROJECT PROFILE

Housing Type

Scattered site, infill, detached single-family housing.

Technology and Design

Innovative use of precast concrete modules that are normally employed for commercial buildings, stacked to form structure, greatly reducing construction time and cost.

Project size

20 to 40 units, 1,300 square feet.

Housing Price

Units are \$63,000; 57 percent of reported median.

Financing

Local housing authority provides \$10,000 second mortgage; city donated land; fees waived.

PROJECT CREDITS

Lucas Metropolitan Housing Authority;
Concrete Production Products, Ltd.;
City of Toledo;
Bancroft-Upton-Monroe-Association/Community Development Corp.

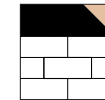

Additional Technology Information

Concrete Production Products, Ltd.
3901 South Avenue
Toledo, OH 43615
419-535-0335 (phone); 419-535-7919 (fax)

Additional Project Information

Lucas Metropolitan Housing Authority
435 Nebraska Avenue
Toledo, OH 43612
419-259-9432 (phone); 419-259-9494 (fax)

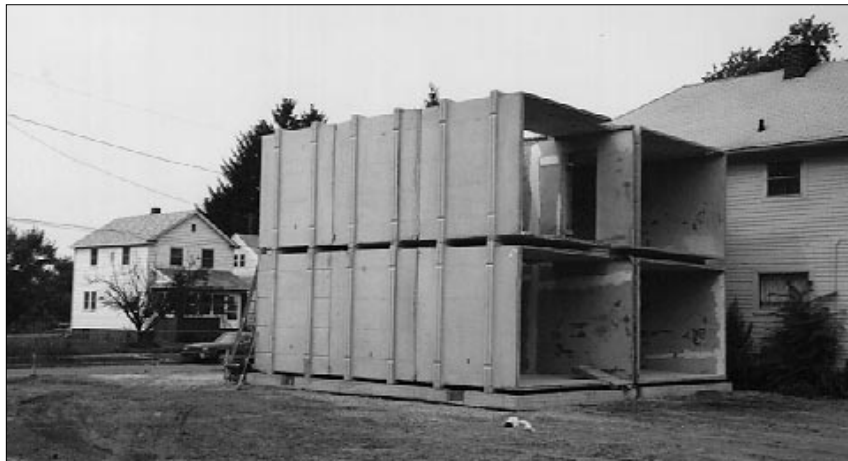
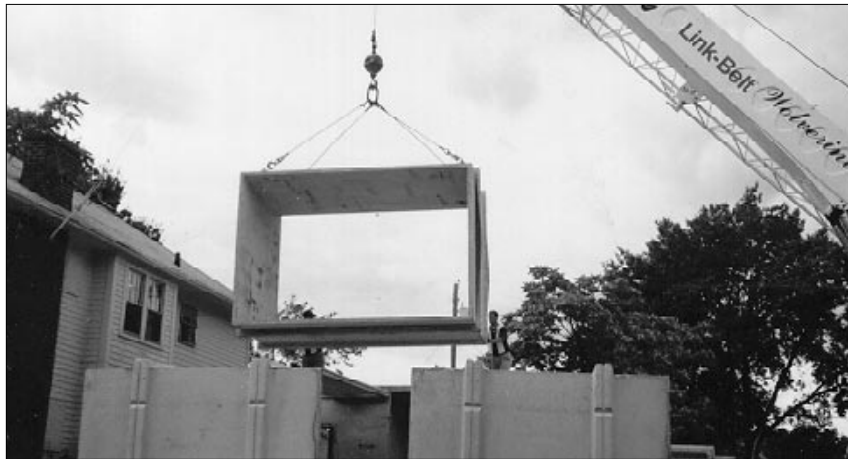
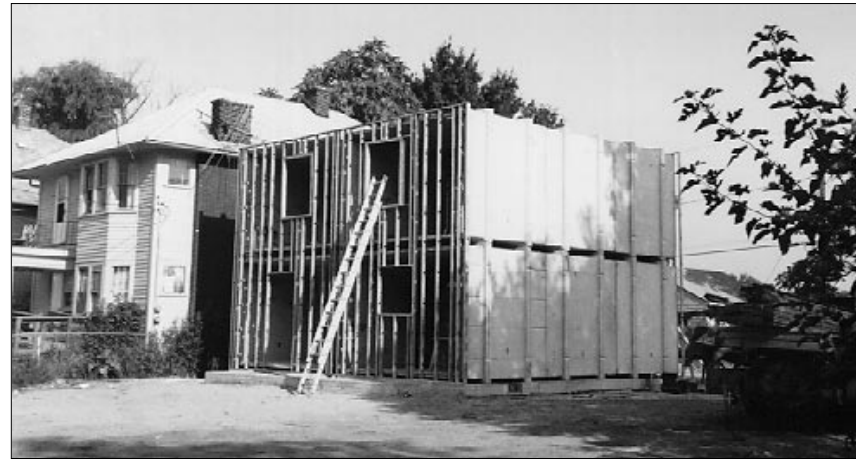

KNIGHT'S LANDING

Chestertown, Maryland

Knigh't's Landing is a development of 71 single-family detached homes on the eastern shore of Maryland. The homes are designed and constructed to enhance energy savings. All homes in phased development are slab-on-grade and use innovative light-weight, stay-in-place expanded polystyrene forms (EPS), which are filled with 3,000 psi concrete to create the exterior wall system. The forms are fire and pest resistant, made from 100% recyclable material, and reduce construction waste to as low as 2 percent. ICFSs have been found to reduce air infiltration and lower utility bills, and provide a quieter home environment by insulating the interior from outside noise. Phase I homes are equipped with electric baseboard heating. Phase II homes use hydronic radiant floor heat where hot water circulates through tubing in the concrete floors. Phase III homes will feature a roof-mounted solar system to assist in heating water for the hydronic system. The solar heat will be diverted to domestic hot water during the summer. The combination of wall structure, heating system, and solar construction provide documented energy savings and eligibility for energy-efficient mortgage assistance and power company programs.



PROJECT PROFILE

Housing Type

Single-family houses on suburban lots.

Technology and Design

Houses constructed with a variety of energy-saving features such as EPS concrete forms, increased insulation, building wrap, hydronic radiant floor heat.

Project Size

71 units averaging 1,000 square feet.

Housing Price

Units are offered for an average of \$87,000; 76% of reported median.

Financing

Financing packages provided by Rural Economic Community Development as part of its Demonstration 502 Single-Family Housing Program. Energy Efficient Mortgages and utility-sponsored programs.

PROJECT CREDITS

ROMACK & ASSOCIATES, INC.

(builder/developer), Roger K. McKnight (president).

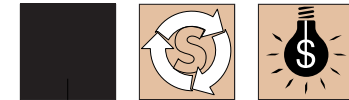

Additional Technology and Project Information

ROMACK & ASSOCIATES, INC.
1002 Washington Avenue
P.O. Box 300
Chestertown, MD 21620
410-778-6823 (phone); 410-778-6835 (fax)



Slab-on-grade construction employs light-weight EPS forms that are pest resistant and recyclable. Hydronic radiant floor heat in the slab is one of several energy-saving features.



CASAS DE ESCUDERO

Santa Fe, New Mexico

In the Casas de Escudero development, Habitat for Humanity (as developer and builder) created a method to construct low-cost adobe homes using unskilled workers and volunteers. A high production hydraulic block press was used that yields four adobe blocks per minute, or enough blocks for a 1,200-square-foot home in 9 days. Except for forming the bricks in a machine, instead of by hand, the techniques used in Casas de Escudero have roots in the American Southwest. The walls are cavity walls with insulation between to provide energy efficiency, sound protection, and longevity. The local building code officials permitted Habitat to use traditional mud plaster on the exterior walls in lieu of stucco. Large overhangs in the Casas de Escudero homes protect walls from hot summer sun and rains but allow passive solar heating in the winter. Radiant heat augments the sun as needed. The homes are available to Santa Fe families earning 50 percent or less of local median income (\$23,000 for a family of four) who meet selection criteria and provide 11 hours labor for each \$1,000 of their mortgage loans to build their home.



PROJECT PROFILE

Housing Type

Single-family detached houses.

Technology and Design

Houses constructed with traditional adobe brick made with mechanized block press. Material adds to the houses' energy efficient performance, and incorporate passive solar design strategies.

Project Size

Five units averaging 1,200 square feet.

Housing Price

Units are offered for an average of \$82,000; 44 percent of reported median.

Financing

Potential buyers must qualify by earning 50 percent or less of local median family income, meet selection criteria, and provide sweat equity.

PROJECT CREDITS

Santa Fe Habitat for Humanity
(*administration/developer/ builder*);
Rebecca Wurzbarger (*construction manager*).

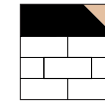

Additional Technology and Project Information

Santa Fe Habitat For Humanity
461 Acequia Madre
Santa Fe, NM 87501
505-982-6351 (phone); 505-984-9180 (fax)

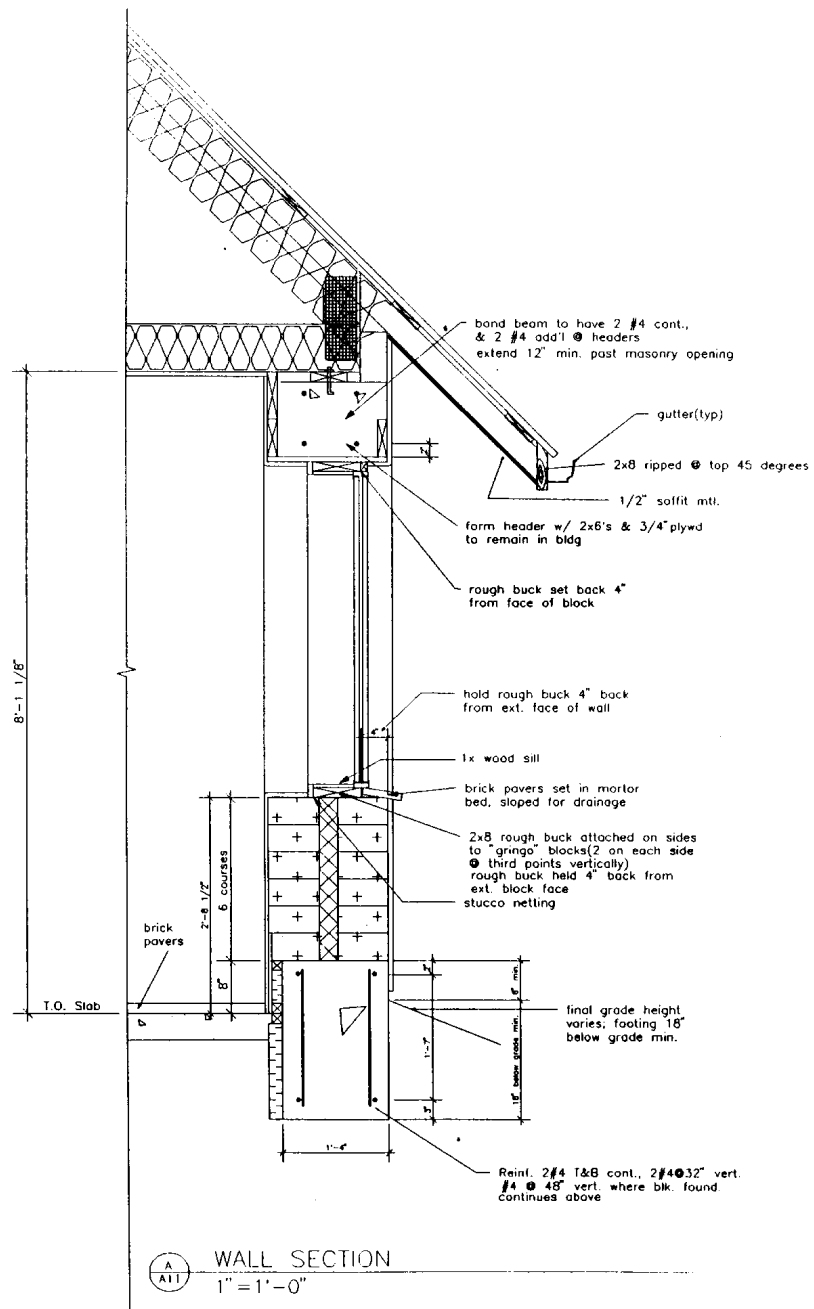

Older construction technology with a low skill level is used in an innovative way to allow low-cost construction using indigenous materials. Adobe block wall construction promotes energy conservation.





Adobe homes can be built with volunteer, low-skill labor, which enhances affordability. Adobe block walls can be finished with stucco or other cladding materials such as clapboard. Roofs are durable metal.





HUNTERS PRAIRIE

Fargo, North Dakota

The Hunters Prairie development consists of 35 energy-efficient townhouses, including some specifically designed for elderly buyers or people with physical disabilities. The homes feature innovative foundation systems that save money for the homebuyer on both the purchase price and operating costs. The insulated shallow foundation, used extensively in Europe for over 40 years, replaces a deeper, more costly foundation typically found in the U.S. In addition to saving construction and energy costs, insulated shallow foundations allow the placement of homes closer to the ground, eliminating the need for entrance steps that are a barrier for those with mobility problems. Floor plans incorporate other Universal Design features to make the home more comfortable and accessible for older residents and people with certain physical disabilities — extra-wide doorways and halls, no steps from attached garage into the home, wide accessible bathroom with optional roll-in shower, and large kitchen. The energy-efficient units have annual heating costs estimated at under \$200.

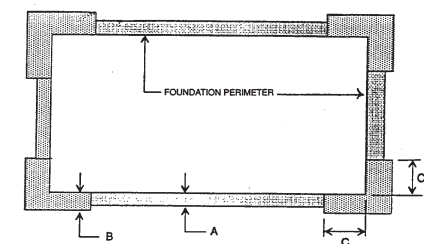
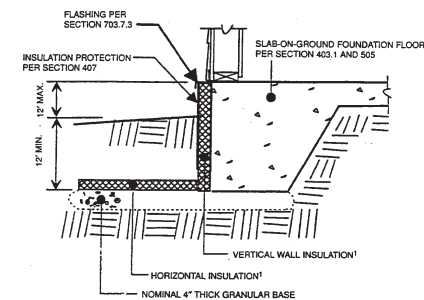

PROJECT PROFILE

Housing Type

Single-family townhouses on a suburban site.

Technology and Design

Insulated shallow foundation system saves construction cost and contributes to a barrier-free environment. Houses include other Universal Design features.

Project Size

35 units, ranging from 980 to 1,700 square feet.

Housing Price

Average price of a unit if \$80,270; 50 percent of reported median.

Financing

Conventional mortgages, with no government subsidy or support.

PROJECT CREDITS

Eid-Co. Buildings, Inc., Gerald D. Eid (*president*).

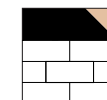

Additional Technology Information

NAHB Research Center
400 Prince George's Blvd.
Upper Marlboro, MD 20774
800-638-8556 (phone)

Additional Project Information

Eid-Co. Buildings, Inc.
1701 32nd Avenue South
Fargo, ND 58103
701-237-0510 (phone); 701-239-4702 (fax)

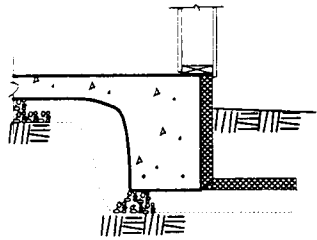

FPSF

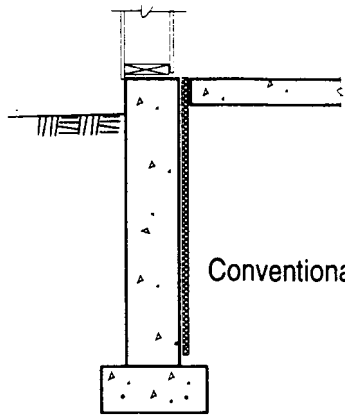

Conventional

Insulated shallow foundations are used to cut construction costs and to eliminate physical barriers into the home for those with mobility impairments. Improved insulation levels contribute to energy efficiency.



EPHESIAN HOMES

Buffalo, New York

The Ephesian Homes project is a union between an architect with a successful “infill” housing design, a supplier of quality modular building products, and a Buffalo minority contractor with a plan to create jobs for the community’s unemployed while producing homes. Ephesian Homes is a variation on an original compact “infill house” designed to fit Buffalo’s narrow vacant lots. Exterior walls will be constructed of Sparlock, a concrete block, interlocking, mortarless, modular product that is easily installed by unskilled labor. The greater fire resistance of the masonry material compared to typical wood frame materials allows placement of homes on the lot-line, leaving space for a private driveway not often feasible on inner city properties. Exterior walls are clad with Novabrik panels—a mortarless concrete siding system. Plans are to manufacture Sparlock blocks in factories in one of Buffalo’s Urban Revitalization Zones, thus spurring local job creation.



PROJECT PROFILE

Housing Type

Single-family houses on urban infill sites.

Technology and Design

Houses constructed of a modular concrete masonry units system that is mortarless and can be built by unskilled labor. Exterior cladding is a mortarless concrete siding system. The houses are designed to fit into 30-foot-wide lots.

Project Size

Two model units, averaging 1,300 square feet.

Housing Price

Units are offered for an average of \$94,000; 92 percent of reported median.

Financing

Conventional mortgages.

PROJECT CREDITS

George Nicholas of Nicholas Enterprises/Victor Libertore of Libertore Enterprises, (*building contractors*);
Stievater + Associates: Architects (*architects*);
Riefler-Sheehen Group, L.L.C. (*modular building products supplier*);
Jocelyn Bos, Inc. (*independent housing consultant*).

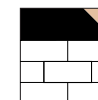

Additional Technology and Project Information

George Nicholas and Victor Libertore
395 East Ferry Street
Buffalo, NY 14208
716-836-6187 (phone); 716-759-0336 (fax)

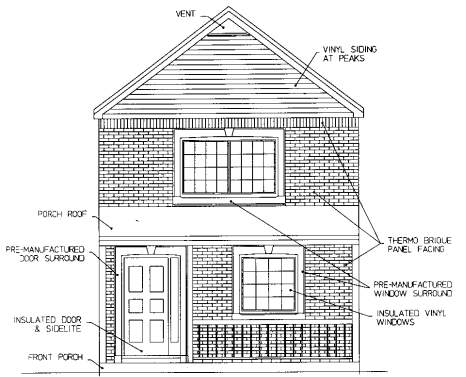
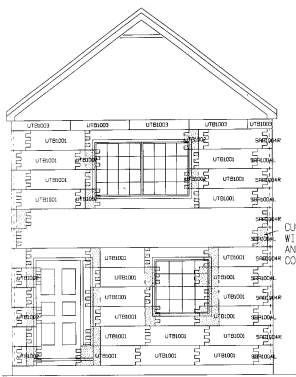
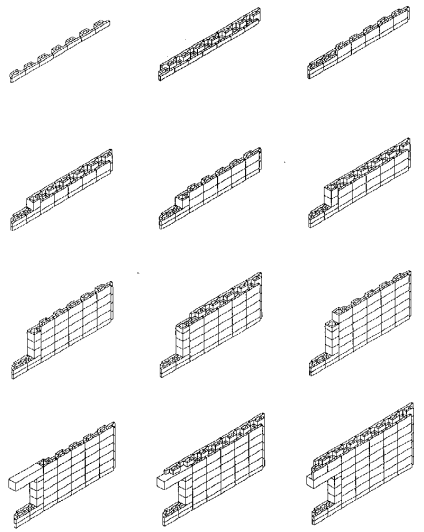

Project uses interlocking concrete block design to make construction easier and accomplished with unskilled labor, thus cutting costs. Concrete siding is used.

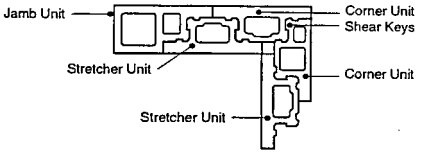

PARK WEST

Palmetto, Florida

These houses are constructed with a patented design system using insulated concrete form (ICF) construction technology. The walls consist of 4x8 foot panels of flame-retardant expanded polystyrene, 9³/₈ inches thick. They are cored vertically and horizontally to form posts and beams in a monolithic system of reinforced concrete post and beam construction. The panels are erected on-site, braced, and then filled with 5,000-psi concrete to produce an extremely strong wall with a stated R-40 insulation value. The roof uses engineered wood I-beams as rafters, with 9-inch EPS rigid insulation between the rafters. The foam insulation is supported by the rafter flange, speeding construction and providing a stated R-50 roof insulation. A radiant barrier is applied to decrease the air conditioning load. Average construction time is from 5 to 9 days. The homes are extremely energy-efficient, with about one-half the air conditioning and heating requirements of conventionally constructed units. A whole house ventilating fan cools the homes inexpensively in off seasons. For further comfort, each room is pre-wired for a ceiling fan. All conditioned air is cleaned electrostatically.



PROJECT PROFILE

Housing Type

Attached duplex units.

Technology and Design

Insulating concrete form construction technology with enhanced energy conservation.

Project Size

10 units, with 1,400 square feet.

Housing Price

Units average \$65,000; 72 percent of reported median.

Financing

Buyer financial assistance available from public agency.

PROJECT CREDITS

Palmetto Homes (*builder*);
Amhome USA, Inc. (*manufacturer*);
**Manatee County Community
Redevelopment Agency** (*buyer
financing assistance*).

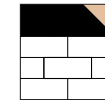

Additional Technology and Project Information

Amhome USA, Inc.
P.O. Box 1492
Land O'Lakes, FL 34639
800-393-3626 (phone); 813-996-5452 (fax)



Insulated concrete form construction with panels promotes ease of construction and better energy performance. Roofs are of rigid insulation and deliver superior R-values.

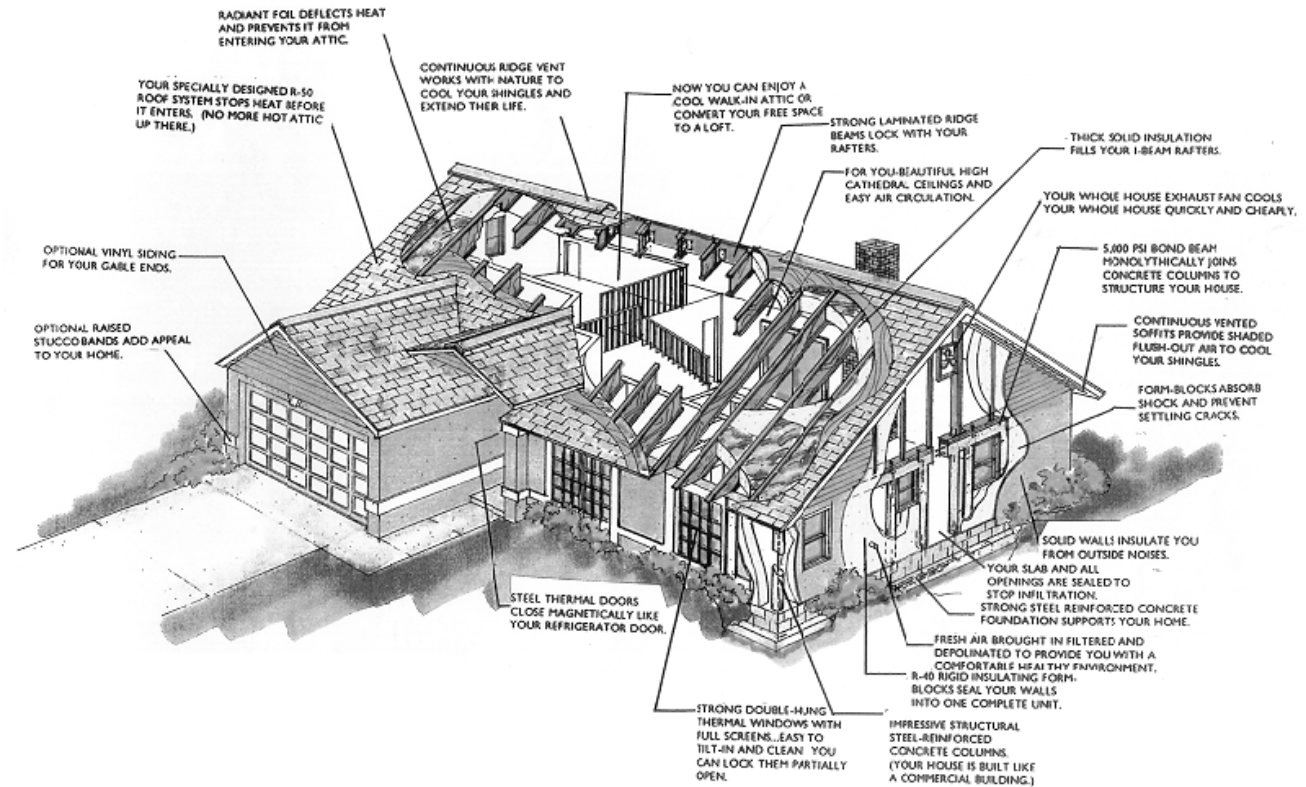

HABITAT FOR HUMANITY-WALTON COUNTY

Freeport, Florida

The innovative Hebel Aerated Concrete block used to construct these homes was first developed in Europe by Hebel over 50 years ago and has been used to build over 1 million homes around the world. However, it is still relatively new in the U.S. The technology is both practical and volunteer-friendly, making it a model for other Habitat projects in the U.S. and abroad. The blocks weigh 25 percent less than conventional concrete masonry units (CMU). The material is a mixture of sand, cement, lime, water, and a proprietary expanding agent. When the mixture is cured in an autoclave using high pressure steam, the expanding agent creates millions of tiny air pockets in the material. The air pockets make the material energy efficient—an 8-inch wall panel outperforms a typical stud wall system with R-30 insulation, significantly reducing energy costs. The material is 20 percent the weight of conventional concrete, making it easy to work with. The inorganic material is impervious to termites and other pests and fire resistant. The blocks can also be cut, drilled, and nailed using standard wood tools. The material comes in blocks, jumbo blocks, stair systems and wall, ceiling, floor, and roof panels.



Hebel blocks are light-weight and easy to cut and move into position. Construction can be accomplished by those with minimal skill levels. Material is also naturally insulated, boosting energy performance.

PROJECT PROFILE

Housing Type

Single-family detached units.

Technology and Design

Innovative aerated concrete that is light-weight, easy to work with, and versatile. Can be used to construct houses in virtually any design.

Project Size

2 to 6 units, at 1,170 square feet.

Housing Price

Units offered at \$40,000; 48 percent of reported median.

Financing

Houses developed by non-profit group; sweat equity helps make housing affordable.

PROJECT CREDITS

Habitat for Humanity-Walton County (builder);

Habitat for Humanity International (builder);

Hebel House USA, (architect, co-builder).

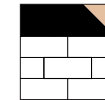

Additional Technology Information

Hebel House USA
4400 Highway 20 East, Suite 209
Niceville, FL 32578
904-897-7147 (phone); 904-897-7148 (fax)

Additional Project Information

Habitat For Humanity-Walton County
P.O. Box 2400
Santa Rosa Beach, FL 32459
904-231-1686 (phone)



9. SUSTAINABLE DESIGN AND CONSTRUCTION

In just the past few years sustainable design and construction has received more attention by the homebuilding industry. Sustainability seeks to address the diminishing of natural resources and to limit the environmental impact of development. Some techniques include: the use of recycled-content building materials; materials with low environmental impact (such as straw bales); finishes, materials, and furnishings with low volatile organic compounds (VOCs) for better indoor air quality; synthetic materials to replace those from diminishing sources; materials, finishes, and furnishings that exert a minimal impact on the environment in their fabrication and distribution; materials that can be easily removed and recycled at the end of the building's useful life; materials with no ozone-depleting chlorofluorocarbons (CFCs) or hydrochlorofluorocarbons (HCFCs); site water run-off management to decrease dependence on existing infrastructure; water-conserving plumbing fixtures; recycled gray water for site irrigation; construction waste management and recycling. Sustainable design and construction techniques can result in housing with lower maintenance costs, better indoor air quality, and less environmental impact.

Straw-Bale Housing	140
Greenlee Park	144
Rosebud Reservation	146
Tamarack Point	148
Colonia Muniz	150
Oak Ridge	152
Habitat GreenHOME	154

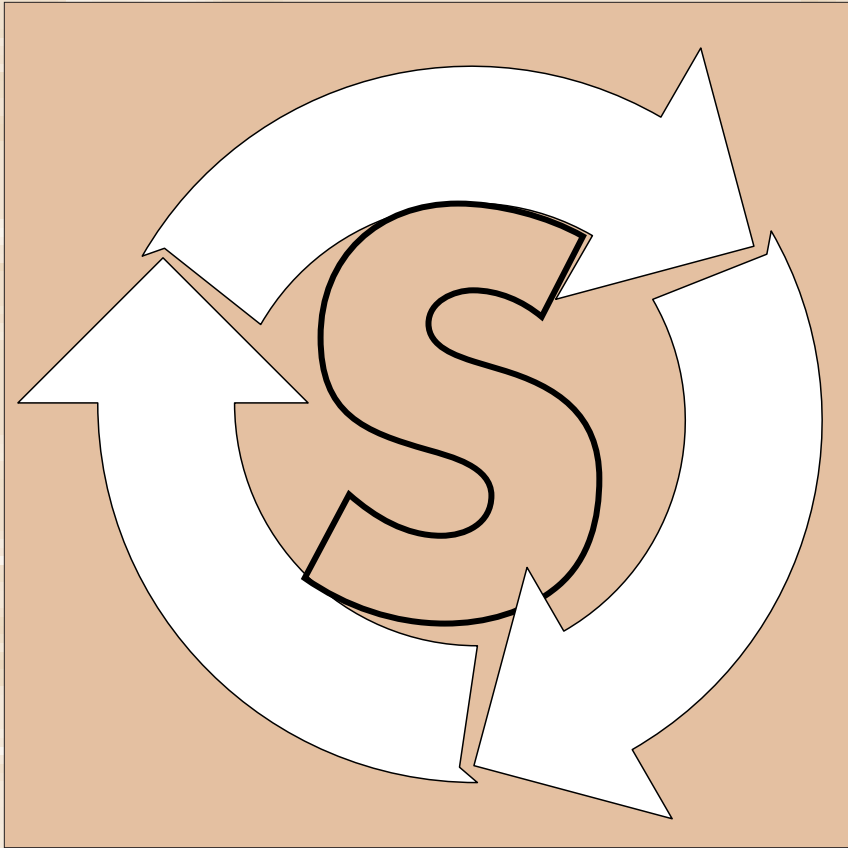

SUPER-INSULATED STRAW BALE HOUSING

Tucson, Arizona

The first 2 of 18 single-family homes have been constructed on city-owned sites by Habitat for Humanity Tucson and the Tucson Urban League. Site and house plans were developed through a participatory process led by the City of Tucson and the Development Center for Appropriate Technology and included staff from various city departments, design and building professionals, neighbors, potential homeowners, and interested citizens. The final designs couple straw bale construction with solar and other energy conserving technologies to create homes that are more energy efficient and affordable. The straw bale walls covered with thick stucco inside and out provide an insulation value of R-55. Blown cellulose will insulate the ceiling to R-38. South-facing windows allow the winter sun to heat the polished concrete floors, radiating heat at night. Window placement for cross-ventilation, window shades, and landscaping for shading provide further comfort. Water will be heated by solar batch water heaters. The homes are available for families earning less than 50 percent of median income who complete homeownership and self-sufficiency training and contribute sweat equity.



PROJECT PROFILE

Housing Type

Scattered site, detached single-family.

Technology and Design

Sustainable straw-bale wall construction delivers high insulation for superior energy performance, in combination with passive solar design features.

Project Size

18 units, ranging from 1,100 to 1,200 square feet.

Housing Price

Units average \$45,000 on city-owned sites; 34% of reported median.

Financing

Owners' \$5,000 sweat equity, low-interest mortgages from city, homeownership training from city urban league.

PROJECT CREDITS

City of Tucson, Community Services Department Technical Services Division, Department of Transportation, Planning Department; Janet Marcus and Molly McKasson (*City Council members*)

Development Center for Appropriate Technology (DCAT), David Eisenberg, executive director, (*project consultant*);

Out On Bale (*project consultant*);

Habitat for Humanity Tucson (*builder/developer*);

Tucson Urban League (*builder/developer*).



Additional Technology Information

Out On Bale
1039 East Linden Street
Tucson, AZ 85719
502-624-1673 (phone); 502-299-9099 (fax)
e-mail: outonbale@aol.com

Additional Project Information

Development Center for Appropriate Technology
P.O. Box 41144
Tucson, AZ 85717
520-624-6628 (phone/fax)
e-mail: strawnet@aol.com

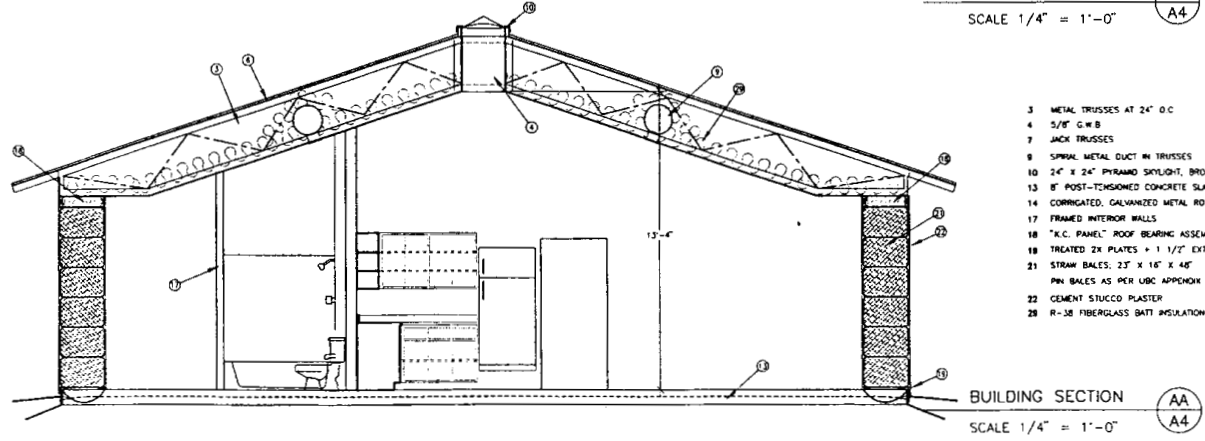
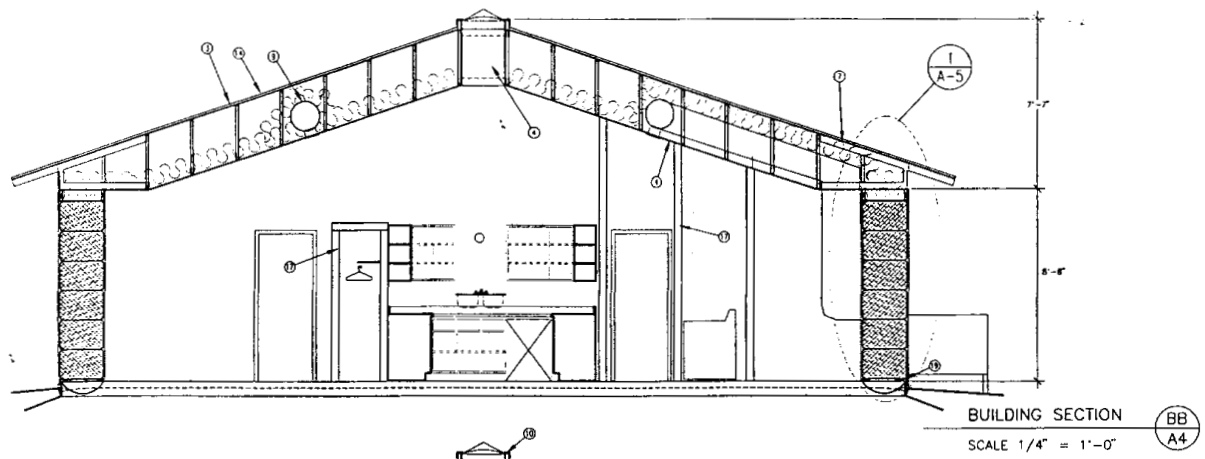

- 3 METAL TRUSSES AT 24" O.C.
- 4 5/8" C.W.B.
- 7 JACK TRUSSES
- 8 SPIRAL METAL DUCT IN TRUSSES
- 10 24" X 24" PYRAMID SKYLIGHT, BRONZE OVER WHITE
- 13 8" POST-TENSIONED CONCRETE SLAB
- 14 CORRUGATED, GALVANIZED METAL ROOFING
- 17 FRAMED INTERIOR WALLS
- 18 "K.C. PANEL" ROOF BEARING ASSEMBLY
- 19 TREATED 2X PLATES + 1 1/2" EXTRUDED POLYSTYRENE
- 21 STRAW BALES, 23" X 16" X 48"
- 22 CEMENT STUCCO PLASTER
- 28 R-38 FIBERGLASS BATT INSULATION



Straw-bale wall construction achieves significant insulation levels through density of organic material. Bales are easily assembled on site and require minimal building skills.



Straw-bale construction can easily accommodate door and window openings. Steel-framing is used for roof structure. With bales in place, stucco finish is applied inside and out for added insulation.

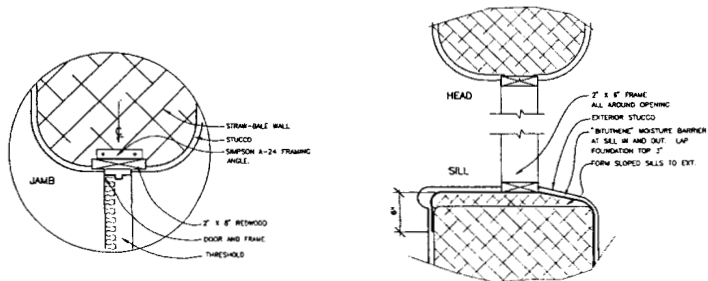
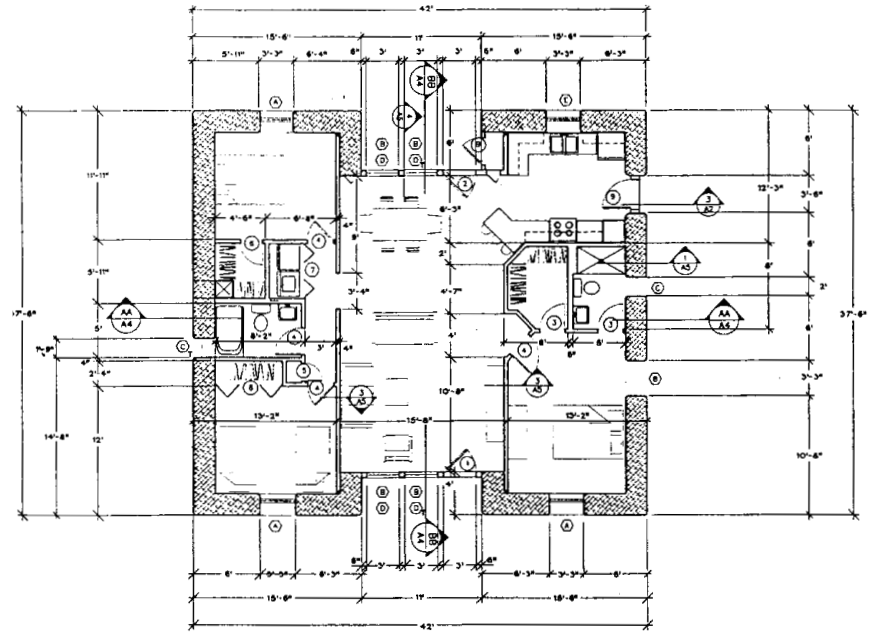

GREENLEE PARK AT INDIAN PEAKS

Lafayette, Colorado

Described as an “environmental community,” Greenlee Park is a development of 168 units, including 35 detached single-family houses, 44 duplex units, and 89 townhouses. The density on the 22-acre site is 7.5 units per acre, allowing ample open space to be preserved and using natural vegetation as buffers between the units and the surrounding development. Open spaces are connected by pedestrian pathways. This for-profit development uses no subsidies. The houses are designed with several “sustainable” or “green” features such as engineered wood structural elements, finger-jointed studs, recycled content materials such as oriented strandboard sheathing and hardboard siding, recycled wood and plastic decking, low VOC paints, recycled content carpeting and cellulose insulation, and compact fluorescent lights. Energy conservation features include low-e argon-filled window glazing, set-back thermostats, and a heat recovery system that captures heat from the domestic hot water heater, which allows homes to be heated without furnaces.

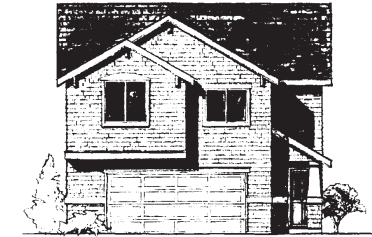

PROJECT PROFILE

Housing Type

Detached single-family houses, duplex units, and townhouses on land held in common.

Technology and Design

Emphasis on sustainable design, materials, and site development. Energy-efficient features and HVAC systems.

Project Size

168 units, single-family houses average 1,400 square feet; duplexes average 1,130 square feet; townhouses average 1,300 square feet.

Housing Price

Units average \$139,070; 70 percent of reported median.

Financing

For-profit development with no subsidies.

PROJECT CREDITS

McStain Enterprises (*developer and builder*).



Additional Technology and Project Information

McStain Enterprises, Inc.
75 Manhattan Drive, Suite 1
Boulder, CO 80303
303-494-5900 (phone)



Greenlee Park incorporates a number of sustainable features in a conventional-appearing community. Cluster housing allows green areas to buffer development. Low-VOC finishes are used throughout interior to promote good indoor-air quality.



ROSEBUD RESERVATION “CORE” HOUSE

Mission, South Dakota

This project attempts to return the provision of affordable housing to Native Americans on the Rosebud Reservation. The reservation’s housing coalition engaged a team of collaborators to help design and construct affordable housing that is sustainable, energy efficient, and reflects the beliefs and traditions of this native people. Design workshops were conducted to examine the tradition of Lakota Sioux housing and how assistance could be made more responsive to the population. A design for the “core” house of 575 square feet was developed, which could be built for under \$11,000. The core could be enlarged over time as the family’s resources improved, and much of the construction would be self-help. A strategy to use materials from existing derelict housing reduces the cost of construction and enhances sustainability. Passive solar techniques are considered to improve energy performance. Other building technologies studied include rammed earth and straw bales. Norwest Bank has expressed its commitment to offer matching grants to aid construction material purchase, and there has also been support through the various members of the nonprofit housing coalition.



PROJECT PROFILE

Housing Type

Single-family detached houses on tribal lands.

Technology and Design

Core design allows expansion as the family grows; sustainable materials and construction techniques, included recycled and salvaged materials, rammed earth, straw bales, passive solar design strategies.

Project Size

7 units at 575 square feet.

Housing Price

Core house not to exceed \$11,000; 12 percent of reported median.

Financing

Matching grants from Norwest Mortgage for construction materials; additional support from reservation housing authority and HUD.

PROJECT CREDITS

Sicangu Enterprise Center, Cheryl Crazy Bull (*executive director*), Mary Whiting (*assistant director*); **WRITAR**, Joel Schurke; **Center for Resourceful Building Technology**, Tracy Mumma, Steve Loken, Dale McCormick; **The University of Oklahoma**, College of Architecture, Katharine Leigh (*division director*), Thane Magelky and Antonio Cooper; **US Environmental Protection Agency Region 8** (David Wann); **Rosebud Housing Authority**, Monica Larvie, Ken Haukaast, Mike Schmidt; **American Indian Council for Architects and Engineers**, Burke Wyatt; **Norwest Bank South Dakota, N.A.**, Kermit Grimshaw.



Additional Technology and Project Information

Rosebud Housing Coalition
P.O. Box 205
Sicangu Lakota Nation
Mission, South Dakota 57555
605-856-2955 (phone); 605-856-4671 (fax)

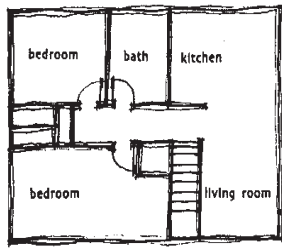

SPLIT LEVEL: no size

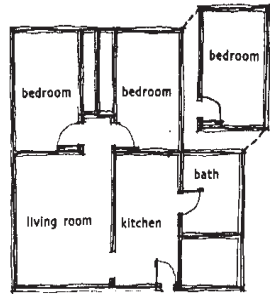
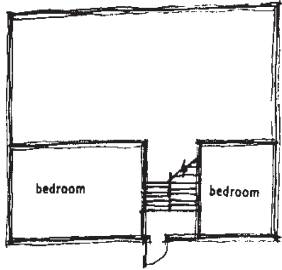

TIMBER FRAME: 28' x 32'

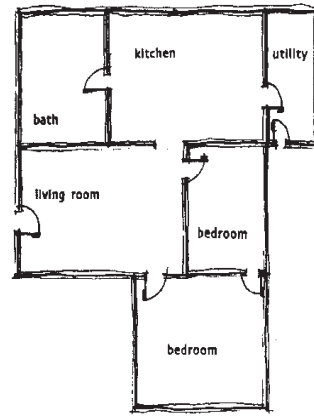

TIMBER FRAME: renovated with used materials

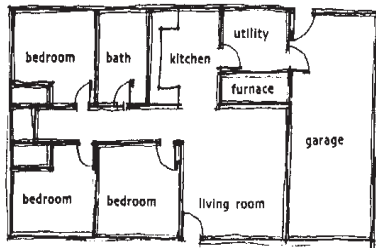

RANCH: no size

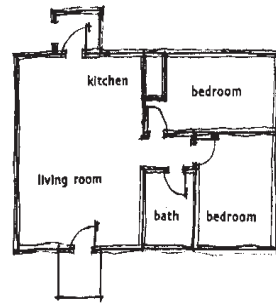

SIOUX 400: 22' x 36'

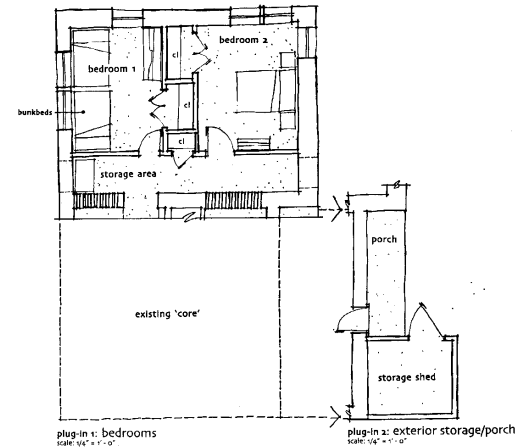
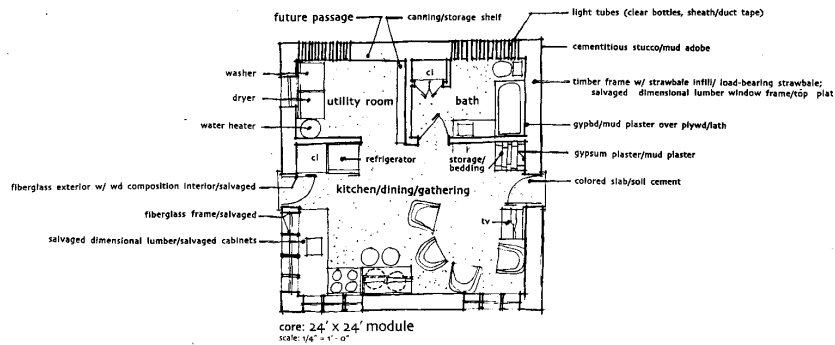

Materials recycled from existing Native American housing are used to construct core houses that can grow as the family expands. Construction is self-help, which helps to build skill levels.

TAMARACK POINT

Steamboat Springs, Colorado

Recognized as Colorado's first "E-Star Green Subdivision" by the State Office of Energy Conservation, this development offers three-bedroom homes for first-time homebuyers. The Green Program requires a mix of criteria regarding issues such as site design and impact, thermal envelopes, mechanical systems, indoor-air quality, water heating, appliances, lighting, structural framing, foundations, insulation, and water use. The homes combine passive solar architecture, super-insulation, gasketed air-tight drywall, heat-recovery ventilation, sealed combustion heating appliances, high-efficiency lighting, water-efficient fixtures, no-VOC paints, and remanufactured and recycled building products to produce a healthy, resource-efficient home. Heating costs of less than \$300 per year are guaranteed or the builder will pay the difference, not typical in this climate with a year-round average temperature of 38.9F and 9,523 heating degree-days per year. City staff assisted developers to plan a 40-foot right-of-way for a loop road through the development rather than the standard 60-foot. These deviations left room for a small central park. Xeriscape native landscaping appears throughout.



PROJECT PROFILE

Housing Type

Single-family detached units.

Technology and Design

Emphasis on energy conservation features and sustainable design and materials. Attention to green areas around development to maintain site features in their natural state.

Project Size

29 units, between 1,100 and 1,500 square feet.

Housing Price

Units offered from \$128,000; 79 percent of reported median.

Financing

Qualifies for energy efficient mortgages.

PROJECT CREDITS

Habitat Design & Construction

Co., (energy design and builder), Michael L. Roberts, president, Mark Palmer, director of Energy Services; **Hunter's Glen**, Jon Peddie, Principal (*developer*); **Rob Dick** (*developer*).



Additional Technology and Project Information

Habitat Design & Construction Co.
P.O. Box 775127
Steamboat Springs, CO 80477
970-879-5371 (phone); 970-879-0537 (fax)



Among the energy conservation features employed are improved insulation levels, gasketed air-tight drywall, and minimal site impact. Houses deliver superior performance and are sustainable.



COLONIA MUNIZ

Edinburg, Texas

Colonias are unincorporated U.S. rural subdivisions that lack physical infrastructure and decent housing. Appropriate technologies and development techniques are at the core of the La Frontera Initiative. These two components are not just tools for house building, but also for community building, allowing individuals, households, and organizations in colonias to take ownership of, and seek creative solutions to, their housing needs. Colonia Muniz homes offer buyers a small, decent, comfortable, healthy, low-cost, low-maintenance home. The homes have a white plaster exterior for greater solar reflectivity and are sited and designed to maximize natural ventilation to reduce the effects of the sun in this subtropical climate. Surface bonded, dry-stacked concrete block walls ensure durability, low maintenance, termite and fire resistance, and easy construction. The scored and stained concrete slab provides an inexpensive, functional floor surface. A solar water heater and rainwater catchment system are optional. East-west orientation allows for future installation of photovoltaic panels. There is also separate gray water/black water waste treatment for water reuse and cost savings.



PROJECT PROFILE

Housing Type

Single-family detached units.

Technology and Design

Emphasis on passive solar design strategies to keep the house comfortable in a hot climate. Sustainable features enhance water conservation. Building technologies are easy to use by novice builders.

Project Size

First phase: 3 units, at 760 square feet.

Housing Price

Units average \$15,000.

Financing

Houses developed by non-profit agency; 0 percent mortgages available; sweat equity helps make housing affordable.

PROJECT CREDITS

Habitat for Humanity International;
La Frontera Initiative;
Proyecto Fe y Esperanza, David Omick, (*house designer*);
ARISE, Inc.;
HFH-Exodus, first colonia-based Habitat affiliate in the country.

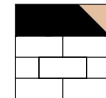

Additional Technology and Project Information

La Frontera Initiative
Habitat For Humanity International
1701 North Eighth Street A-18
McAllen, TX 78501
210-682-7277 (phone); 210-682-9351 (fax)



Sustainable features include plaster exteriors to promote good energy performance, rainwater catchment system, and solar water heating. New houses replace substandard accommodations.



OAK RIDGE VILLAGE

San Antonio, Texas

Oak Ridge Village includes a popular three-bedroom model selling for under \$100,000. Sixty-five additional developed lots are ready for construction. Medallion uses engineered wood products to increase housing quality and better utilize lumber supplies. Innovative materials include engineered wood I-beams and finger-jointed studs which join shorter wood pieces to create a higher-quality dimensional lumber product in long lengths. All Medallion Homes are built to the requirements of the Good Cents™ Environmental Home program which features energy efficiency and environmental considerations promoting conservation of natural resources (recycled materials) and better indoor air quality (low VOC paints and adhesives). This program allows homeowners to reduce closing costs, obtain lower interest mortgages, and increase the debt-to-income ratio. Xeriscape landscaping is featured in all of the homes, using indigenous plants to reduce water requirements as well as costs. Medallion has also introduced a Green for Green program with rebates available up to \$300 for additional landscaping installed by the homeowner within 4 months of closing.



PROJECT PROFILE

Housing Type

Single-family detached houses in a suburban development.

Technology and Design

Units incorporate a number of energy-saving strategies such as radiant barriers, increased insulation levels, natural ventilation; several sustainable features such as recycled materials.

Project Size

12 units averaging 1,692 square feet.

Housing Price

Units average \$97,000; 81 percent of reported median.

Financing

Assistance with closing costs, low down payment program, Energy Efficient Mortgage program.

PROJECT CREDITS

Medallion Homes Inc. (*builder*);
Good Cents™ Environmental Home.



Additional Technology and Project Information

Medallion Homes, Inc.
14607 San Pedro, Suite 100
San Antonio, TX 78232
210-494-0003 (phone); 210-494-8109 (fax)

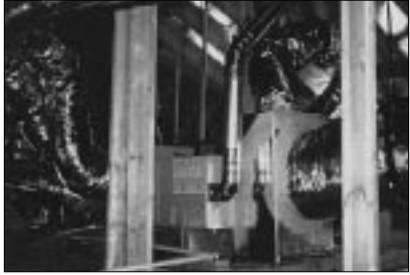

Emphasis is on recycled or recyclable construction materials, improved HVAC design, better insulation, and improved indoor air quality. Xeriscape landscaping is also a feature.

GreenHOME

Washington, DC

GreenHOME is developing two sustainable, energy efficient, and affordable three-bedroom homes on an urban in-fill site. Construction waste will be minimized by careful accounting and management of materials. An on-site recycling program will provide a simple method to store and reuse materials. Used products will be incorporated wherever possible. For example, units will use concrete rubble instead of mined gravel fill around the homes' foundations. Wood blocking, insulation, nails, and other small items from other Habitat sites will be reused. Vinyl siding, vinyl flooring, PVC piping, asphalt shingles, gypsum board, and carpeting that include recycled materials will be selected as is feasible. The GreenHOME units will have a passive cooling system, with a whole-house fan to ventilate both house and attic heat at night. An innovative combination gas furnace/domestic hot water heater will supplement winter sunlight coming in large southeast-facing windows. Insulation in the walls, roofs, and floors will be increased about 40 percent above the typical Habitat homes to maximize heating and cooling benefits and reduce cost.

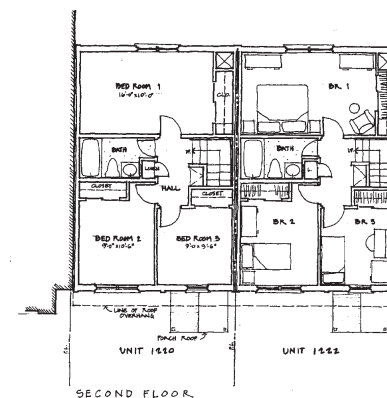

PROJECT PROFILE

Housing Type

Townhouses on urban infill site.

Technology and Design

Sustainable design, materials, and technologies to reduce impact on finite natural resources and enhance energy efficiency.

Project Size

2 units at 1,200 square feet.

Housing Price

Units average \$65,000; 33 percent of reported median.

Financing

Sweat equity and no-interest loans; monthly payments of no more than \$300; land donated by local real estate company.

PROJECT CREDITS

GreenHOME, Wes Blaney (*design chair and advisory board liaison*), Kim Schaefer (*co-director*); **D.C. Habitat for Humanity** (*developer*).



Additional Technology and Project Information

D.C. Habitat for Humanity
3304 Martha Custis Drive
Alexandria, VA 22302
703-820-7039 (phone); 703-820-3244 (fax)

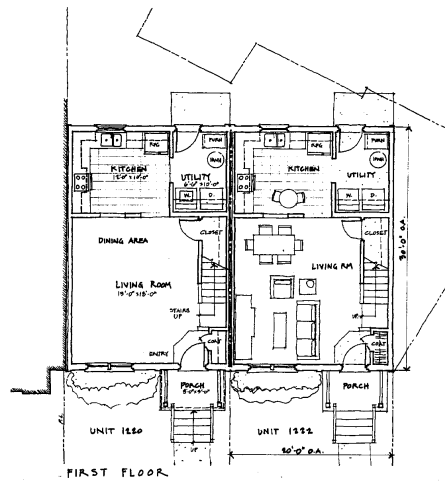

STREETSIDE VIEW

Construction waste is to be kept to a minimum in this urban development of sustainable homes, constructed by Habitat for Humanity. Products and materials with recycled content are also important to the project.



EXISTING HOUSES

NEW GreenHOME HOUSES

10. SITE DESIGN

Innovations in site design and development can lead to greater housing affordability in a number of different ways. On certain sites, for example, construction can be virtually impossible due to difficult terrain. Techniques of attaining a larger buildable area on the site can include regrading, filling, berming, or erecting retaining walls. Site development can also be limited due to the soil's capacity to absorb septic waste. In such cases, it may be possible to concentrate waste treatment in a certain area of the site with communal septic fields. Savings can also be realized in minimizing the impact of construction on the natural features of a site, such as planning house placement in and around existing trees, which eliminates the need for removal. Such a technique also enhances the value of the property by preserving as much greenery as possible. Traditional planning principles—emphasizing pedestrian pathways, greater housing densities, shared public spaces, and smaller, easily maintained lots—can result in more vibrant community life and lower infrastructure costs.

Los Abinicos	158
Field of Dreams	160
Grove at Patuxent Woods . .	162
Coliseum Oaks	164
TreeHouse in the Woods . .	166
Braun Court	168
Jingle Town	170
Citrus View Homes	174
Garden Cottages	176

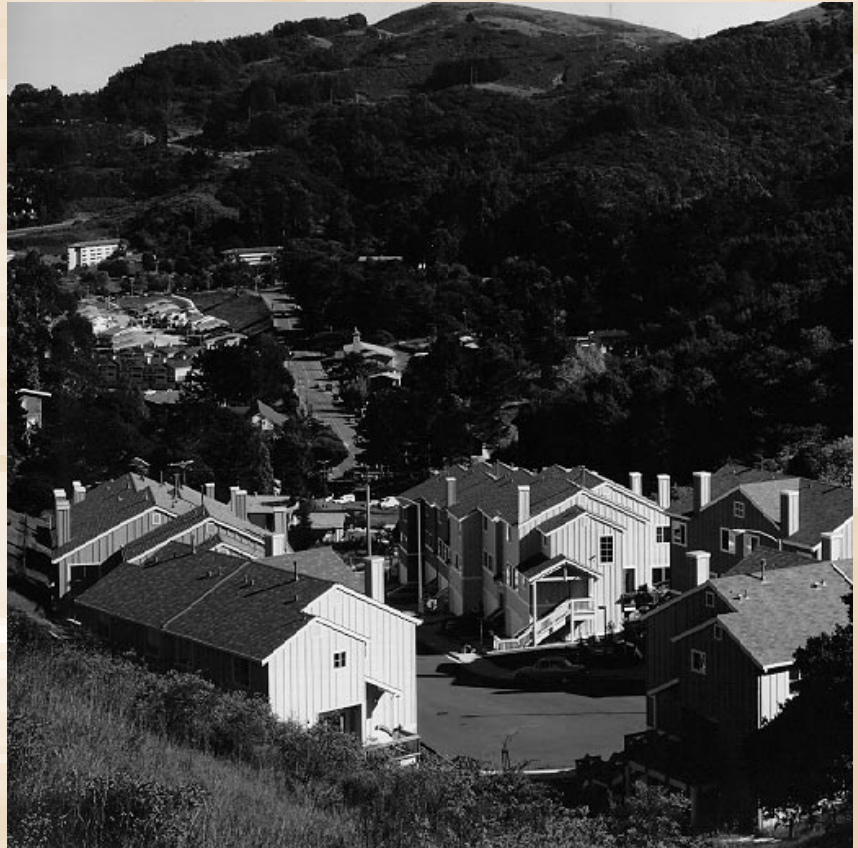
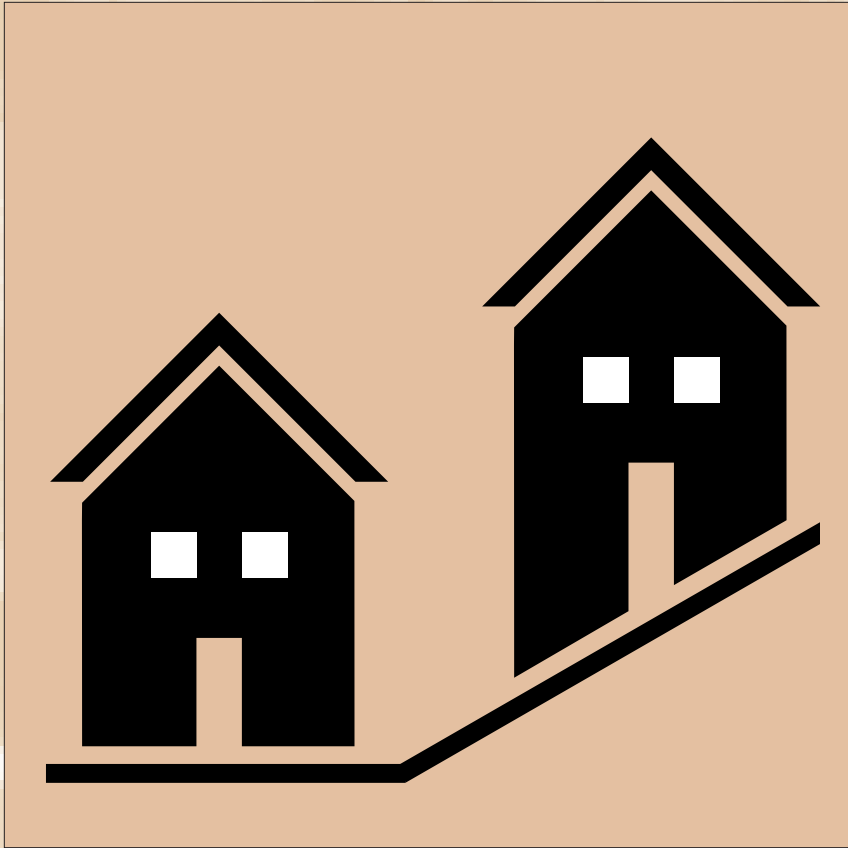

LOS ABINICOS

Rancho Santa Margarita, California

This suburban-type development is innovative in its use of a combination of technologies to value-engineer construction, boost energy efficiency, and reduce operating costs. Also distinctive is the shared open-space design, which saved costs in site and infrastructure development. The prices of the Los Abinicos homes represents a savings of \$7,000 to \$9,000 over comparable affordable new housing construction in this region. The clustered site-plan design of eight houses around a shared courtyard space makes efficient use of the land, achieving more than 14 units per acre. The units themselves incorporate steel open-web joists, which is a saving on material and allows utilities runs to be easily accomplished; value-engineered framing techniques; higher insulation levels; lower air infiltration; glass with higher shading coefficients; and smaller mechanical systems housed in attic spaces to reduce duct runs. Bulk purchase of amenity items in the units lowered construction costs and simplified financing. The energy-saving techniques should result in a 38 percent savings in operating costs, allowing the houses to qualify for FAA/VA mortgages with lower down payments.

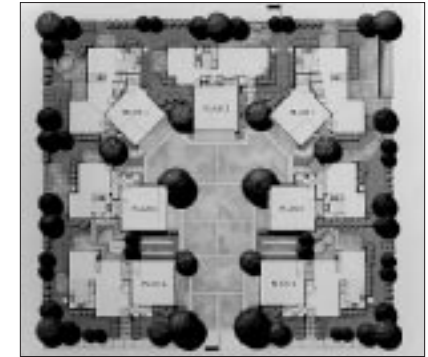

PROJECT PROFILE

Housing Type

Single-family attached houses in cluster development.

Technology and Design

Clustered development saves on land and infrastructure costs; variety of energy-saving technologies and optimized construction practices.

Project Size

180 units between 874 and 1,474 square feet.

Housing Price

Units start at \$126,900; 87 percent of reported median.

Financing

Low closing costs; mortgages at below market interest rates; “interest rebates” applied to down payment or closing costs; interest rate buydowns and subsidies.

PROJECT CREDITS

RGC Corporation (*builder*), Jim Murar (*chairman*), Hal Lynch (*president*), Mike Kosulandich (*vice president purchasing*);

K. Young Homes, Inc. (*developer*); **IBACOS, Inc.**, Michael Dickens (*chief executive office*), Bradley Oberg (*director, technology*), Al Sain (*director, engineering*);

Burt Hill Kosar Rittelmann Associates, John Holton (*senior associate*).



Additional Technology and Project Information

IBACOS Inc.
2214 Liberty Ave.
Pittsburgh, PA 15222
412-765-3664 (phone); 412-765-3738 (fax)

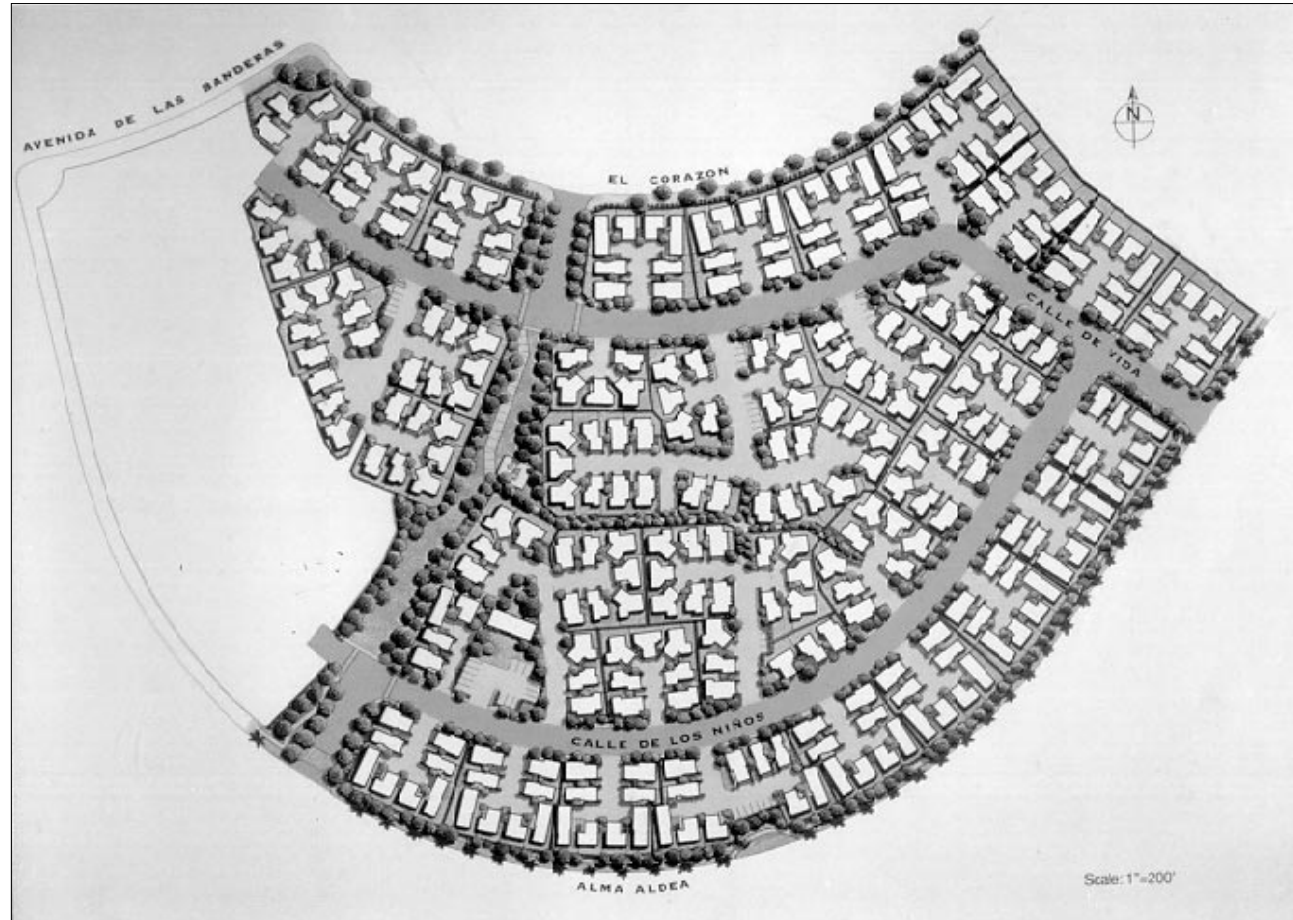

A cluster arrangement to this site plan economizes on land use and infrastructure, while giving the homes a small-scale community focus. Conventional stick-built construction is combined with energy-saving technologies.

FIELD OF DREAMS

Eugene, Oregon

Developed around a baseball field, the Field of Dreams neighborhood includes 44 houses designed on compact lots that encourage the sense of a close-knit community. The houses are simple in plan, with generous porches. They are constructed of light-weight prefabricated roof trusses, engineered wood floor joists, and low-maintenance materials. Passive solar strategies include large windows to admit natural light and site planning that orients units to take advantage of southern exposures. North-facing walls have minimal fenestration. The houses not only meet the stringent Oregon Energy Code but qualify for the local utility’s “Super Good Cents” incentive program, which mandates higher levels of energy performance and allows a \$2,000 credit for each house. Low-income units, offered from \$54,400 to \$71,200, utilize a rent-to-own strategy that allows a portion of monthly rent to be counted towards a down payment. A range of public, private, and non-profit entities provided grants and subsidies to lower housing prices.

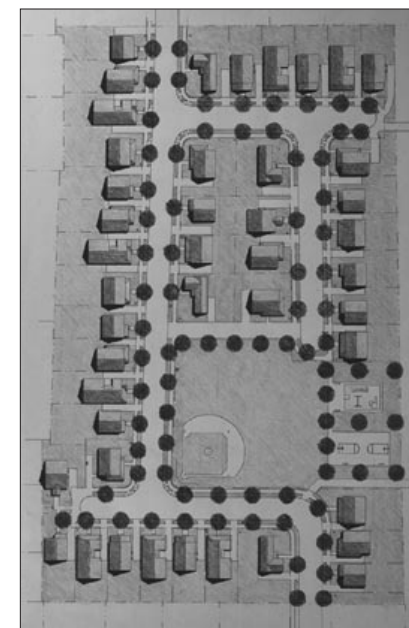

PROJECT PROFILE

Housing Type

Detached single-family units on compact lots.

Technology and Design

Emphasis on community development planning, with small lots focused around open space held in common. Units utilize prefabricated, low-maintenance materials and passive solar design strategies to enhance energy performance.

Project Size

44 units, between 768 and 1,440 square feet.

Housing Price

Units ranging from \$54,000 to \$89,900; 56 percent to 93 percent of reported median.

Financing

Public, private, and nonprofit support in the form of grants and subsidies.

PROJECT CREDITS

Neighborhood Economic

Development Corp. (NEDCO), John Hubbard, executive director (*developer and builder*);

Center for Housing Innovation,

Department of Architecture, University of Oregon, Peter Keyes, Jonathan Stafford, AIA (*design*).



Additional Technology and Project Information

Peter Keyes
301 SW Lincoln, Suite 1315
Portland, OR 97201
503-796-9376



The Field of Dreams development orients houses around a baseball field, giving the community a focus. Houses are on small lots and of traditional design, with porches and durable, low-maintenance exterior materials.

THE GROVE AT PATUXENT WOODS

Patuxent City, Maryland

This competition-winning design for small development in rural Maryland contains seven houses on land that was previously considered unbuildable. Percolation tests revealed that the soil conditions could not support development. However, through innovative site and infrastructure design, it was possible to concentrate large septic fields in areas of the site with adequate soil conditions, allowing four houses to route their septic to a fifth lot, while two other houses shared a septic field. The houses also contain other innovations. Pressure-treated permanent wood foundations were used on the houses to minimize site disturbance and to eliminate the added cost of concrete work. Using NAHB's *Cost-Effective Home Building*, framing was value-engineered so that it would use less material. The houses will be heated with geothermal heat pumps, a system that uses the earth's steady underground temperature to reduce utility bills. The local utility company will provide a rebate to lower the cost of the geothermal system. The houses are also designed and oriented on-site to benefit from passive solar strategies.



PROJECT PROFILE

Housing Type

Detached houses on a rural site.

Technology and Design

Shared septic systems. Houses constructed with permanent wood foundations, optimum value engineered construction, and heated with geothermal heat pumps.

Project Size

Seven units ranging from 815 to 1,140 square feet.

Housing Price

Units offered for an average of \$72,500; 45 percent of reported median.

Financing

Developed by a non-profit county housing provider, assisted with state and federal mortgage program and a rural development grant.

PROJECT CREDITS

Southern Maryland Tri-County Community Action Committee, Inc. (*builder/developer*);

Bennett Frank McCarthy Architects, Inc. (*architect/planner*), Ralph Bennett, Larry Frank (*project architects*);

Mark Ferguson, RDA (*civil engineer*);

Ambrish Rastogi, AJ Engineers (*mechanical engineer*);

MNC Mortgage, Inc. (*lender*), Ron Davis (*vice president*);

Charles County Commissioners (*local government*);

Charles County Department of Community Services;

Maryland Department of Housing and Community Development,

Patricia Payne (*secretary*).



Additional Technology and Project Information

Bennett Frank McCarthy Architects, Inc.
7003 Carroll Avenue
Takoma Park, MD 20912
301-270-9480 (phone); 301-270-9483 (fax)

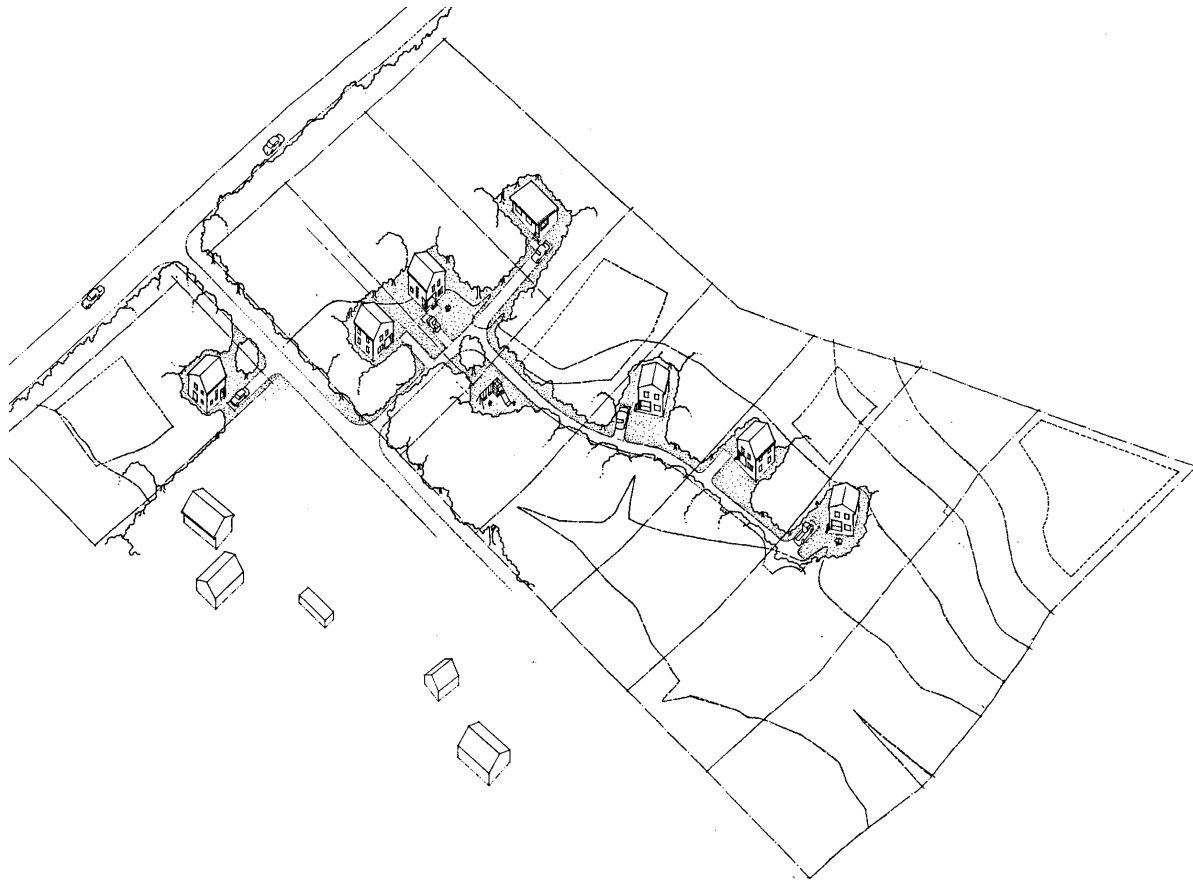

Asphalt Shingles on 15# Felt on Span-Rated Roof Sheathing on Pre-engineered Roof Truss

Aluminum Gutter, Vinyl-wrapped Fascia, Vinyl Ventilating Soffit

Single 2x4 Top Plate on 2x4 Studs (Optimum Value Engineered Framing System)

Beveled Vinyl Siding over 5/8" Rigid Insulating Sheathing

R-13 Batt Insulation with 1/2" Gypsum Wall Board

Wood Base
Carpet and Pad

Floor Joist with Span Rated Floor Sheathing, R-30 Batt Insulation

Single 2x4 or 2x6 Pressure Treated Top Plate, 2x4 Pressure Treated Stud Wall with Pressure Treated 3/4" Plywood Sheathing (Optimum Value Engineered Framing System) for All Weather Wood Foundation System

Finished Grade, Polyethylene Film on Crawspace Floor

Single 2x4 or 2x6 Pressure Treated Bottom Plate on 2x8 Pressure Treated Footing Plate on Gravel or Crushed Stone



Clustering the houses on this site, and allowing properties to share septic fields, permitted development of this poorly draining land. Construction includes wood foundations and value-engineered wood framing.



COLISEUM OAKS

San Antonio, Texas

Coliseum Oaks is a new neighborhood of single-family homes, created to provide a safe, attractive community on San Antonio's east side. Constructed on lots donated by the city, Coliseum Oaks has transformed a derelict site into a new neighborhood. The partners who made this project happen—including the Greater San Antonio Builders Association, the city, the nonprofit Christ is Our Savior Foundation (COSF), and others—worked together to assemble land, build the homes within three months, arrange for financing, and present the results in a three-day “Parade of Homes” that attracted more than 1,000 visitors who viewed 16 first-phase homes priced from \$38,500 to \$60,000. Forty-five of the 59 homes planned for the community have been built. Working together, a variety of local builders constructed single-family houses with a range of technologies: modular, steel studs, concrete-reinforced insulation, fiber-cement siding. A home using foam insulation with concrete reinforcement was able to achieve R-45 walls and ceilings. A range of support for Coliseum Oaks included the city's donation of foreclosed sites, a subsidy by COSF, interest-free mortgages, and HUD funding.



PROJECT PROFILE

Housing Type

Single-family detached houses in a revitalized neighborhood constructed on rehabilitated lots donated by the city. Site plan juxtaposes different construction technologies.

Technology and Design

A variety of technologies on adjacent sites in a distressed neighborhood.

Project Size

45 units averaging 1,200 square feet.

Housing Price

Units average \$50,000; 41 percent of reported median.

Financing

Units received \$20,000 subsidy from nonprofit foundation; interest-free, 20-year mortgages available; HUD Community Development Block Grants.

PROJECT CREDITS

Greater San Antonio Builders Association (*project management*);
City of San Antonio (*developer*);
San Antonio Housing Trust;
US Department of Housing and Urban Development (*San Antonio office*);
Fannie Mae;
San Antonio Board of Realtors;
Christ is Our Salvation Foundation (*nonprofit*);
Coliseum/Willow Park Neighborhood Association;
San Antonio Mortgage Bankers Association.



Additional Technology and Project Information

Greater San Antonio Builder Association
8925 IH 10 West
San Antonio, TX 78230
210-696-3800 (phone); 210-696-3810 (fax)



Vacant and abandoned properties in this San Antonio neighborhood were developed together under an agreement with the city. Houses of various construction technologies were developed on adjacent lots so that prospective buyers could compare them.



TREEHOUSE IN THE WOODS

Round Lake, Illinois

TreeHouse in the Woods is an entry-level community of townhomes on 20 heavily wooded acres. Its design combines environmental sensitivity and energy efficiency to develop and build this below median-priced community, five blocks from the METRA commuter train to Chicago and walking distance from community services. Over 80 percent of the 400 mature trees on the site were preserved through creative site planning and deliberate conservation during construction. Homes face landscaped courtyards with gazebos, trellised entries, and walking paths. Garages and driveways at the rear of the homes are accessed from motor courts. The project uses the same techniques of energy-efficient construction as the Harambee Homes (page TK). Heating costs for 3 years are guaranteed not to exceed \$200 for the heating season or the builder will pay the difference. Features include 2 x 6 and optimum value engineered (OVE) framing techniques to reduce lumber costs and increase insulation space; R-25 wall and R-38 attic and floor insulation; combination high-efficiency water/space heater; florescent hall and bath fixtures and exterior photocells; air sealing; and continuous bath ventilation.

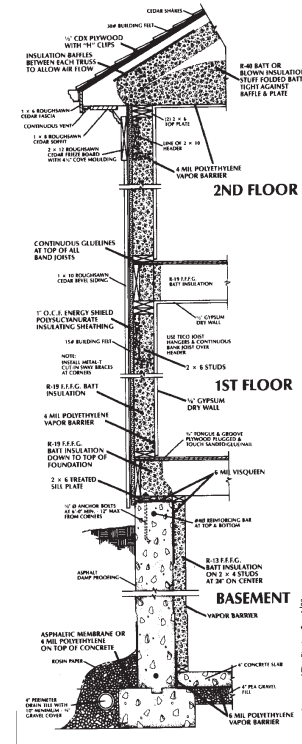

PROJECT PROFILE

Housing Type

Single-family townhouses on a heavily wooded site.

Technology and Design

Site planning is neo-traditional and disturbs as little of the existing landscape as possible. Units incorporate a number of energy-efficient features such as boosted insulation, extensive caulking, value-engineered framing, improved indoor air quality.

Project Size

220 units ranging from 800 to 1,530 square feet.

Housing Price

Units range from \$99,900 to \$135,900; 53 to 79 percent of reported median.

Financing

First-time homebuyer assistance program available.

PROJECT CREDITS

The Bigelow Group (*builder/developer*), Perry Bigelow (*president*); **Midland Landscape**, Harold (Hank) Bauer; **Midwest Forestree Products**, Dana Stillson; **Lenet Design**, Steve Lenet (*landscape architect and land planner*); **Urban Forest Management**, Charles Stewart; **Henderson and Bodwell**, Paul Ulatowski (*civil engineer and partner*); **Village of Round Lake**, James Lumber (*mayor*).

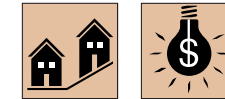

Additional Technology and Project Information

The Bigelow Group
999 South Plum Grove Road
Palatine, IL 60067
847-705-6400 (phone); 847-705-6733 (fax)

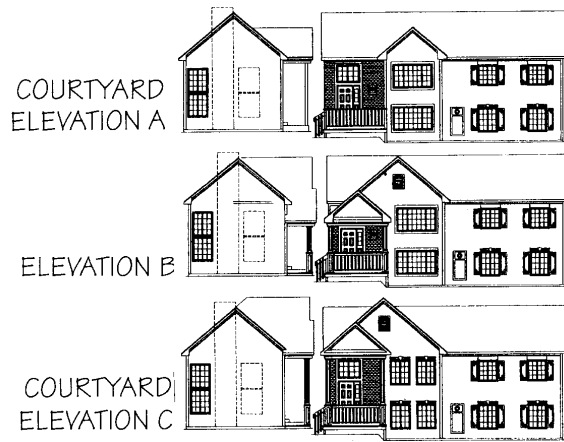

Sensitive land planning preserved trees, other natural vegetation, and topographic features, with houses sited in and around them. Energy-efficient construction was used to improve performance and to cut operational costs.

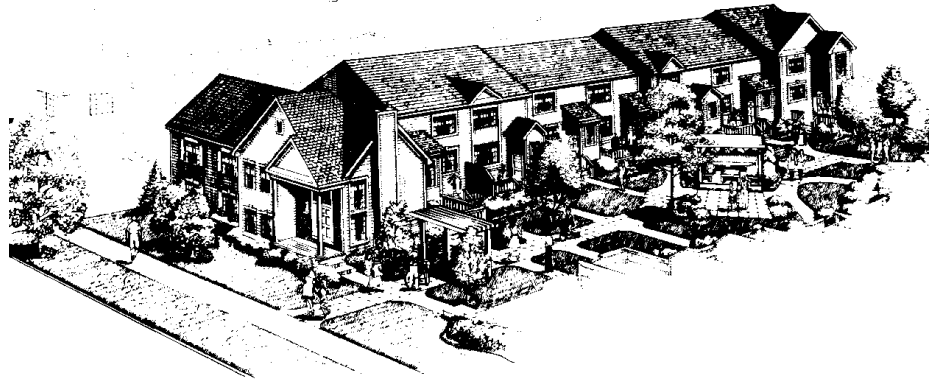

BRAUN COURT

Marin City, California

Braun Court contains 30 duplex units on an extremely steep hilly site. Innovative technology was used in the development of the site, which kept site development costs down and allowed these houses to be affordable. The site innovation included the use of a retaining wall system that economically integrated the shoring and foundation construction. The 8- to 10-foot retaining walls were constructed using a combination of excavation and earth-forming, which allowed them to be built from the top down. A concrete grade beam was poured at the wall's highest elevation, and then the earth beneath the beam was excavated to create a form. Steel reinforcing was placed against the earth form and gunnite was sprayed onto the rebar. After curing, the next 6 feet were excavated and the process was repeated. The units are designed in the Bay Area architectural style of wood-frame buildings. They have boosted insulation levels, prefabricated roof trusses, pre-engineered floor joists, and other prefabricated components. A local foundation provided mortgage downpayment assistance, while six other public and private agencies contributed funds for silent second mortgages to reduce the sales prices of the houses.



PROJECT PROFILE

Housing Type

Townhouse units with land held in common.

Technology and Design

Units incorporate prefabricated materials with energy-conserving insulation; major innovation in creation of buildable sites with retaining walls.

Project Size

30 units, averaging 1,200 square feet.

Housing Price

Units average \$145,000; 58 percent of reported median

Financing

Several first-time homebuyers programs, plus subsidy support from seven agencies.

PROJECT CREDITS

Kodama Associates (*architect*);
Ecumenical Association for Housing, Marin City Community Development Corp., Marin City Affordable Homes, Inc.

(*developers*);

Burman Feldman Builders (*contractor*);

G-N-G Engineers (*building structural engineer*);

SOH & Associates (*retaining wall structural engineer*);

Merrill + Befu Associates (*landscape architect*);

CSW/Stuber-Stroeh Engineering Group, Inc. (*civil engineer*);

Miller Pacific Engineering Group (*soils engineer*);

Bank of America (*construction loan*).



Additional Technology and Project Information

Kodama Associates
1701 Montgomery Street
San Francisco, CA 94111
415-296-1144 (phone); 415-296-1133 (fax)



Site work allowing the construction of level areas for development made home building possible in this hilly region. Wood-frame homes now cascade down the site, naturally following contours.



JINGLETOWN NEIGHBORHOOD FAMILY

Oakland, California

Jingletown was designed for the specific needs of first-time homebuyers in a Latino community and reclaims a neighborhood site for revitalization. The compact site plan mixes and shares functions to create a vibrant community. Architect Michael Pyatok, working with the nonprofit Oakland Community Housing, conducted a series of workshops (organized by Oakland community organizations) with people from the community to design 53 units on an urban site. The workshops resulted in a high-density site plan (25 units/acre) with houses that respond to the expressed needs of expandable homes that can grow as the families prosper. The houses are fee-simple, on land held in common. Daycare is provided in a community building on site. Some units contain in-law bedroom suites as accessible living quarters for grandparents or working children, and spaces for home businesses. The future expansion of the units was designed by the architect to be undertaken by the homeowner, so that the design quality of the community is preserved. Attic spaces have plumbing and electrical lines stubbed in and rough flooring to make expansion easier.

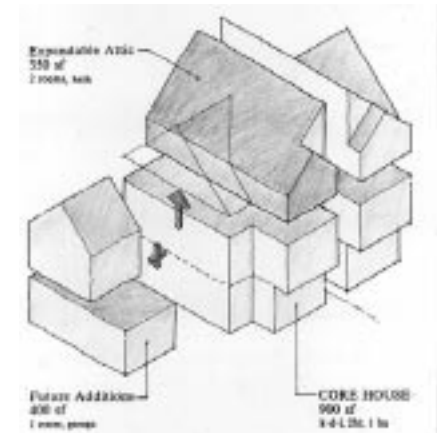

PROJECT PROFILE

Housing Type

Single-family townhouse units on compact urban site.

Technology and Design

Emphasis on compact site planning in mixed, shared site uses. Design of units that can easily be expanded for growing families, as well as accommodation of extended families and in-home businesses. Some accessible units.

Project Size

53 units, ranging from 900 to 1,200 square feet.

Housing Price

Units range from \$97,000 to \$129,000; 54% to 73% of reported median.

Financing

Non-profit developer, with some assistance from HOME funds and other public agencies.

PROJECT CREDITS

Pyatok Associates, Michael Pyatok (*architect*);

Irving Gonzales (*architect for construction administration*);

Oakland Community Housing, Inc., Warren Seeto, director (*non-profit developer*).

Additional Technology and Project Information

Pyatok Associates

339 15th Street, Suite 212

Oakland, CA 94612

510-465-7010 (phone); 510-465-8575 (fax)

The Jingtown site is developed to preserve the community identity, and to allow a variety of activities to take place on the site. Houses are easily expandable as families grow, and also allow living quarters for extended families.

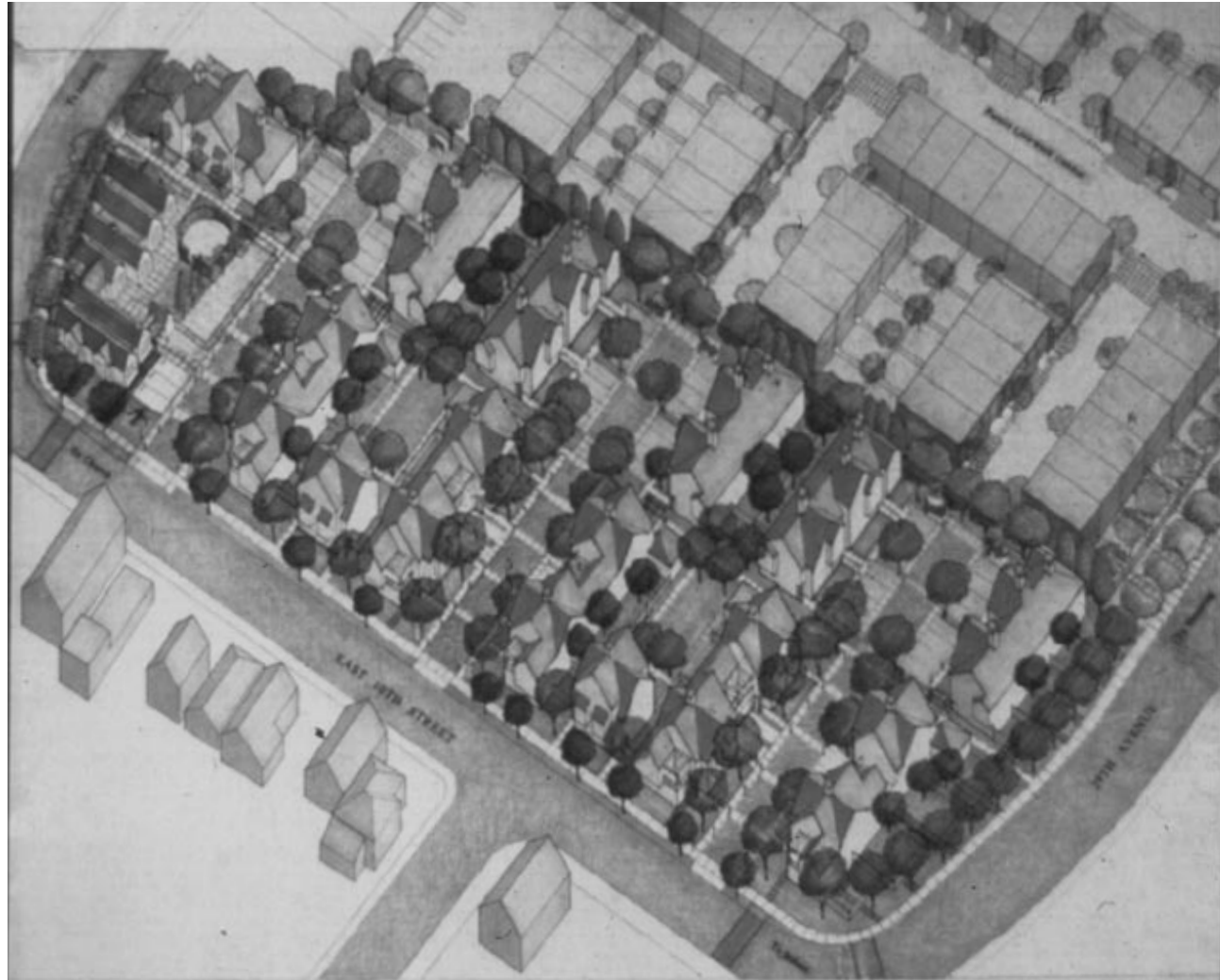
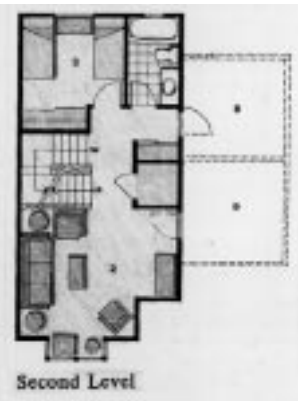
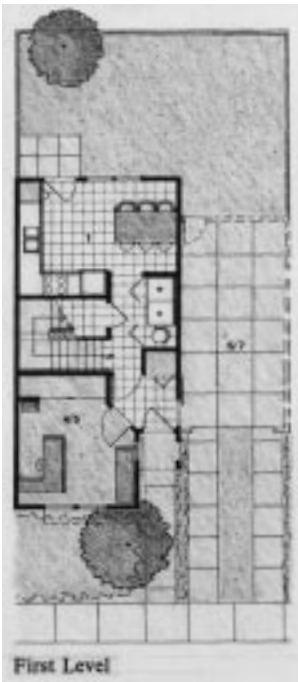



Exterior designs and finish materials are inspired by the traditional architecture of the neighborhood, using common elements such as bay windows, wood brackets, and roof shapes that are familiar to the residents. Site plan achieves a density that is appropriate for this urban site.



CITRUS VIEW HOMES

Piru, California

Citrus View Homes is a development in a low-income, predominantly Hispanic, agricultural community in rural Ventura County. The site was located in a flood-zone and therefore affordable for the planned subdivision. Various government agencies and subcontractors cooperated to designate the site a dump for county flood channel project soil. The developer compacted and graded the fill for an estimated \$500,000 savings. Additional savings are generated from using only three standardized house plans and structuring financing to allow for concurrent construction of a maximum number of units. A construction management firm provides job supervision and paperwork management for a fixed-fee. Cost-saving construction techniques include use of recycled plastic pipes for irrigation lines and sewer lines, aluminum energy efficient windows, trusses, pre-cut lumber (re-packaged off-site for each house), and perimeter floor gluing. The Ventura County Chief Administrative Office streamlined approval time for Citrus View to 8 months from the normal 3 years and contributed low- and no-interest loans for predevelopment expenses. Downpayment assistance of up to \$20,000 is available.



PROJECT PROFILE

Housing Type

Detached single-family homes in a rural development.

Technology and Design

Site upgraded with fill from county projects in good public/private partnership. Design emphasized ease of construction, with three standardized plans; prefabricated components, energy efficient elements.

Project Size

113 units, averaging 1,630 square feet.

Housing Price

Units offered at \$162,000; 71 percent of reported median.

Financing

Downpayment assistance; HOME funds; mortgage credit certificates.

PROJECT CREDITS

Affordable Communities, Inc.,
(builder/developer), Lynn J. Jacobs,
president

Chief Administrative Office,
Ventura County (map and perm it
processing);

Fillmore Unified School District
(school impact fees);

Piru Neighborhood Council;
Building Equity in Neighborhoods
(BEGIN)/HOME program (buyer
financial assistance).



Additional Technology and Project Information

Affordable Communities, Inc.
260 Maple Court, Suite 102
Ventura, CA 93003
805-644-4453 (phone); 805-644-6501 (fax)

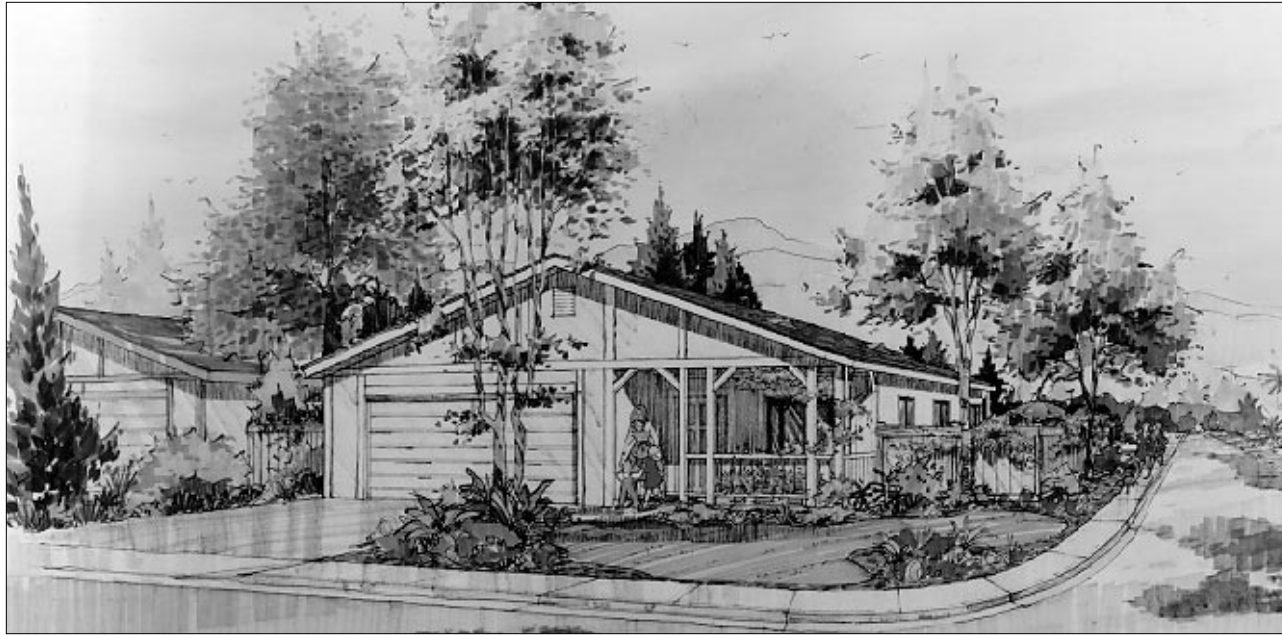

Citrus View homes are built on flood-zone sites built up with donated land-fill. Plans are standardized to incorporate sustainable and energy-saving features.

GARDEN COTTAGES

San Francisco Bay Area, California

The Garden Cottages projects are an on-going effort by San Francisco architect Donald MacDonald to provide low-cost homeownership in one of the most expensive real estate markets in the United States. Intended for urban sites (up to 60 units per acre and one parking space per unit), the cottages feature small decks and the opportunity for a small enclosed garden. The cottages are versatile for a variety of sites, can be built as individual buildings, or built adjacent to each other in series. The Garden Cottages are simple box structures, 20x20 feet, 12x30 feet, and 12x20 feet over a concrete slab, with standard doors, windows, and plywood siding. Inside, the innovative design places bedrooms on the first floor and living/dining/kitchen spaces on the second level. This not only makes the houses accessible, but allows future expansion to take place on the lower level without having to enlarge the living area at the second level. Although the units use standard, off-the-shelf materials, fixtures, and other equipment, the design can be modified to reflect the preferences of the owners.

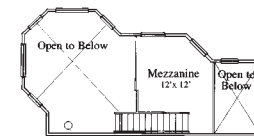

LOFT

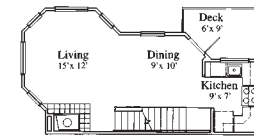

THIRD FLOOR

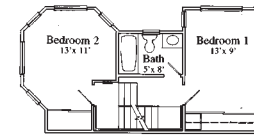

SECOND FLOOR

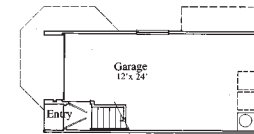

FIRST FLOOR

PROJECT PROFILE

Housing Type

Single-family units on scattered urban infill sites.

Technology and Design

Designed specifically for tight urban infill sites, with living spaces on second floor and bedrooms spaces on first to allow easy future expansion and increased accessibility. Constructed with standard, off-the-shelf materials and can be modified to reflect owners' preferences.

Project Size

Over 300 units built to date, averaging 900 square feet.

Housing Price

Units average \$160,000; 66 percent of reported median.

Financing

Private, with no federal or state subsidy.

PROJECT CREDITS

MacDonald Architects, Donald MacDonald (*architect*);
Muir Terrace Homes, San Rafael, CA;
Sosnowski and Associates (*developers*), J. Paul Sosnowski, Bill Cheek, Mike Mazzoletti (*builders*).
City Mews, San Francisco, CA;
KMR Properties (*developer*);
Buena Vista Builders, Gerry Agosta (*builder*).

Garden Cottages are compact to work efficiently on urban infill sites. Standardized designs can be combined in a variety of ways to allow a mixture of private gardens and on-site parking.



Additional Technology and Project Information

MacDonald Architects
 91 South Van Ness Avenue
 San Francisco, CA 94103
 415-626-9100 (phone); 415-626-9296 (fax)

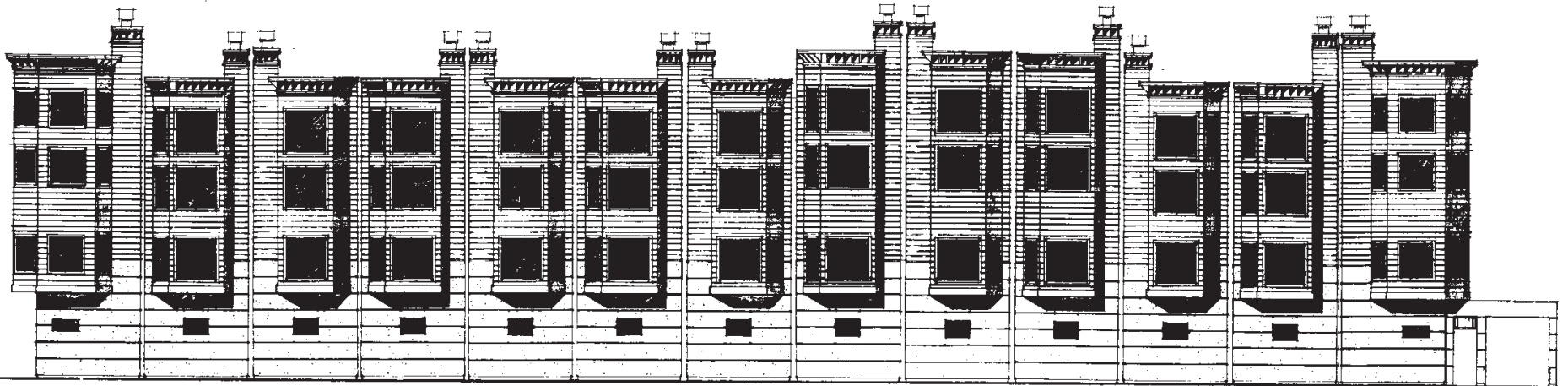

CLARA STREET ELEVATION

ACKNOWLEDGMENTS

A number of people and organizations should be recognized for their involvement with the Building Innovation for Homeownership awards program and this publication.

The projects were juried by a National Partners in Homeownership Board consisting of Diane Dorius of the Federal Home Loan Bank System, Barbara Materre of Fannie Mae, Emory Rogers of the Council of American Building Officials, Andrew Sholtz of the Manufactured Housing Institute, Debra Webster of the Enterprise Foundation, Robert Wible of the National Council of States on Building Codes and Standards, and representatives of HUD.

Projects were solicited from architects, builders, and developers from around the country by Aspen Systems, the National Association of Home Builders Research Center, and Steven Winter Associates, Inc.

HUD personnel involved in the awards program included David Engel, William Freeborne, Nelson Carbonell, Alan Rothman, Jacqueline Kruszek, and Gugu Moche.

This book is a collaboration of effort by the NAHB Research Center (particularly Carol Schaake, Mark Nowak, and William Farkas) and Steven Winter Associates (particularly Steven Winter, Peter Stratton, and Michael J. Crosbie, who served as editor). Andrew Kner and Michele Trombley were responsible for the design and layout, Diego Vainesman designed the symbols. Nelson Carbonell and David Engel of HUD's Office of Policy Development and Research coordinated the publication.