

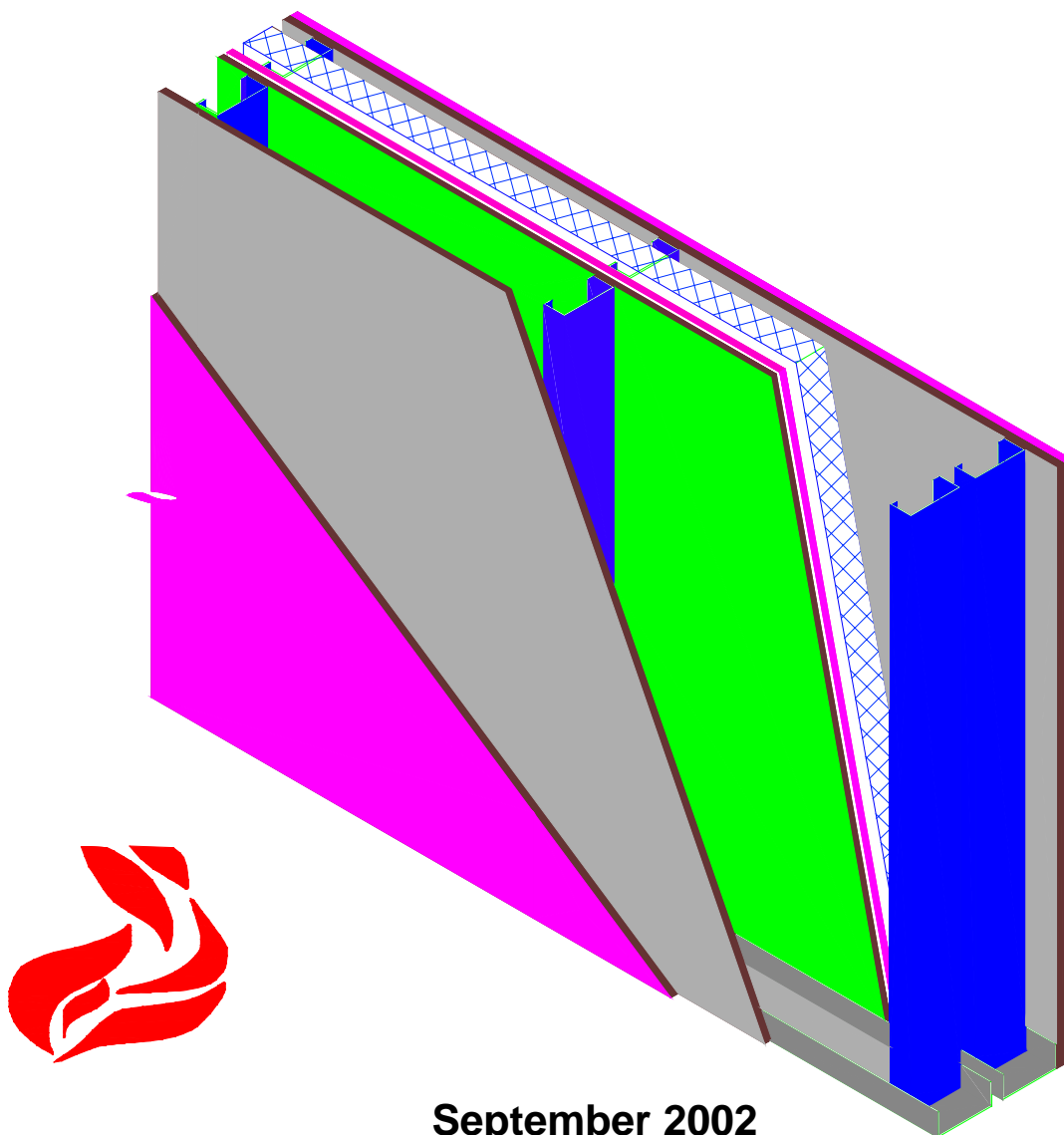

**U.S. Department of Housing and Urban Development**  
**Office of Policy Development and Research**

# **Residential Steel Framing**

## **Fire and Acoustic Details**



**September 2002**

## Residential Steel Framing – Fire and Acoustic Details

---

PATH (Partnership for Advancing Technology in Housing) is a new private/public effort to develop, demonstrate, and gain widespread market acceptance for the “Next Generation” of American housing. Through the use of new or innovative technologies, the goal of PATH is to improve the quality, durability, environmental efficiency, and affordability of tomorrow’s homes.

PATH is managed and supported by the Department of Housing and Urban Development (HUD). In addition, all Federal Agencies that engage in housing research and technology development are PATH Partners, including the Departments of Energy and Commerce, as well as the Environmental Protection Agency (EPA) and the Federal Emergency Management Agency (FEMA). State and local governments and other participants from the public sector are also partners in PATH. Product manufacturers, home builders, insurance companies, and lenders represent private industry in the PATH Partnership.

To learn more about PATH, please contact:



451 7th Street, SW  
Washington, DC 20410  
202-708-5873 (fax)  
e-mail: [pathnet@pathnet.org](mailto:pathnet@pathnet.org)  
website: [www.pathnet.org](http://www.pathnet.org)

Visit PD&R's Web Site

**[www.huduser.org](http://www.huduser.org)**

to find this report and others sponsored by  
HUD's Office of Policy Development and Research (PD&R).

Other services of HUD USER, PD&R's Research Information Service, include listservs; special interest, bimonthly publications (best practices, significant studies from other sources); access to public use databases; and hotline 1-800-245-2691 for help accessing the information you need.

# Residential Steel Framing

## Fire and Acoustic Details

Prepared for

The U.S. Department of Housing and Urban  
Development  
Office of Policy Development and Research  
Washington, DC

and

Steel Framing Alliance (SFA)  
Washington, DC

by

NAHB Research Center, Inc.  
400 Prince George's Boulevard  
Upper Marlboro, MD 20774-8731

Contract No. H-21310CA

September 2002

## Disclaimer

While the information in this document is believed to be accurate, neither the authors, nor reviewers, nor the U.S. Department of Housing and Urban Development, nor the Steel Framing Alliance, nor the NAHB Research Center, Inc., nor any of their employees or representatives make any warranty, guarantee, or representation, expressed or implied, with respect to the accuracy, effectiveness, or usefulness of any information, method, or material in this document, nor assumes any liability for the use of any information, methods, or materials disclosed herein, or for damages arising from such use.

Notice: The contents of this report are the views of the contractor and do not necessarily reflect the views or policies of the U.S. Department of Housing and Urban Development or the U.S. Government. The U.S. Government does not endorse producers or manufacturers. Trade and manufacturers' names appear herein solely because they are considered essential to the contents of this report.

## Acknowledgements

This report was prepared by Nader Elhajj, P.E., for the U.S. Department of Housing and Urban Development (HUD) and the Steel Framing Alliance (SFA). Special appreciation is extended to Bill Freeborne of HUD and Kevin Bielat of the Steel Framing Alliance for their guidance and assistance throughout the project. David Dacquisto provided technical review. Linda Marchman provided administrative assistance.

Appreciation is especially extended to members of the steering committee, listed below, whose input contributed to this work.

Kevin Bielat	American Iron and Steel Institute
Nader Elhajj	NAHB Research Center
Bill Freeborne	U.S. Department of HUD
Steve Fox	Canadian Sheet Steel Building Institute
Philip Grankowski	National Evaluation Service, Inc. (NES)
Jonathan Humble	American Iron and Steel Institute
Greg Ralph	Dietrich Industries, Inc.
Jay Larson	Bethlehem Steel Corp.
Bud Waters	Hunt Building Corporation
Dean Peyton	Anderson-Peyton Consulting Engineers
Jeffrey Proster	Brookfield Homes
Thomas Sheppard	Unites States Gypsum
Tim Waite	Steel Framing Alliance
Edward Wirtschoreck	National Evaluation Service, Inc. (NES)



## Forward

The NAHB Research Center, U.S. Department of Housing and Urban Development (HUD) and the Steel Framing Alliance have worked cooperatively to introduce cold-formed steel framing into the residential construction market and to provide objective builders and homeowners with a cost-effective alternative construction material. To accomplish this objective, many barriers have been overcome. However, one of the remaining barriers is the lack of adequate fire and acoustic details.

In response, HUD and the Steel Framing Alliance commissioned the NAHB Research Center to review current knowledge and develop a comprehensive list of fire and acoustic ratings for tested cold-formed steel assemblies. This “listing” is a state-of-the-art resource for the residential and light commercial building designers. A list of needed details and construction assemblies is also identified and recommended for testing.

Harold L. Bunce  
Deputy Assistant Secretary for  
Economic Affairs





## Executive Summary

Cold-formed steel has been widely used in commercial buildings, especially in non-load bearing (partitions) and curtain wall applications. Cold-formed steel sections are increasingly being used as primary structural members, such as beams, floor joists, and load-bearing walls in commercial and residential construction.

Despite the availability of cold-formed steel framing, there are still basic barriers that impede its adoption in the residential market. Probably one of the primary barriers is that the building industry is generally reluctant to adopt alternative building methods and materials unless they exhibit clear quality or performance advantages. The fire and acoustical performance of cold-formed floor and wall assemblies are important considerations when designing residential and light commercial structures. However, there is little information available in the United States (US) on fire ratings and sound transmission class ratings of cold-formed steel assemblies and the available information is dispersed and not readily accessible to end users.

This report investigates regulatory requirements, available test data, and typical practices relating to acoustics and fire protection of cold-formed steel framing. The intention is to give an overview of current regulations, as well as a “snap shot” of available fire and acoustic cold-formed steel assemblies.

This document starts by providing an overview of fire and acoustic requirements of cold-formed steel assemblies and the characteristics of such assemblies as related to fire and acoustic performance. A detailed description of current building codes and building code requirements for the fire protection and acoustical insulation of cold-formed steel assemblies follows. A comprehensive list of tested fire- and sound-rated assemblies is provided. Finally, recommendations are given to direct future tests and research.



# Contents

<b>LIST OF TABLES</b> .....	<b>XI</b>
<b>LIST OF FIGURES</b> .....	<b>XII</b>
<b>GLOSSARY</b> .....	<b>XIII</b>
<b>1 INTRODUCTION</b> .....	<b>1</b>
1.1 OBJECTIVE.....	1
1.2 RESIDENTIAL COLD-FORMED STEEL FRAMING .....	1
1.3 INTEGRATION OF FIRE AND ACOUSTIC PERFORMANCE.....	2
<b>2 FIRE CHARACTERISTICS OF COLD-FORMED STEEL FRAMING</b> .....	<b>3</b>
2.1 INTRODUCTION.....	3
2.2 COLD-FORMED STEEL AT ELEVATED TEMPERATURES .....	3
2.3 FIRE PROTECTION OF COLD-FORMED STEEL FRAMING BY GYPSUM BOARD .....	4
2.4 IMPORTANCE OF FIRE PROTECTION .....	5
<b>3 ACOUSTIC CHARACTERISTICS OF COLD-FORMED STEEL FRAMING</b> .....	<b>6</b>
3.1 INTRODUCTION.....	6
3.2 FUNDAMENTALS OF SOUND TRANSMISSION.....	6
3.3 METHODS OF MEASUREMENT .....	9
3.3.1 <i>Single Figure Ratings</i> .....	10
3.3.2 <i>Spectrum Adaptation Terms</i> .....	10
3.3.3 <i>Frequency Ranges</i> .....	10
3.4 ACOUSTIC CHARACTERISTICS OF COLD-FORMED STEEL FRAMING.....	10
3.4.1 <i>Separating Walls</i> .....	12
3.4.2 <i>Separating Floors</i> .....	13
3.4.3 <i>Impact Sound Transmission</i> .....	14
<b>4 BUILDING CODES, CLASSIFICATION AND OCCUPANCY</b> .....	<b>16</b>
4.1 INTRODUCTION.....	16
4.2 U.S. BUILDING CODES .....	16
4.2.1 <i>Model Code Organizations</i> .....	16
4.2.2 <i>Methods of Approval</i> .....	20
4.3 BUILDING CLASSIFICATION.....	21
4.3.1 <i>IBC Use and Occupancy Classification</i> .....	21
4.3.2 <i>Types of Construction</i> .....	22
<b>5 FIRE AND ACOUSTIC CODE REQUIREMENTS</b> .....	<b>23</b>
5.1 INTRODUCTION.....	23
5.2 FIRE REQUIREMENTS .....	23
5.2.1 <i>IBC Fire Requirements</i> .....	25
5.2.2 <i>BOCA Fire-Resistance Requirements</i> .....	28
5.2.3 <i>UBC Fire-Resistance Requirements</i> .....	29
5.2.3 <i>SBC Fire-Resistance Requirements</i> .....	30
5.2.4 <i>IRC, CABO and ICC IOTFDC Fire Requirements</i> .....	31

5.3	ACOUSTICAL REQUIREMENTS -----	33
5.4	DETERMINATION OF FIRE AND ACOUSTIC RATINGS -----	34
5.4.1	<i>Determination of Fire-Resistance Ratings</i> -----	34
5.4.2	<i>Determination of STC and IIC Ratings</i> -----	35
<b>6</b>	<b>FIRE AND ACOUSTIC DETAILS - INDUSTRY LITERATURE -----</b>	<b>37</b>
6.1	INTRODUCTION-----	37
6.2	FIRE-RATED ASSEMBLIES -----	37
6.3	ACOUSTIC ASSEMBLIES -----	41
<b>7</b>	<b>FIRE-RATED AND ACOUSTIC PERFORMANCE RATED DETAILS -----</b>	<b>43</b>
7.1	FIRE RATED ASSEMBLIES -----	43
7.1.1	<i>Walls</i> -----	43
7.1.2	<i>Floors</i> -----	54
7.2	STC AND IIC RATED ASSEMBLIES -----	56
7.2.1	<i>Walls</i> -----	57
7.2.2	<i>Floors</i> -----	59
<b>8</b>	<b>SUMMARY OF RESEARCH ON FIRE RATING AND ACOUSTIC PERFORMANCE OF COLD-FORMED STEEL FRAMING -----</b>	<b>61</b>
8.1	INTRODUCTION-----	61
8.2	FIRE RATING RESEARCH SUMMARY -----	61
8.2	ACOUSTICAL PERFORMANCE RESEARCH SUMMARY -----	64
<b>9</b>	<b>FIRE AND ACOUSTIC RESEARCH AND TESTING NEEDS FOR RESIDENTIAL APPLICATIONS -----</b>	<b>65</b>
9.1	INTRODUCTION-----	65
9.2	RESEARCH NEEDS -----	65
<b>10.</b>	<b>REFERENCES-----</b>	<b>69</b>

APPENDIX A - LIST OF U.S. FIRE- AND SOUND-RATED STEEL ASSEMBLIES

APPENDIX B - LIST OF CANADIAN FIRE- AND SOUND-RATED STEEL ASSEMBLIES

APPENDIX C – METRIC CONVERSION

## List of Tables

Table 3.1 - STC Of Various Construction Materials -----	7
Table 3.2 - Comparative Performance of Sound Insulation For An Ambient Noise Level of 30db-----	7
Table 4.1 - International Codes - Adoption By State-----	19
Table 4.2 – Assembly Group Occupancy (Based On 2000 IBC) -----	22
Table 4.3 - Types Of Construction (2000 IBC) -----	22
Table 5.1 - Required Separation Between Dwelling Units (Hours) -----	25
Table 5.2 – Fire-Resistance Rating Requirements For Building Elements (Hours)-----	26
Table 5.3 – Fire-Resistance Rating Requirements For Exterior Walls Based on Fire Separation Distance (Hours) -----	26
Table 5.4 – Fire Wall Fire-Resistance Ratings-----	27
Table 5.5 – Required Automatic Fire Sprinkler (AFS) Per 2000 IBC and 2000 IRC-----	27
Table 5.6 – Fire-Resistive Requirements For Structural Components Per The 1999 NBC -----	28
Table 5.7 – Fire-Resistive Requirements For Structural Components Per The 1997 UBC -----	29
Table 5.8 – Fire-Resistive Requirements For Structural Components Per The 1999 SBC -----	30
Table 5.9 – Fire-Resistant Separation Requirements in The IRC, CABO & OTFDC -----	31
Table 5.10 - STC And IIC Requirements Selected Codes -----	33
Table 5.11 - Test Methods For Fire-Rated Steel Assemblies -----	34
Table 5.12 - Test Methods For Acoustical Insulation -----	35
Table 6.1 - Summary of Industry Literature-----	38
Table 6.2 - Fire-Resistance Design Manual-Gypsum Systems -----	40
Table 6.3 – Fire Ratings of Tested Cold-Formed Steel Assemblies-----	41
Table 6.4 - Summary Of Industry Literature -----	42
Table 7.1 – Fire-Rated Wall Assemblies – Non Load Bearing -----	43
Table 7.2 – Fire-Rated Wall Assemblies – Load Bearing -----	50
Table 7.3 – Fire-Rated Floor Assemblies -----	54
Table 7.4 – Non-Load Bearing Walls – STC Rating -----	57
Table 7.5 – Load Bearing Walls – STC Rating -----	58
Table 7.6 – STC/IIC Rated Floor Assemblies-----	59

## List of Figures

Figure 1.1	Typical Cold-Formed Steel Sections.....	2
Figure 2.1	Strength of Steel at Elevated Temperatures Relative to Normal Yield Strength.....	4
Figure 3.1	Direct and Flanking Transmission.....	9
Figure 3.2	Schematic Showing the Principle of Double Layer Construction with Associated Acoustic Benefit.....	11
Figure 3.3	Sound Transmission Paths Through Cold-Formed Steel Walls.....	12
Figure 3.4	Typical Characteristics of a Double Steel Stud Separating Wall.....	13
Figure 3.5	Impact Sound with Different Surface Layers.....	14
Figure 4.1	Geographical Distribution of the I-Codes.....	18

## Glossary

*Absorbers.* Materials that have the capacity to absorb sound, such as acoustical tile and panels, carpeting, draperies and upholstered furniture.

*Acoustics.* The science of sound, including its production, transmission, and effect.

*Acoustic boards.* These boards are denser than regular wallboard but somewhat more flexible. As a general rule they Acoustic Boards give a sound reduction of about 2 dB greater than regular wallboard in typical partitions.

*Decibel.* A unit adopted for convenience in representing vastly different sound pressures. It is 20 times the logarithm to the base 10 of the ratio of the sound pressure to a reference pressure of  $0.0002 \text{ dyne/cm}^2$ . This reference pressure is considered the lowest value that the ear can detect.

*Draft Stop.* Building materials installed in concealed passages of building components such as attics, crawl spaces, and ceiling/floor assemblies to restrict the movement of air, smoke, and gases through large passages within those components to other areas of the building.

*Frequency.* The number of times that an action occurs in a given time period. In sound, the number of complete vibration cycles per second represented by the unit hertz (Hz).

*Fire Separation.* A construction assembly that acts as a barrier against the spread of fire.

*Fire-Resistance.* Fire-resistance designates the ability of a laboratory-constructed assembly to contain a fire in a carefully controlled test setting for a specified period of time.

*Fire-Resistance Rating.* The time in hours or fractions thereof that a material or assembly of materials will withstand the passage of flame and the transmission of heat when exposed to fire under specified test and performance criteria as prescribed by the applicable code.

*Firestopping (or Fireblocking).* Building materials installed to prevent or slow the movement of flames and gases to other areas of a building through small concealed passages in building components such as floors, walls, and stairs.

*Fire Protection System.* System, such as water fed sprinklers that provide early and automatic detection and suppression of developing fires.

*Firewall.* A type of fire separation of noncombustible construction which subdivides a building or separates adjoining buildings to resist the spread of fire and which has a fire-resistance rating as prescribed by the applicable building code and has sufficient structural stability under fire conditions to allow collapse of construction on either side without collapse of the wall.

*Hertz (Hz).* The unit of measure of frequency, representing cycles per second. Named for Heinrich R. Hertz, noted German physicist.

*Impact Insulation Class (IIC).* A numerical evaluation of a floor-ceiling assembly's effectiveness in retarding the transmission of impact sound. The U.S. Federal Housing Administration developed this single number rating.

*Impact Noise Rating (INR).* A single-number rating based on standardized test performance, for evaluating the effectiveness of assemblies in isolating impact sound transmission. INR rating method is being replaced by the Impact Insulation Class (IIC).

*Impact Sound Pressure Level (ISPL).* The sound pressure (in decibels) measured in a receiving room, resulting from the transmission of impact sound through a floor construction, produced by a standard "tapping" machine.

*Occupancy.* The use or intended use function of a building or part thereof for the shelter or support of persons, animals, or property.

*Occupancy Classification.* The level of hazard associated with identification of the occupancy of the building dictates a level of fire-resistance necessary to protect the occupants of the building.

*Octave.* The interval between a sound of one frequency and a sound with a frequency that is exactly double the first.

*Octave Band.* A frequency spectrum, which is one octave wide. Bands of one-third octave are used for recording sound test results and are designated by the center frequency of the band.

*Party Wall.* A fire wall on an interior lot line used or adapted for joint service between two buildings (such as between townhouses).

*Sound Pressure level (SPL).* Expressed in decibels, the SPL is 20 times the logarithm to the base 10 of the ratio of the pressure of sound to the reference pressure 0.0002 dynes per square centimeter.

*Sound.* The transfer of sound energy from one place to another, through air, structure, or other conductor.

*Sound Transmission Class (STC).* A rating system used to measure the insulation (or isolation) of airborne sound provided by a barrier. STC is determined from a sound-transmission-loss curve obtained from a standardized test of a large-scale specimen. The higher the STC rating, the more soundproof the construction.

*Sound Transmission Loss (STL).* The difference between the sound energy (sound pressure level) in a source room and a receiving room when the two rooms are separated by the system being tested. In general, the transmission loss increases with frequency, i.e. the higher the frequency the greater the sound transmission loss.

*Wallboard.* The most common gypsum board used. Typically the gypsum core density is 44.9 lb/ft<sup>3</sup> (720 kg/m<sup>3</sup>) giving a wallboard mass of about 1.85 lb/ft<sup>2</sup> (9 kg/m<sup>2</sup>) for 1/2" (12.5 mm) board thickness. Standard thicknesses are 9.5 mm (3/8"), 7/16" (12 mm), 1/2" (12.5 mm), 9/16" (15 mm), 5/8" (15.9 mm), and 3/4" (19 mm). Standard width is 48 inches (1200 mm).



# 1 Introduction

There are increasing demands for improvements in standards of construction quality, comfort and performance in housing. The residential construction market in the United States (U.S.) is constantly looking for new and improved methods for construction of residential buildings.

The market for cold-formed steel (CFS) framing in residential construction is potentially large as the construction benefits of durability, high strength, reliability, versatility recyclability, long life, and adaptability are realized.

An important consideration in many residential construction applications is fire and acoustical performance. However, this information is not easily found and may not be available for construction assemblies most relevant to residential construction. Therefore, this report provides an overview of the current U.S. building codes requirements related to fire and acoustic performance, and a compilation of fire- and acoustic-rated CFS assemblies. From this initial effort, additional fire and acoustic assemblies were identified for future tests and ratings.

This report focuses on residential construction, however, certain sections address light commercial applications, as the two markets possess similar characteristics when fire and sound ratings are involved.

## 1.1 Objective

The objectives of this report is:

- To increase the understanding of the acoustic and fire performance of CFS framing construction.
- To provide information on required levels and fire protection performance for dwellings using cold-formed steel framing.
- To provide information on fire and acoustic issues to consider when designing buildings with cold-formed steel framing.
- To identify gaps in available information to direct future research and dissemination activity.

## 1.2 Residential Cold-Formed Steel Framing

Light steel framing is now used successfully for housing in many countries (such as Canada, Australia, Japan, Korea, and the U.S.). In the United States approximately 1% of new housing starts are CFS [1]. CFS is also being used for applications such as fire separation walls within hot rolled steel-framed apartment and commercial buildings.

CFS framing is a term commonly used to refer to light-gauge steel members with thicknesses ranging from 0.033 to 0.118 inches (0.84 to 3.00 mm) that are produced by roll forming. These members may be wall studs, track, floor joists, roof rafters, bridging channels, furring channels, or related accessories (see Figure 1.1). Also included are non-load bearing drywall studs, which

have a steel thickness ranging from 0.018 to 0.033 inches (0.46 to 0.84 mm). CFS construction can use individual steel components or prefabricated panels, assembled on site using self-tapping screws to create a whole building structure.

The Steel Framing Alliance in cooperation with HUD and the NAHB Research Center, have standardized the residential steel framing members and produced a prescriptive approach to residential cold-formed steel framing [2]. This prescriptive approach was later adopted by U.S. building codes including the 1995 CABO One- and Two-Family Dwelling Code [3], the 1998 International One and Two Family Dwelling Code [17] and the International Residential Code (2000 IRC) [4].

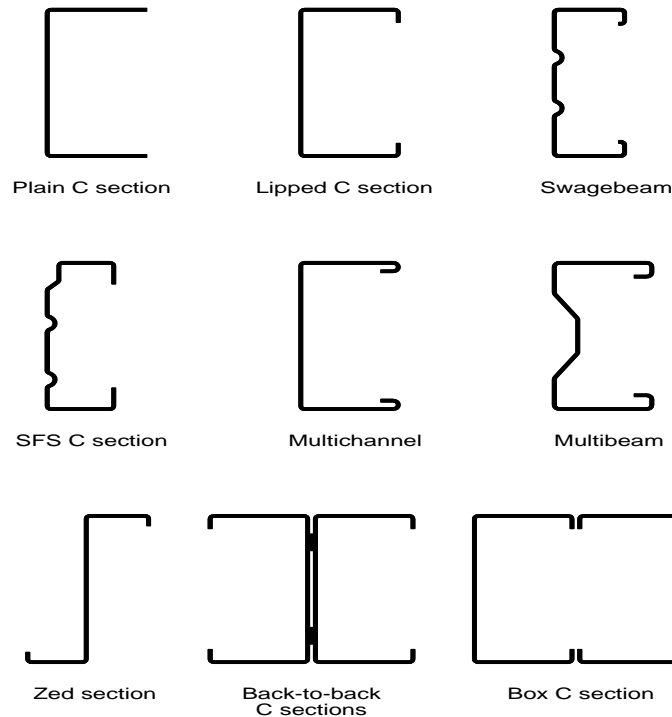

Figure 1.1 – Typical Cold-Formed Steel Sections

### 1.3 Integration of Fire and Acoustic Performance

Any evaluation of a construction method must look not only at the structural requirements but also at the total performance of the building. Two current technical issues regarding residential (and commercial) buildings are fire-resistance and acoustic performance. The methods used to achieve good acoustic performance and protection from fire are often similar and have an impact on each other. Requirements for fire separation and acoustic insulation in many building codes affect the same elements of the construction.

Principally, “acoustic separation is required in common interior walls, partition and floor ceiling assemblies between adjacent dwelling units and between adjacent dwelling units and adjacent public areas such as halls, corridors, stairs or service areas (Section 1206.1 of 2000 IBC [21]). Methods for achieving fire protection and good acoustic performance of CFS framing are

inevitably closely linked, and the provision of acoustic and fire separation is often achieved using the same constructions and materials.

## **2 Fire Characteristics of Cold-Formed Steel Framing**

### **2.1 Introduction**

Cold-formed steel (CFS) is widely used in commercial buildings, especially in non-load bearing (partitions) and curtain wall applications. CFS sections are also used as primary structural members such as load-bearing walls in commercial and residential construction. Although in single family dwellings CFS sections are not required to be fire resistant, in multi-family and commercial construction these members are often required to be fire resistant when they are part of a fire separation wall or where they support other floors required to be fire-resistant, floor/ceiling or roof ceiling assembly which includes structural elements such as columns, beams and girders.

Building codes frequently require a fire-resistance rating for steel-framed assemblies. The rating is based on fire tests conducted in accordance with recognized standard test methods. Fire rating of an assembly is a measurement that indicates how long the assembly will resist the spread of fire while maintaining structural integrity. Fire-resistance ratings are expressed by the number of hours (or minutes) that a wall assembly can maintain its integrity while containing the fire, smoke, and temperature of a working fire.

Life safety, and specifically fire protection, has been and will always be a primary concern of the building codes. Current U.S. building codes have significant requirements regulating the use of fire-rated assemblies, the installation of fire stopping (or fire blocking), draft stopping, and fire suppression systems.

Fire protection and fire separation between dwelling units are becoming more significant issues for the CFS framing industry as the technology is being adopted for taller apartment buildings and multi-family dwellings. Similarly, apartment buildings present additional acoustic separation challenges, particularly in floor construction. Furthermore, CFS frame elements are increasingly being integrated into steel framed buildings and the acoustic and fire performance data is needed.

### **2.2 Cold-Formed Steel at Elevated Temperatures**

Cold-formed steel-framed structures are inherently non-combustible, and do not contribute to fire spread. However, the load bearing capacity of steel at elevated temperatures depends on the temperature level and temperature distribution within the steel components. CFS possesses little fire-resistance because the steel sections tend to heat up quickly if directly exposed to fire. Therefore, it is imperative to provide some additional fire protection in most applications to ensure stability of the structure or the integrity of structural walls in fire conditions.

The modulus of elasticity and strength of steel decrease as its temperature rises and the temperature gradient through the section causes additional bending moments in the stud. According to a British Steel report [5], steel is maintained at its full strength until it reaches a temperature of 750°F (400°C). Above that temperature the strength quickly decreases. The loss of strength (yield strength) of CFS at elevated temperatures exceeds that of hot rolled steel by between 10 and 20% based on data obtained from tests performed by British Steel [5] as represented in Figure 2.1. According to tests conducted in the United States [6] using the ASTM E119 [7] method, average steel temperatures at wall failure ranged from 740°F (390°C) to over 1000°F (530°C) with one wall attaining temperatures of 1,800°F (980°C). This wide range of failure temperatures illustrates that endurance under fire conditions is more dependent on the composition of the assembly than on the steel itself. Moreover, Klippstein [6] concluded that the size of steel sections has an effect on the load bearing capacity as the temperature increases. Thus, structural integrity during a fire is dependent on fire protection measures.

Fire protection measures can be achieved in a number of ways, but most commonly appropriate (board) coverings are used to surround the steel with fire resisting materials. Board materials such as gypsum boards, cementitious boards or gypsum fiberboards for walls and ceilings and timber based boards for floors can readily provide up to 120 minutes of fire protection. The use of mineral wool insulation materials also adds to the fire protection.

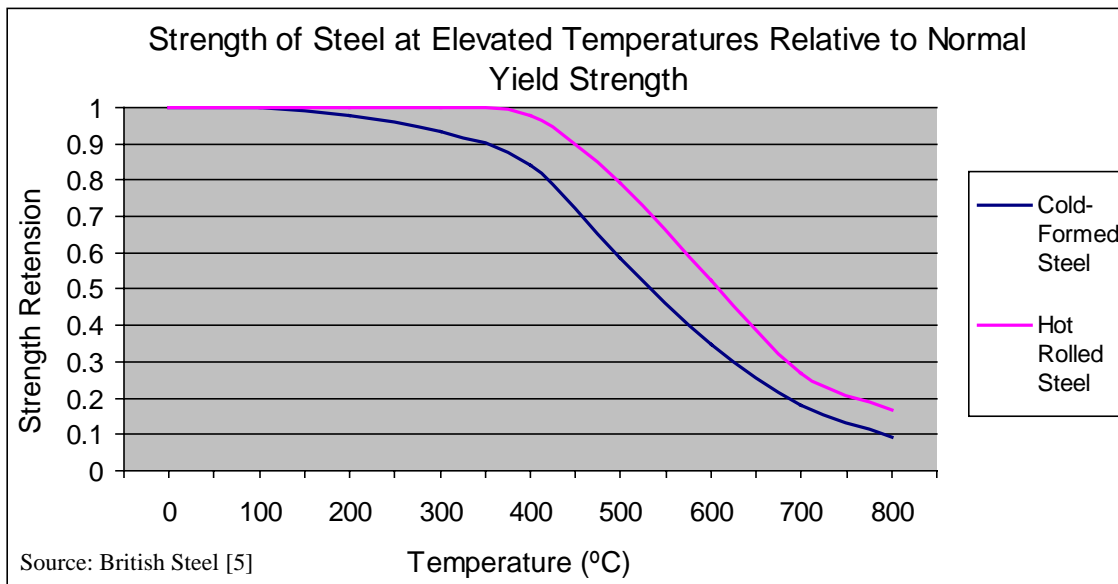

**Figure 2.1 - Strength of Steel at Elevated Temperatures Relative to Normal Yield Strength**

### 2.3 Fire Protection of Cold-Formed Steel Framing By Gypsum Board

CFS framing generally achieves fire separation by the use of layers of gypsum board. When exposed to fire the free water and chemically combined water in the gypsum is gradually driven off at temperatures above approximately 212°F (100°C). This causes a temperature plateau on the

unexposed face of the lining. This process of removal of chemically combined water is called calcination and results in a loss of strength and shrinkage of the sheet material. The resultant product is a powder, which has much less strength than the original gypsum. Further gradual product disassociation occurs at temperatures exceeding 392°F (200°C).

Gypsum panel and plasterboard manufacturers typically provide fire data based on laboratory fire tests. In the U.S., these tests are carried out to ASTM E119 [7]. In general, a fire-resistance rating of 30 minutes is readily achievable using one layer of 1/2-inch (12.8 mm) gypsum wallboard and 60 minutes is achieved using multiple layers of gypsum wallboard. Greater periods of fire protection are also possible using additional layers. Cementitious board or gypsum fiberboard of varying thickness can also be used to replace one or more of the gypsum boards. Furthermore, when multiple layers of boards are used, their joints should be staggered to maximize integrity in fire.

## 2.4 Importance of Fire Protection

Building codes typically set the acceptable height and area limits of buildings based on the combustion characteristics of the structure. Because low-rise residential buildings are typically smaller than other types of buildings, they only have to meet minimum fire requirements. Such construction is often termed “Combustible – Unprotected” in building codes (for single family dwellings and townhouses).

Fire ratings and fire separation requirements vary based on the type of construction. All U.S. building codes require that exterior wall construction within some distance from the property line be of one-hour construction. One-hour fire resistive walls that are continuous to the underside of the roof sheathing, on the other hand, must separate dwelling units in a two-family dwelling. A two-hour separation is usually required between townhouse units. Two-hour fire-rated wall and floor assemblies are required between units in multifamily buildings. The most common method of achieving the required fire separation is by using drywall or plasterboard. It is a challenge for designers and builders to use a common detail that satisfies both the fire separation and acoustic insulation requirements (i.e., STC). For example, while it is easy to achieve the fire separation requirements, it is usually difficult to achieve the acoustic rating (STC or IIC) in floors of apartment buildings. Therefore, fire-rated steel assemblies should satisfy both fire and acoustic requirements to the greatest extent possible.

It is necessary to consider the detail design of walls and floors and in particular the junctions between elements and the potential effect of penetrations through the lining boards to meet the requirements for fire and also to achieve the required acoustic performance.

## **3 Acoustic Characteristics of Cold-Formed Steel Framing**

### **3.1 Introduction**

Acoustic insulation criteria often influence the design of floors and walls in multi-occupancy dwellings such as townhouses, apartments, assisted living facilities, and hotels. Even in single-family dwellings it may be necessary (although rarely) to consider some method of sound reduction (attenuation) between some rooms. Although sound insulation construction will add to building costs, the expenses of correcting acoustical mistakes usually are several-fold higher. In addition, complaints from occupants can affect the acceptance and long-term viability of construction systems. Issues such as flanking transmission can be significant and could reduce the effectiveness of the overall acoustic rating of a specific structure. A proper detail is one that provides required fire separation, adequate acoustical insulation, and proper thermal insulation.

Sound and vibration sources are usually associated with speech and noise from normal occupant activities, such as traffic, music, and mechanical equipment. During sound transmission in buildings and other structures, some of the sound energy is absorbed or dissipated, some is reflected from various surfaces, and some is transmitted through the building materials and furnishings. Builders and designers are usually interested in reducing or eliminating the amount of sound transmitted through building materials by means of barriers and enclosures, acoustically absorbent materials, and other materials and systems properly shaped and assembled.

### **3.2 Fundamentals of Sound Transmission**

Sound levels and sound insulation values are expressed in decibels (dB). The dB rating is a representation of the magnitude of the sound (i.e., measure of the amount of sound transmitted from one medium to another or from one room to another).

The sound rating of building materials or construction assemblies is typically given in a Sound Transmission Class (STC). The STC is a rating system used to measure the insulation (or isolation) of airborne sound provided by a barrier. STC is determined from a sound-transmission-loss curve obtained from a standardized test of a large-scale specimen. The higher the STC rating, the more soundproof the construction. Table 3.1 provides typical STC ratings of common building construction materials.

Sound insulation is an interrelationship between loudness of the source side, the acoustic performance of the dividing barrier and the background noise level on the receiving side of the barrier. The background noise plays an important part. Apartments located in quiet suburbs need higher sound insulation between units than apartments located on busy roads.

Table 3.2 indicates the situation of different noise sources likely to occur in a typical apartment, and their relative audibility for a typical suburban background noise level of 40 dB. This relates to 30 dB background in the apartment with the windows open.

**Table 3.1 - STC of Various Construction Materials**

Building Component	STC
¼-inch plate glass	26
¾-inch plywood	28
½-inch gypsum board, both sides of 2x4 studs	33
¼-inch steel plate	36
Concrete block: Autoclaved aerated	45
3-inch concrete wall	47
6-inc Reinforced concrete slab (4-1/8" thick)	44
6-inch concrete block wall	42
8-inch reinforced concrete wall	51
12-inch concrete block wall	53
12-inch Brick	56
2x4 wood studs (16" o.c.) with 1/2" GWB both sides	33-39
1-5/8 inch steel studs (24" o.c.) with 1/2" GWB both sides	39
3-5/8 inch steel studs (24" o.c.) with 5/8" GWB both sides	40-44
3-5/8 inch steel studs (24" o.c.) with 1/2" GWB both sides	39

Source: Australian Building Code Board [8], HUD Report [9], LGSEA [10].  
For SI: 1 inch = 25.4 mm

**Table 3.2 - Comparative Performance of Sound Insulation for an Ambient Noise Level of 30dB**

Type of Noise	STC (dB) Value Using Steel-Framed Assemblies				
	40	45	50	55	60
Normal Speech	Audible	Just audible	Not audible	-	-
Raised Speech	Clearly audible	Audible	Just audible	Not audible	-
Dinner Party/Laughter	Clearly audible	Audible	Just audible	Not audible	Not audible
Shouting	Clearly audible	Clearly audible	Audible	Just audible	Not audible
Small Television/Small Entertainment System	Clearly audible	Clearly audible	Audible	Just audible	Not audible
Large Television/Large Entertainment System	Clearly audible	Clearly audible	Clearly audible	Audible	Just audible
DVD with Surround Sound	Clearly audible	Clearly audible	Clearly audible	Audible	Audible
Digital Television with Surround Sound	Clearly audible	Clearly audible	Clearly audible	Audible	Audible

Source: Australian Building Code Board [8].



There are three types of sound transmission:

***Airborne Sound Transmission*** between rooms can be measured by generating a steady sound of a particular frequency in one room (source room) and comparing it with sound pressure level in an adjacent room (receiving room). The level difference is simply the difference between the source and the receiving levels. However, the level difference is influenced by the acoustic absorption in the receiving room. This is measured by the reverberation time (the time taken for a reverberant noise to decay by 60 dB).

***Impact Sound Transmission*** tends to be most relevant for floors. It arises from a variety of sources, most notably the movement of people within a building, but also from such things as the slamming of doors. A standard impact sound source (tapping machine) is used to strike the floor and the impact sound pressure level is measured in the room below. Measurements in a building can be standardized to a reverberation time of 0.5 seconds, giving the Standardized Impact Sound Pressure level.

***Structure-Borne Sound Transmission*** occurs when building elements (walls, floors) are set into vibratory motion by direct mechanical contact with vibrating sources (such as mechanical equipment or domestic appliances).

Building regulations typically set out requirements for airborne sound insulation of walls between dwellings (separating walls), and both airborne sound insulation and impact sound transmission for floors between dwellings (separating floors). Structure-borne sound transmission is not typically addressed in building codes. Reduction in sound transmission from the airborne and impact sound transmission sources is generally achieved by adopting special multi-layered construction (such as resilient layers in floors) or introducing additional mass. Adding resilient layers (such as dense fiberboard) to floors will significantly improve impact sound transmission.

Transmission of airborne noise from one room to an adjoining room, separated by a continuous intervening partition, can occur by two routes:

1. directly through the separating structure (direct transmission), and
2. around the separating structure through adjacent building elements (i.e., through other walls, ceilings and floors, or through corridors adjacent to such rooms) (flanking transmission).

Flanking and direct transmissions are illustrated in Figure 3.1.

Sound insulation for the flanking and direct transmission are controlled by the following characteristics:

- Mass
- Sealing
- Isolation



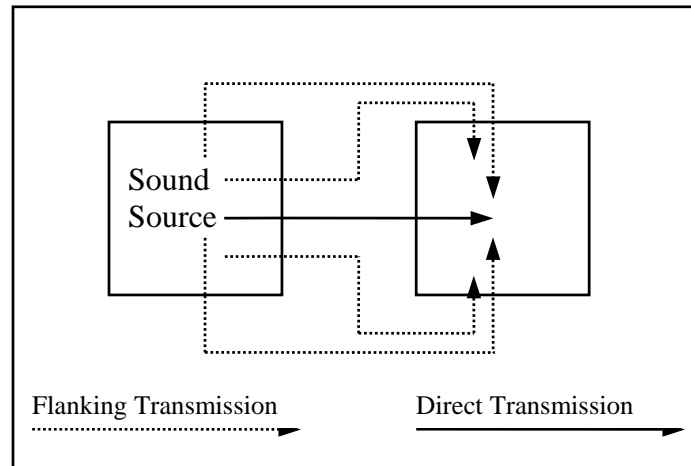

**Figure 3.1 – Direct and Flanking Transmission**

Direct transmission is easy to predict by conducting laboratory tests because it depends on the properties of the separating walls. On the other hand, flanking transmission, is far more complex and much more difficult to trace or predict because it is influenced by the building configuration and orientation. Flanking transmission is usually the more serious offender and commonly occurs with airborne as well as structure-borne noise.

Sound transmission across solid walls or single skin (one layer) partitions obeys the mass law principle. The mass law suggests that the sound insulation of a solid element increases by 5 dB per doubling of mass. The mass law principle, however, does not apply to light frame construction, which achieves a far better sound insulation than the law would suggest. This behavior is due to the presence of a cavity and the degree of isolation between the different layers of construction. The overall performance of a double skin (two layers) partition can therefore be determined by simply adding together the sound insulation ratings of its constituent elements, whereas the mass law would have suggested only a 5-dB improvement.

### 3.3 Methods of Measurement

Humans experience sound at a range of frequencies (high or low pitch), and most sounds are a mixture of several different frequencies. However, the sound insulation effectiveness of walls and floors vary with sound vibration frequency and so certain frequencies within any sound are likely to be attenuated more effectively than others by any given construction. Low frequency sounds are generally attenuated less than high frequency sounds, particularly in lightweight constructions. Therefore, sound insulation characteristics of walls and floors are normally measured at a number of different frequencies across the hearing range, usually 16 bands from 100 Hz to 3150 Hz (one third octave bands). However, there is increasing concern about the importance of low frequency sound as many typical noise disturbances such as heavy beat music and traffic noise are strong at the low frequencies. There are some problems with measurement at low frequencies, but methods that more accurately reflect the low frequency performance of walls and floors are being increasingly researched.

### 3.3.1 Single Figure Ratings

Single Figure Rating is widely used in the United States and Europe. This method assigns a single value (such as STC rating) for a certain assembly. The rating value is derived from comparing a number of measured test results to a set of reference results (a reference curve) over a known frequency range (refer to Table 3.1 for typical STC values of certain construction materials).

### 3.4.2 Spectrum Adaptation Terms

The shape of the reference curves used in the single figure ratings reflects the way sound is perceived by the human ear. However, the Europeans introduced Spectrum Adaptation Terms to take into account different spectra of noise (living activity and traffic noise) and to assess sound insulation curves with very low values in a single frequency band (the validity of the rating achieved with the reference curve alone is limited for such cases) [11].

### 3.3.3 Frequency Ranges

Sound insulation capabilities of walls and floors vary with the frequency of the noise. Sound transmission from any given construction will be attenuated at certain frequencies more effectively than others. Recognizing this fact, the Europeans adopted a frequency range that allows some flexibility in calculation of the spectrum adaptation terms [11].

## 3.4 Acoustic Characteristics of Cold-Formed Steel Framing

For sound to be transmitted it requires an elastic medium where particles vibrate. The most common medium is air, but sound is also transmitted through building materials. When airborne sound is generated, air particles vibrate, and when they encounter stiff building elements they induce oscillations in these materials that in turn induce oscillations in the air in neighboring rooms. Impact sound occurs when an impact to a building element induces oscillations within that element that are transferred into the neighboring air and through other building elements.

Traditionally, acoustic insulation has been associated with high ‘mass’, which reduces the vibrations that are induced by any given sound energy level. However, this practice is often inefficient and ill suited for prefabrication and stick-frame steel construction. Lightweight constructions are designed with a different approach including the use of:

- separate layers of mass,
- resilient layers to reduce the transmission of sound between mass layers,
- isolation between multiple layers of materials, and
- absorbent layers.

Such practices have been shown to provide high levels of sound insulation between dwellings or rooms.

## Layered Construction

Cold-formed steel (light-frame) constructions provide far better standards of sound insulation than the mass law would suggest. This is achieved by separating the layers that make up the element from each other as far as possible to act independently. Thus, in separating walls, two parallel stud walls are often constructed close to each other, which have minimal structural connection, each with a gypsum board internal finish. These act to a large extent as two independent walls and the acoustic separation can be nearly doubled. Increasing the mass of each layer by adding additional layers of gypsum (or plaster) boards will increase mass and so further improve acoustic insulation.

Figure 3.2 illustrates the importance of acoustic separation. The acoustic insulation of individual elements within a double-layer wall tends to combine together in a simple cumulative linear relationship, as long as the two layers are largely structurally separate. The overall performance of a double skin wall, for instance, can generally be determined by simply adding together the sound insulation ratings of its constituent parts. In this way, two comparatively lightweight walls of say 30-dB sound reduction can be combined to give acoustically enhanced wall with a 60-dB sound reduction. However, the mass law would only suggest a 6-dB improvement [12].

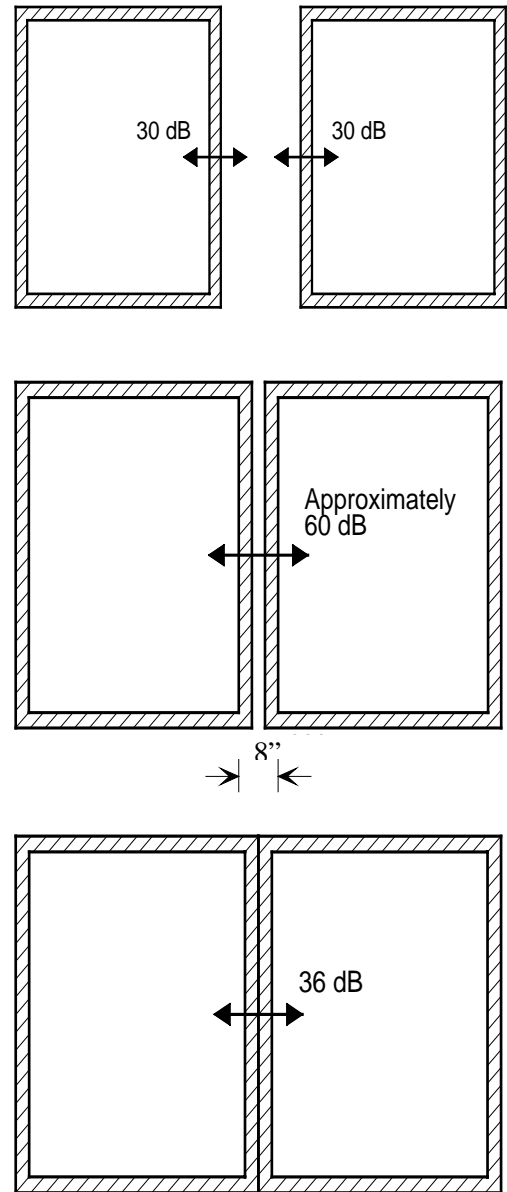

**Figure 3.2- Schematic Showing the Principle of Double Layer Construction with Associated Acoustic Benefits**

### 3.4.1 Separating Walls

A typical cold-formed steel single stud wall has three possible paths for sound transmission (Figure 3.3).

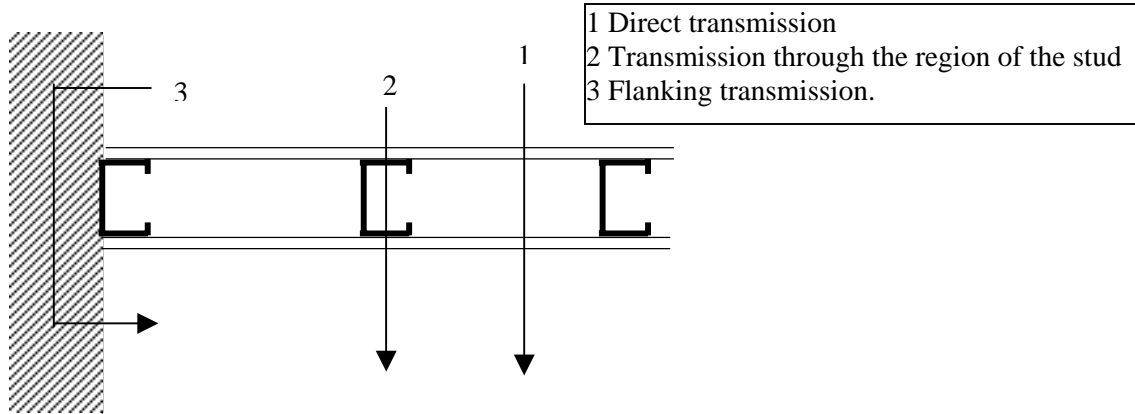

**Figure 3.3 - Sound Transmission Paths Through Cold-Formed Steel Walls**

The most significant problems are generally caused by transmission due to the effect of the studs. The studs transfer the vibrations in one wall lining directly to the other and thus to the room beyond. To improve acoustic performance the structural links between the two gypsum board layers should be reduced so the wall acts as two independent leaves. This can be achieved in a number of ways:

- Two separate parallel stud walls are often constructed with a small cavity (0.8 to 2 inches) (20–50 mm) between them. They have minimal structural connection, each with a gypsum board finish to the room side. The walls act to a large extent as two independent walls and the acoustic separation can be nearly doubled.
- The studs can be designed to reduce the transfer of sound, which can be achieved by introducing some resilience within the web or by the detail design of the shape of the stud.
- The connection between the gypsum board lining and the steel can use resilient connections, which allow some flexibility and reduce sound transmission. The connection can be achieved by the use of cold-formed resilient steel channels (also called bars) or acoustic profiles that have a corrugated web and are installed perpendicular to the studs and to which the gypsum board is attached.

Figure 3.4 shows a typical separating wall, constructed of cold-formed steel, used commonly in multi-family dwellings.

Increasing the mass of each wall lining by adding additional layers of gypsum board will further improve acoustic insulation. Other enhancements include acoustic absorbent materials, usually rock wool, or glass wool within the space between the two leaves or within one or both frames, and additional sheathing layers on the cavity side of each leaf.

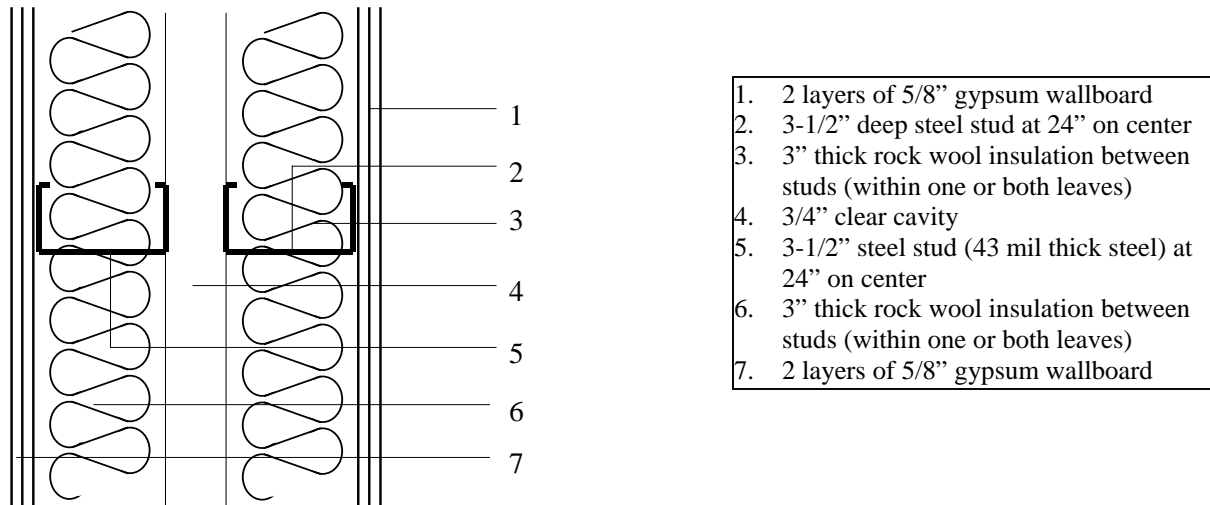

**Figure 3.4 - Typical Characteristics of a Double Steel Stud Separating Wall**

### 3.4.2 Separating Floors

One or more of the following achieves the required airborne sound insulation in CFS floors:

- structural separation between layers,
- appropriate mass in each layer,
- sound absorbent quilt, or
- minimising flanking transmission at floor-wall junctions.

The different layers of a typical CFS floor are as follows:

#### Ceiling

Usually one or more layers of gypsum board are fixed to the steel floor joists through resilient channels (resilient ceiling). The use of resilient channels improves both airborne and impact sound insulation compared to gypsum boards fixed directly to the joists. However, the resilient ceiling amplifies the sound pressure levels near the natural resonant frequencies of the floor, which occur in the range of 25 to 50 Hz. Thus, in general resilient ceilings decrease impact sound insulation at frequencies below 50 Hz, which are the frequencies generated by walking.

#### Floor Structure

Cold-formed steel floor joists can be covered with a wood-based board (plywood, OSB or chipboard), a cement particleboard or reinforced gypsum fiberboard. Alternatively, a profiled steel deck can be used with a gypsum board laid on top to provide a base for a resilient layer. To increase mass (and consequently improve performance) a concrete topping of 2 to 2.75 inches (50 to 70 mm) can be laid on the profiled steel deck. Acoustic absorbent, in the form of mineral wool, can also be inserted between the steel joists.

## Floating Floor

In separating floors, a layer of resilient material, usually in the form of dense mineral wool insulation (3.75 to 6.25 lb/ft<sup>3</sup>; 60 to 100 kg/m<sup>3</sup>) is usually placed on the structural floor deck and the finish floor layer of appropriate sheathing material is laid on top. Sometimes a layer of gypsum board is inserted under or on top of the resilient layer. The effect of the floating floor can be a 5 to 8 dB improvement in impact sound insulation and also a significant improvement in airborne sound insulation [13,14,15].

## Floor Covering

The improvement in impact sound insulation of soft floor coverings on light CFS floors with a floating floor is less than for heavyweight CFS floors. Research has shown that soft floor coverings have a greater impact in filtering out high frequency sound than low frequency sounds [13,16]. Thus, carpets improve impact resistance for frequencies above about 200 Hz, with improvements of up to 10 dB at certain frequencies (see Figure 3.5). Overall, the impact sound rating is improved by about 1.5 dB to 2.5 dB depending on the type of floor covering.

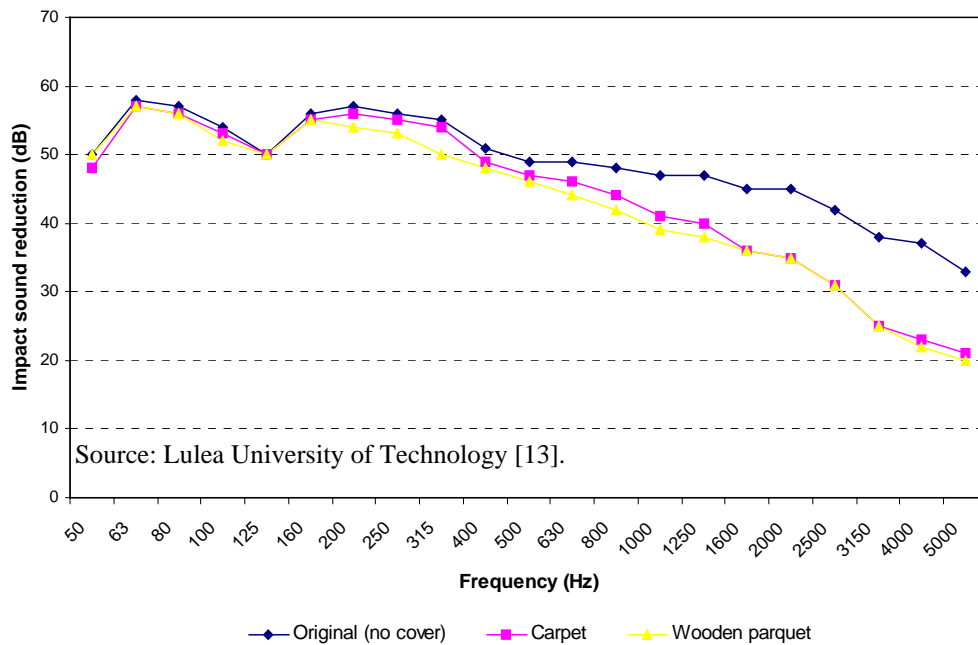

Figure 3.5 - Impact Sound with Different Surface Layers

### 3.4.3 Impact Sound Transmission

Lightweight steel floors can have reduced impact sound insulation performance at low frequencies compared to heavier floors. Conversely they show better performance at the higher frequencies. Reduction of impact sound transmission in lightweight steel floors can be achieved by:

- specifying an appropriate resilient layer with correct dynamic stiffness under imposed loadings;
- ensuring that the resilient layer has adequate durability; and
- isolating the floating floor surface from the surrounding structure at the floor edges. This can be achieved by returning the resilient layer up the edges of the walking surface.

### **Low Frequency Impact Sound**

Many site measurements have shown that buildings with lightweight floors can be built to meet the requirements for acoustic performance (airborne and impact) using the current acoustic rating methods. However, responses from occupants suggest that low frequency sounds, below 100 Hz, which are not included in the commonly used acoustic rating methods, are sometimes audible or felt as non-audible vibrations and have a significant impact on occupant perceptions. Research in Finland [14] shows that occupant perceptions do not coincide well with the IIC rating and floors with a good IIC rating may be judged to be unacceptable by occupants.

Walking on a lightweight steel floor generates low frequency "thumps" which are sounds mainly at frequencies of between 25 and 100 Hz, with peaks occurring at about 32 to 50 Hz. These frequencies are not represented in the currently used rating methods, and at these frequencies it is difficult to achieve accurate measurements on site.

Therefore, it is possible that the standard acoustic rating methods do not coincide well with occupant perceptions with regard to the effects of walking, and that low frequency sounds are not well represented. There is some debate over what is the proper way to rate low frequencies, and which of the rating methods is most appropriate. Research in Scandinavia [15,16] concludes that the opinions of inhabitants about the acoustic performance of lightweight steel floors are based largely on performance at low frequencies, below 100 Hz. This research suggested that rating methods that operate from 50 Hz might correspond somewhat better with the subjective ratings than the rating methods that start at 100 Hz.

## 4 Building Codes, Classification and Occupancy

### 4.1 Introduction

A Building Code is a collection of regulations (such as exit sign and smoke detector requirements), which pertain to specific subjects (such as fire protection systems), which regulate specific practices (such as designing, constructing or remodeling buildings). Current building codes provide a process for regulations to reflect current technology in construction methods and materials.

No matter what the specific subject may be - construction, property maintenance, fire preventions, or plumbing – All codes have the same purpose: To protect the public's health, safety and welfare from tragedies due to fire, structural collapse and general deterioration of the structures (such as homes, schools, stores and manufacturing facilities.). Building codes provide protection by reducing potential hazards to building occupants and adjoining properties.

### 4.2 U.S. Building Codes

Building construction in the United States is governed by interrelated codes and standards that regulate building, plumbing, gas, mechanical, electrical, energy, fire, and other specialized aspects of building construction. By definition, a building code is a legal document, which sets forth requirements to protect the public health, safety, and general welfare as related to the construction and occupancy of buildings and structures. In so doing, codes generally set forth requirements for structural design, materials, environmental control, fire protection, light and ventilation, and energy conservation.

While a small number of municipalities (mostly major cities) write and revise their own building code, most jurisdictions adopt one or more of the national model building codes. These codes, which are written, maintained, revised, and distributed by the model code organizations, are adopted by state or local jurisdictions either as written or more commonly with specific amendments. There are many thousands of individual code jurisdictions in the United States.

Current U.S. model building codes have significant requirements regulating the use of new building products and systems (such as cold-formed steel). Some of these requirements are fairly straightforward while others are subject to interpretation. This creates an element of uncertainty in terms of gaining approval. Different building codes may also have slightly different requirements for new building materials, products, and systems.

#### 4.2.1 Model Code Organizations

Currently, there are four U.S. national model-building codes that regulate all types of construction. In addition there are two model codes specifically for residential construction—the *1998 International One and Two-Family Dwelling Code* (formerly published by CABO) [3,17]



and, most recently the *2000 International Residential Code* (IRC) [4]. Furthermore, some localities in the United States, in particular large cities such as New York or Los Angeles, have their own codes that are often stricter than the model building code requirements. The four major model building code organizations are as follows:

- 1) The **International Conference of Building Officials** (ICBO) [18], headquartered in Whittier, California, publisher of the *Uniform Building Code* (UBC) and other Uniform Codes (but not the Uniform Plumbing Code).
- 2) The **Building Officials and Code Administrators International, Inc.** (BOCA) [19], headquartered in Country Club Hills, Illinois, publisher of the *BOCA National Building Code* (NBBC) and other National Codes.
- 3) The **Southern Building Code Congress International, Inc.** (SBCCI) [20], headquartered in Birmingham, Alabama, publisher of the *Standard Building Code* and other Standard Codes.
- 4) The **International Code Council, Inc.** (ICC), whose three members are ICBO, BOCA and SBCCI, headquartered in Falls Church, Virginia, publisher of the *2000 International Building Code (IBC)* [21], the *1998 International One and Two-Family Dwelling Code*, the *2000 International Residential Code (IRC)* and other International codes.

Until recently, the BOCA, SBCCI and ICBO codes tend to be regional in use with the *Uniform Building Code* covering the largest part of the country. The *1998 International One and Two-Family Dwelling Code* replaced the widely used *1995 CABO One and Two Family Dwelling Code*.

In recent years the three model building code bodies (BOCA, SBCCI, and ICBO) agreed to combine their efforts and as a result, the *International Building Code (IBC)* and the *International Residential Code (IRC)* were published early in the year 2000 (see Table 4.1 and Figure 4.1). The purpose of the newly developed IRC and IBC is to replace the existing model building codes with one national code for one- and two-family dwellings and one national code for all other structures.

The National Fire Protection Association (NFPA), located in Quincy, Massachusetts, is presently developing a competitive set of codes, including building, plumbing, mechanical and fire.

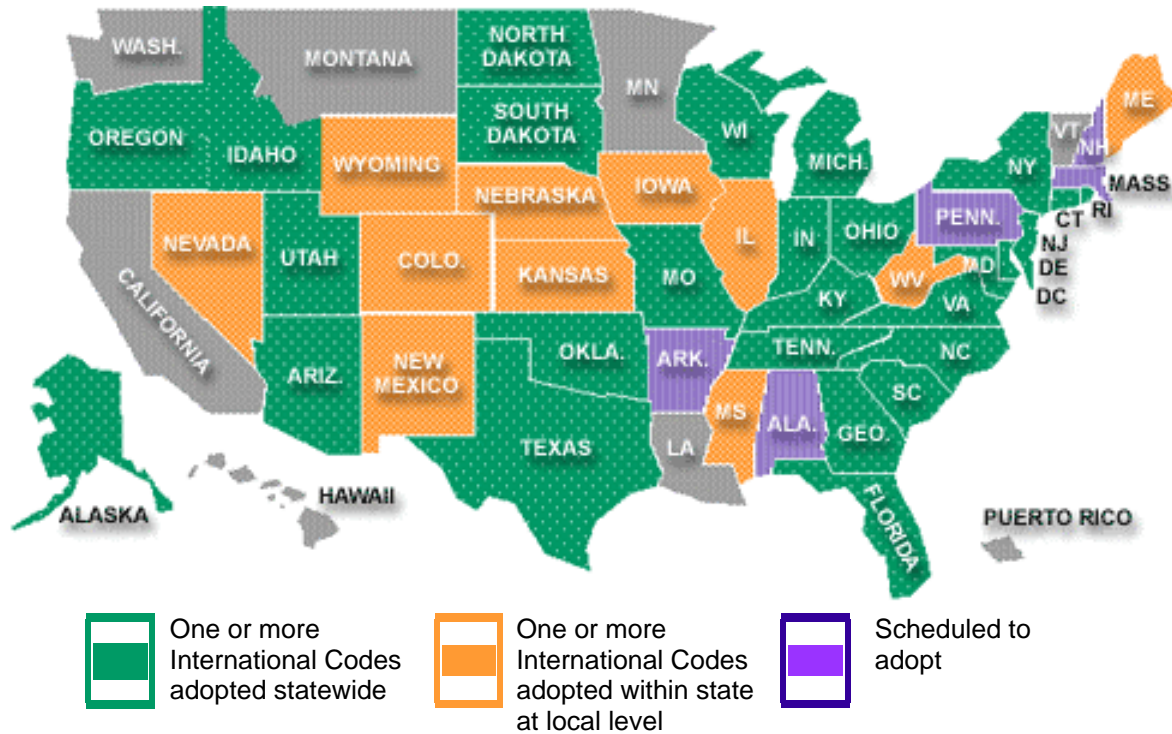

**Figure 4.1 - Geographical Distribution of the I-Codes**  
 (Source: ICC, Falls Church, VA, July 2002, www.intlcode.org)

**Table 4.1 - International Codes - Adoption by State**

State	International Building Code	International Fire Code	International Residential Code	Comments
Alabama	L	L	L	Effective January 2003
Alaska	X	X	L	
Arizona	L	L	L	
Arkansas	A	A	A	Effective September 2003
California				
Colorado	L	L	L	
Connecticut				
Delaware	L		L	
District of Columbia				
Florida				
Georgia	X	X	X	
Hawaii				
Idaho	X	X	X	
Illinois	L	L	L	

Source: International Code Council, Inc. (ICC), Falls Church, VA, July 2002 (www.intlcode.org).  
 A = State wide adoption; X = Effective statewide; L = Adopted by local governments

**Table 4.1 - International Codes - Adoption by State (cont.)**

State	International Building Code	International Fire Code	International Residential Code	Comments
Indiana			X	
Iowa	L	L	L	
Kansas	L*	L	L	IBC accepted for state except for school construction
Kentucky	X		X	
Louisiana				
Maine	L	L	L	
Maryland	X		X	
Massachusetts	A		A	
Michigan	X	L	X	
Minnesota				
Mississippi	L	L	L	
Missouri	L	L	L	State buildings only
Montana				
Nebraska	L	L	L	
Nevada	L	L	L	
New Hampshire	A	L	L	Effective September 2002
New Jersey				
New Mexico	L		L	
New York	X	X	X	
North Carolina	X	X	X	
North Dakota	X	L	X	
Ohio	X	L	X	
Oklahoma	L	L	X*	Mechanical provisions only
Oregon				
Pennsylvania	A	L	A	
Rhode Island	X			
South Carolina	X	X	X	
South Dakota	X			
Tennessee	L	L	L	
Texas	L	L	X	
Utah	X	X	X	
Vermont				
Virginia				
Washington				
West Virginia				
Wisconsin	X			
Wyoming	L	L		

Source: International Code Council, Inc. (ICC), Falls Church, VA, July 2002. ([www.intlcode.org](http://www.intlcode.org))

A = State wide adoption; X = Effective statewide; L = Adopted by local governments

## 4.2.2 Methods of Approval

In principle, manufacturers of new products systems, or assemblies have several avenues for gaining building code recognition, although in practice not all methods may be relevant to a particular situation.

### □ **Evaluation Reports**

Evaluation reports are advisory and not mandatory (the local jurisdiction has the final say on acceptability), however in practice, local building officials rely heavily on these reports in approving or disapproving the use of specific products or methods in their jurisdiction.

An evaluation report can be submitted under one national code or multiple national codes. The National Evaluation Service, Inc. (NES) whose membership includes the Building Officials and Code Administrators, Inc., and SBCCI Public Safety Testing and Evaluation Services, Inc. (SBCCI PST & ESI), issue evaluation report. Until recently it also included ICBO Evaluation Service, Inc. (ICBO ES) which now operates independently.

### □ **Consensus Standards**

A standard is a prescribed set of rules, conditions, or requirements concerned with classification of components, materials, processes, systems, performance, etc. The model building codes place great reliance on the use of standards produced in the private sector. Standards are typically developed by voluntary consensus standard-writing organizations, by accredited committees, by trade associations, and by government.

### □ **Technical Suitability of Products Program**

The Technical Suitability of Products Program (TSPP) was established by Congress under Section 521 of the National Housing Act to assure the successful use of building products, materials, and systems and to make sure that any material, design, or product that is technically suitable would be available for use in HUD housing programs. The relevant HUD housing programs include new homes financed with mortgages insured by the Federal Housing Administration (FHA) or the Veterans Administration (VA).

Technical suitability documents inform HUD Field Offices of Departmental Acceptance of new or nonstandard building products that are generally not covered by existing standards. TSPPs are nationwide in scope.

### □ **Structural Engineering Bulletin (SEB)**

An Engineering Bulletin is an acceptance document by which HUD accepts a specific manufacturer's housing system or subsystem. The two types of engineering bulletins are:

- a. Structural Engineering Bulletin (SEB)
- b. Mechanical Engineering Bulletin (MEB)

SEBs indicate the structural acceptability of systems or subsystems such as modular housing or panelized construction for complete housing units, floor, wall or roof systems. Note that while HUD acceptance offers recognition and legitimacy that may facilitate product acceptance at the local level, it is not a sure substitute for a model code evaluation. Technically it is only required for products used in homes financed with FHA- or VA-insured mortgages, a relatively small part of the market.

## **4.3 Building Classification**

BNBC, UBC and SBC building codes classify structures in accordance with their intended use. Changes were made in the latest editions of the 1997 UBC, 1999 BNBC, and 1999 SBC codes to align themselves with each other and the 2000 IBC. A separate code for one- and two-family dwellings and townhouses using prescriptive provisions was also developed by the ICC titled “International Residential Code” (IRC). The 2000 IRC includes detailed prescriptive provisions for steel floor framing, steel wall framing, and steel roof framing.

The model building codes generally classify buildings according to occupancy, using types such as: residential, business, education, institutional, assembly, storage, mercantile, manufacturing, and hazardous. Within occupancy classifications, codes also consider issues such as whether the residents are elderly, disabled, or confined. Unprotected wood construction for example is generally not permitted in such occupancies as theaters with stages, and some institutions.

### **4.3.1 IBC Use and Occupancy Classification**

The 2000 IBC code is used to define building occupancies and construction types in this report. The 2000 IBC divides buildings into ten Use and Occupancy Classifications with sub-groups under several of the classifications. The 2000 IBC further classifies buildings based on the type of construction. It sets limits for building area and number of stories for each use based on the type of construction with several modifiers based on location on site and fire protection elements. A summary of the IBC residential building classification is presented here.

#### **Residential Group R (Groups R-1 through R-4)**

Includes buildings and portions of buildings used for sleeping accommodations other than Institutional. Group R has four sub-groups as follows:

- R-1: Residential occupancies where the occupants are primarily transient in nature, such as hotels and boarding houses.
- R-2: Residential occupancies containing more than two dwelling units where the occupants are primarily permanent in nature, such as apartment houses and dormitories.
- R-3: Detached one- and two-family dwellings and multiple single-family dwellings (townhouses) not more than three-stories high (R-3 shall comply with the IRC).
- R-4: Buildings for occupancy as residential care/assisted living facilities including more than five but not more than 16 occupants (limited residential care facilities).

Table 4.2 provides examples of the residential building occupancies based on the classification as specified in the IBC.

**Table 4.2 – Assembly Group Occupancy (Based on 2000 IBC)**  
(For a complete listing and limitations, refer to Chapter 3 of the IBC)

Use	Examples
R-1	Transient residential occupancies: Boarding houses, hotels and motels
R-2	Residential dwellings: Apartment houses, monasteries, dormitories, fraternities and sororities
R-3	Adult or child care facilities for less than 5 persons in buildings that do not contain more than 2 dwellings
R-4	Residential care/assisted living facilities having more than 5 but less than 16 occupants

Source: 2000 IBC Section 302.

### 4.3.2 Types of Construction

When addressing fire protection requirements for buildings and other structures, building codes typically include terms such as:

- Fireproof,
- Protected Noncombustible (e.g., steel framing covered with fire protective materials such as gypsum board),
- Unprotected Noncombustible (e.g., exposed steel framing members),
- Fire-Resistive (a term adopted by the National Fire Protection Association to replace “fireproof”; may be noncombustible, but noncombustible materials are not necessarily fire resistive).

Each of the above terms is used based on types of construction as specified in the building codes. The 2000 IBC construction types are summarized in Table 4.3.

**Table 4.3 - Types of Construction (2000 IBC)**

Building Construction Type	Description
I	Constructed of building elements that are of noncombustible materials (combustible materials are permitted in Type I and II buildings in certain conditions)
II	Similar to Type I Buildings
III	Buildings with noncombustible exterior walls and any interior walls
IV	Buildings with noncombustible exterior walls and solid or laminated wood interior elements
V	Buildings with exterior and interior of any material permitted by the code

## 5 Fire and Acoustic Code Requirements

### 5.1 Introduction

Historically, fire is one of the greatest hazards in light-frame residential buildings [22,23]. Building codes in the U.S. have evolved and improved dramatically to protect buildings, their occupants, and adjoining structures from fire. To accomplish this, building codes require that buildings of certain size and type, especially those with high fire risks or high occupancies, be constructed of noncombustible materials such as steel, gypsum, or concrete.

If a fire does break out in a single-family dwelling, the goal is to prevent it from spreading to adjoining structures while extinguishing it quickly. Load bearing members (such as studs and joists) should also be able to support loads in a fire so that the building, or a major part of it, does not collapse prematurely.

Fire-resistance (expressed in units of minutes or hours) is generally required by building codes for the various elements of construction and is normally a function of the building classification, occupancy group and other physical characteristics.

Building regulations also prescribe sound insulation levels for buildings and other structures. Although these sound insulation requirements do not typically apply to individual dwellings (such as single-family homes), occupiers do expect some level of acoustic privacy between rooms. Acoustic insulations are normally required between units of multi-family dwellings, apartments, and other buildings.

It should be recognized that there is a strong relationship between the configuration of floors and walls for both fire and acoustic insulation requirements. In practice, the more severe of these requirements controls the design and construction of floors or walls.

### 5.2 Fire Requirements

The International Building Code (2000 IBC), the Uniform Building Code (1997 UBC), the Southern Building Code (1999 SBC), and the National Building Code (1999 NBBC) provide the fire-resistance and acoustic performance rating requirements for new buildings based on the building occupancy group and construction type. The International Residential Code (2000 IRC), the ICC International One and Two Family Dwelling Code (1998 IOTFDC) and the 1995 CABO provide the fire-resistance and acoustic performance rating requirements for one and two family dwellings and townhomes.

Building codes typically set the acceptable height and area limits of buildings based on the combustion characteristics of the structures. The discussion below is based mainly on the provisions of the model codes that regulate combustible-unprotected type of construction.

**Exterior Wall Construction** – All of the model codes require that exterior walls within short distance from the property line (typically 3-5 feet (915-1524 mm)) be of one-hour construction.



The rating requirements in some of the codes are for exposure from both sides. However, many listed assemblies in the building codes are rated for exposure from one side only.

**Separation Between Two-Family Dwelling Units** – In general, the U.S. model building codes require that units in two-family dwellings be separated by one-hour fire-resistive walls continuous to the underside of the roof sheathing (see 2000 IRC Section R321). A fire-resistance rating of ½ hour is permitted in buildings equipped with an automatic sprinkler system.

**Townhouse Separation** – Each townhouse is typically considered as a separate building that requires a one-hour separation wall (for each building), which is continuous from the foundation to the underside of the roof sheathing, deck, or slab extending the full length of the wall. A single two-hour wall is permitted with some restrictions. The 1995 CABO, 1998 IOTFDC and the 2000 IRC permit a single two-hour wall if no plumbing, mechanical equipment, ducts, or vents are in the wall (electrical wiring and metallic electrical outlet boxes are permitted.) Alternatively, the 1995 CABO and 2000 IRC permit each unit to have a separate one-hour wall. The 1999 SBC allows plumbing, ducts, and wires in a single two-hour wall if materials and methods meet specific minimum requirements.

**Multifamily Building Separation** – The 2000 IRC, 1998 IOTFDC and 1995 CABO do not address multifamily construction. In both the 1999 BNBC and 1997 UBC, “area separation walls” with a minimum fire-resistance rating of two hours separate multifamily buildings. They work as follows: Each code stipulates the maximum allowable floor area for a multifamily building. If the floor area of a planned building exceeds the limits, two-hour fire-rated walls can be used to subdivide the building into two or more buildings with floor areas that meet the limits. The SBC requires four-hour rated walls between buildings.

**Multifamily Unit Separation** – The three major model codes and the 2000 IBC require one-hour rated floor/ceiling and wall construction between separate dwelling units within a building. Some codes lower this limit to ½ hour in exchange for a specified sprinkler installation.

**Firestopping** – Requirements for firestoppings vary among the model codes. Places where firestopping is commonly required include: concealed spaces in stud walls and partitions, and furred spaces at the ceiling and floor levels; interconnections between concealed vertical and horizontal spaces; concealed spaces between stair stringers at the top and bottom of the run; and at openings around vents, pipes, ducts, chimneys and fireplaces at ceilings and floor levels.

**Draft stop** – Requirements for draft stops also are varied. A common requirement is for installation in the concealed spaces of a floor/ceiling assembly with usable space above and below it, so that the concealed space is divided into approximately equal areas not exceeding either 1000 or 500 square feet (92.9 or 46.45 m<sup>2</sup>), depending on the code. Draft stop is also required in some of the codes in attic spaces of multifamily buildings.

It should be noted that the installation of approved residential fire sprinkler systems could affect some of the above requirements. Further, penetration of fire-rated assemblies like firewalls is also addressed by the codes, but this is not unique to steel framed structures.



## 5.2.1 2000 IBC Fire Requirements

### □ Fire-Resistance Requirements

All buildings (new, altered or extended) are typically classified in one of the five construction types defined in Section 4.3 of this report. Fire separation requirements are shown in Table 5.1 for Residential buildings. Fire-resistance ratings of building elements are shown in table 5.2. Fire-resistance ratings of exterior walls are shown in Table 5.3.

Firewalls (party walls) provide complete separations between attached buildings. Firewalls are required to have sufficient structural stability under fire conditions to allow collapse of construction on either side without collapse of the wall for the duration of time indicated by the required fire-resistance rating. Firewalls can be constructed of any approved non-combustible materials (exception Buildings of Type V construction). Portions of buildings are typically individually classified as to use and are completely separated from adjacent areas by fire barrier walls as shown in Table 5.4.

**Table 5.1 - Required Separation Between Dwelling Units (Hours)<sup>a</sup>**

Use	R-1	R-2	R-3	R-4	U
R-1	2	2	2	3	1
R-2	-	2	2	3	1
R-3	-	-	2	3	1 <sup>b</sup>
R-4	-	-	2	3	1 <sup>b</sup>
U	-	-	-	-	1

Source: Table 302.3.3 of the 2000 IBC.

a. Private garage shall be separated from the residence and its attic area by means of minimum ½” (12.7 mm) gypsum board applied to the garage side. Openings from a private garage directly into a sleeping room are not permitted.

b. Separation is not required between a Group R-3 and Group U carport if the carport is entirely open on two sides and no occupancy above it.

**Table 5.2 – Fire-Resistance Rating Requirements for Building Elements (Hours)**

(For detailed information and exceptions, refer to Table 601 of the 2000 IBC)

Building Element	Type I		Type II		Type III		Type VI	Type V	
	A	B	A <sup>d</sup>	B	A <sup>d</sup>	B	HT	A <sup>d</sup>	B
Structural Frame <sup>a</sup> Including columns, girders, trusses	3 <sup>b</sup>	2 <sup>b</sup>	1	0	1	0	HT	1	0
Bearing walls									
Exterior <sup>f</sup>	3	2 <sup>b</sup>	1	0	2	2	2	1	0
Interior	3 <sup>b</sup>	2 <sup>b</sup>	1	0	1	0	1/HT	1	0
Nonbearing walls and partitions	See Table 5.3								
Exterior									
Interior <sup>e</sup>									
Floor construction Including supporting beams and joists	2	2	1	0	1	0	HT	1	0
Roof construction Including supporting beams and joists	1 ½	1 <sup>c</sup>	1 <sup>c</sup>	0 <sup>c</sup>	1 <sup>c</sup>	0	HT	1 <sup>c</sup>	0

**Source: Table 601 of the 2000 IBC.**

- a. Members of floor and roof panels that are not connected to the columns are considered secondary members and not part of the structural frame.
- b. Roof supports: Fire-resistance ratings of structural frame and bearing walls are permitted to be reduced by 1 hr where supporting a roof only.
- c. See additional requirements and exceptions in IBC Table 601.
- d. An approved automatic fire sprinkler system is allowed to be substituted for 1 hr fire-resistance rated construction. This is not allowed for exterior walls.
- e. See 2000 IBC Section 602.4.6 for additional requirements for nonbearing walls in Type IV construction.
- f. Not less than the fire-resistance rating on fire separation distance.

**Table 5.3 – Fire-Resistance Rating Requirements for Exterior Walls Based on Fire Separation Distance (Hours)<sup>a</sup>**

(For detailed information and exceptions, refer to Table 602 of the 2000 IBC)

Fire Separation Distance (feet)	Type of Construction	R <sup>b</sup>	U
< 5 <sup>c</sup>	All	1	1
≥ 5	I-A	1	1
< 10	Others	1	1
≥ 10	I-A, I-B	1	1
< 30	II-B, V-B, Others	0	0
		1	1
≥ 30	All	0	0

**Source: Table 602 of the 2000 IBC.**

- a. Load bearing exterior walls are also required to comply with the fire ratings requirements of 2000 IBC Table 6.30.
- b. Group R-3 and Group U when used as accessories to Group R-3 are not required to have a fire-resistance rating where fire separation distance is 3 feet (914 mm) or more.
- c. See 2000 IBC Section 503.2 for party walls.

**Table 5.4 – Fire Wall Fire-Resistance Ratings**

Group	Fire-Resistance Rating (hours)
R-1	3
R-2	3
R-3	2
R-4	2
U	3 <sup>a</sup>

Source: Table 705.4 of the 2000 IBC.

a. Walls shall be not less than 2-hour fire-resistance rated when separating buildings of Type II or V construction.

□ **Automatic Sprinkler Systems**

Automatic fire sprinkler systems are required as described in Table 5.5 below:

**Table 5.5 – Required Automatic Fire Sprinkler (AFS) Per 2000 IBC**

Use	Requirements
R-1	Required in all buildings. Can be substituted for a residential sprinkler system (NFPA 13R).
R-2	Required in buildings more than 2 stories high or having more than 16 dwelling units. Can be substituted for a Residential sprinkler system (NFPA 13R) for buildings up to four stories in height.
R-3	Not required. A fire-resistance rating of ½ hour is permitted for two-family dwellings equipped throughout with an automatic sprinkler system.
R-4	Required in buildings with more than 8 occupants.
U	Not required.

## 5.2.2 BOCA Fire-Resistance Requirements

All buildings (new, altered or extended) are typically classified in one of the five construction types defined in Section 4.3 of this report. Buildings shall have a fire-resistant rating as shown in Table 5.6.

**Table 5.6 – Fire-Resistive Requirements for Structural Components Per the 1999 BNBC<sup>1</sup>**

(For detailed information and exceptions, refer to Table 602 of the 1999 BNBC)

Framing Member	Type 1		Type 2			Type 3		Type 4	Type 5	
	Noncombustible		Noncombustible			Ordinary		Heavy	Wood Frame	
	Protected (hours)		Protected (hours)	Unprotected (hours)		Protected (hours)	Unprotected (hours)	Timber (hours)	Protected (hours)	Unprotected (hours)
	1A	1A	2B	2B	2C	3A	3B	4	5A	5B
Exterior Bearing Walls	4	3	2	1	0	2	2	2	1	0
Interior Bearing Walls	4	3	2	1	0	1	0	1	1	0
Floors	3	2	1-1/2	1	0	1	0	<sup>(3)</sup>	1	0
Roof (<15' high)	2	1-1/2	1	1	0	1	0	<sup>(3)</sup>	1	0

<sup>1</sup> The above fire-resistance ratings are based on conditions such as maximum heights and areas. Increases and reductions in these ratings for specified design considerations are covered in the code.

<sup>2</sup> 4x6 roof, 6x10 floor, 6x8 col. (roof), 8x8 col. (floor).

<sup>3</sup> 3" or 4" (76 or 102 mm) set on edge plus 1" (25.4 mm) flooring (or 15/32" plywood) (12 mm).

### 5.2.3 UBC Fire-Resistance Requirements

All buildings (new, altered or extended) are classified in one of five construction types similar to the ones defined in Section 4.3 of this report. Buildings elements shall have a fire-resistant rating as shown in Table 5.7.

**Table 5.7 – Fire-Resistive Requirements for Structural Components Per the 1997 UBC<sup>1</sup>**

(For detailed information and exceptions, refer to Table 600 of the 1997 UBC)

Building Element	Type I	Type II			Type III		Type IV	Type V	
	Noncombustible (hours)				Combustible (hours)				
	Fire-Resistive	Fire-Resistive	1 Hr.	N	1 Hr.	N	Heavy Timber (H.T.)	1 Hr.	N
Exterior bearing walls	4 Sec. 602.3.1	4 Sec. 603.3.1	1	N	4 Sec. 604.3.1	4 Sec. 602.3.1	4 Sec. 605.3.1	1	N
Interior bearing walls	3	2	1	N	1	N	1	1	N
Exterior non-bearing walls	4 Sec. 602.3.1	4 Sec. 603.3.1	1 Sec. 603.3.1	N	4 Sec. 604.3.1	4 Sec. 602.3.1	4 Sec. 605.3.1	1	N
Floors and floor-ceilings	2	2	1	N	1	N	H.T.	1	N
Roofs and roof ceiling	2 Sec. 602.5	1 Sec. 603.5	1 Sec. 603.5	N	1	N	H.T.	1	N

<sup>1</sup> N indicates No general requirements for fire-resistance.

### 5.2.3 SBC Fire-Resistance Requirements

All buildings (new, altered or extended) are classified in one of five construction types similar to the ones defined in Section 4.3 of this report. Buildings elements shall have a fire-resistance rating as shown in Table 5.8.

**Table 5.8 – Fire-Resistive Requirements for Structural Components Per the 1999 SBC<sup>a</sup>**  
(For detailed information and exceptions, refer to Table 600 of the 1997 SBC)

Building Element	Fire-Resistance Rating (Hours)								
	Type I	Type II	Type III	Type IV		Type V		Type VI	
				1-Hour Protected	Unprot.	1-Hour Protected	Unprot.	1-Hour Protected	Unprot.
Party and Fire Walls	4	4	4	4	4	4	4	4	4
Interior Bearing Walls									
•Supporting columns, other bearing walls or more than one floor	4	3	2	1	NC	1 (b)	0 (b)	1	0
•Supporting one floor only	3	2	1	1	NC	1	0	1	0
•Supporting roofs only	3	2	1	1	NC	1	0	1	0
Interior Non-bearing Partitions	See Standard Building Code Sections 609.2, 704.1, 704.2, and 705.2								
Floor & Floor/ Ceiling Assemblies	3	2	See 605 H	1	NC	1	0	1	0
Roofs & Roof/ Ceiling Assemblies	1.5 (c,e)	1 (c,e,f)	See 605 H	1 (c,e)	NC (c)	1	0	1	0
Bearing Walls and gable end roof (f, g)									
Exterior Walls	4	3	3	2	1	3	3	1	1
Interior Walls (0-3' distance from common property line)	3	3	3	2	1	3	3	1	1

NC – Non-combustible, H – Heavy Timber Sizes.

<sup>a</sup> Refer to Table 600 of SBC for detailed information and exception.

<sup>b</sup> Use of combustible construction in interior bearing partitions is limited to building with two floors and roof only.

<sup>c</sup> Approved fire-retardant treated wood may be used in buildings not over two stories high..

<sup>d</sup> In one-story buildings structural members of heavy timber sizes may be used as an alternate to unprotected structural roof members.

<sup>e</sup> In buildings of Group R occupancies, the roof or roof/ceiling assembly fire-resistance may be omitted where every part of the roof structural members have a clear height of 20 feet (6096 mm) or more above any floor, mezzanine or balcony..

<sup>f</sup> The use of combustible construction of interior bearing partitions is limited to the support of 2 floors and roof.

<sup>g</sup> For certain occupancies, the fire rating may be reduced to 1 hr. with automatic sprinkler system.

## 5.2.4 IRC, CABO and ICC IOTFDC Fire Requirements

Table 5.9 provides a summary comparison between the International Residential Code (2000 IRC), the One and Two-Family Dwelling Code (CABO 1995) and the International One- and Two-Family Dwelling Code (ICC 1998) fire-resistance requirements.

**Table 5.9 – Fire-Resistant Separation Requirements in the IRC, CABO & OTFDC**

Building Element	2000 IRC	1995 CABO/ 1998 IOTFDC
Exterior Wall Construction	Section R302 requires that exterior walls with a fire separation less than 3 feet (914 mm) to have not less than 1-hour fire resistive rating with exposure from both sides. Projections must not extend more than 12 in. (305 mm) into areas where openings are prohibited. Projections extending into the fire separation distance must not have less than 1-hour fire resistive construction on the underside. Exceptions: Tool and storage sheds, playhouses, and similar structures are exempt.	Section 302.1 requires exterior walls located less than 3-feet (914 mm) from property lines to have not less than 1-hour fire resistive rating (rated for exposure from both sides). Projections must not extend more than 12 in. (305 mm) into areas where openings are prohibited.
Draft Stop	Section R502.12 requires draft stops to be installed for usable spaces both above and below the concealed space of a floor/ceiling assembly, so that the area of the concealed space does not exceed 1000 square feet (305 m <sup>2</sup> ). The draft stop must divide the concealed space into approximately equal areas. When the assembly is enclosed by a floor membrane above and a ceiling membrane below draft stop must be provided in floor/ceiling assemblies for the following conditions: <ol style="list-style-type: none"> <li>1. Suspended ceilings under the floor framing.</li> <li>2. Truss-type open-web or perforated members floor framed construction.</li> </ol>	Section 502.11 indicates that when there is usable space above and below a concealed space in a floor/ceiling assembly, draft stops must be installed so that the area of the concealed space does not exceed 1000 square feet (92.9 m <sup>2</sup> ). The draft stop must divide the concealed space into approximately equal areas. It must be provided in floor/ceiling assemblies when: <ol style="list-style-type: none"> <li>1. The ceiling is suspended under the floor framing, or</li> <li>2. Floor framing constructed with truss-type open-web or perforated members, or</li> <li>3. A floor membrane above and a ceiling membrane below enclose the assembly.</li> </ol>
Two-Family Dwelling Separation	Section R321.1 requires dwelling units in two-family dwellings to be separated from each other by wall and/or floor assemblies of not less than 1-hour fire-resistive rating. Fire-resistive floor-ceiling and wall assemblies must extend to and be tight against the exterior wall, and wall assemblies must extend to the underside of the roof sheathing.	Section 320.1: Dwelling units in two-family dwellings must be separated from each other by wall and/or floor assemblies of not less than 1-hour fire-resistive rating. Fire-resistive floor-ceiling and wall assemblies must extend to and be tight against the exterior wall, and wall assemblies must extend to the underside of the roof sheathing.

**Table 5.9 – Fire-Resistant Separation Requirements in the IRC, CABO & OTFDC (cont.)**

<b>Building Element</b>	<b>2000 IRC</b>	<b>1995 CABO/ 1998 IOTFDC</b>
Townhouse Separation	<p>Section R321.2 requires each townhouse to be constructed as a separate building with a 1-hour fire-rated wall assembly (separating the units).                      Exception: A common 2-hour fire-resistive wall is allowed if the cavity of the wall does not contain plumbing or mechanical equipment, ducts, or vents. Electrical installations are limited to electrical wires installed in raceways and electrical outlet boxes.</p>	<p>Section R320.2: Each townhouse must be constructed as a separate building with a 1-hour fire-rated wall assembly separating them.                      Exception: A common 2-hour fire-resistive wall is allowed if the cavity of the wall does not contain plumbing or mechanical equipment, ducts, or vents. Electrical installations are limited to electrical wires installed in raceways and electrical outlet boxes.</p>
Firestopping (fireblocking)	<p>Section R602.8 indicates that firestopping must be installed to cut off all concealed vertical and horizontal draft openings and form a fire barrier between stories and between a top story and roof space. Section R602.8 provides additional requirements for wood homes (locations of fireblocking).</p>	<p>Section 602.7 indicates that firestopping must be installed to cut off all concealed vertical and horizontal draft openings and form a fire barrier between stories and between a top story and roof space. Section 602.7 provides additional requirements for wood homes (locations of fireblocking).</p>



### 5.3 Acoustical Requirements

Wall and floor-ceiling assemblies separating dwelling units are typically required to provide sound insulation for walls, and both airborne and impact sound insulation for floor-ceiling assemblies. Table 5.10 summarizes the minimum STC and IIC requirements as stipulated in the US building codes.

**Table 5.10 - STC and IIC Requirements Selected Codes**

Building Code <sup>1</sup>	Use Group <sup>1</sup>	Code Reference Section	STC (FSTC) Requirements (Air-Borne Sound Insulation)		IIC Requirements (Impact Sound Insulation)
			Walls	Floor/ Ceilings	Floor/Ceilings
BOCA [19]	R	Section 1214.0	45	45	45
UBC [18]	R	Appendix Chapter 12 Section 1208	50 (45 if field tested)	50 (45 if field tested)	50 (45 if field tested)
SBC [20]	-	-	-	-	-
2000 IBC	Dwelling Units	Section 1206	50 (45 if field tested)	50 (45 if field tested)	50 (45 if field tested)
CABO [3]	Between Dwelling Units	Section 320	45	45	45
ICC IOTFDC [17]	Between Dwelling Units	Section 320	45	45	45
IRC [4]	Between Dwelling Units or Between Dwelling Units and Public or Service Areas	Appendix K	45	45	45
California Title 24 [54]	Party Walls and Between Floors of Multi-Family Dwellings		50 (45 if field tested)	50 (45 if field tested)	50 (45 if field tested)

<sup>1</sup> Use Group R includes all structures in which families or households live, or in which sleeping accommodations are provided, excluding those classified as institutional occupancies.

## 5.4 Determination of Fire and Acoustic Ratings

### 5.4.1 Determination of Fire-Resistance Ratings

The U.S. model building codes, except the UBC, recognize the ASTM E119 [7] test method as the standard test method to establish the fire rating of assemblies. The UBC cites its own standard [24]. Code bodies typically accept fire tests conducted by recognized laboratories (such as Underwriters Laboratories, UL) or organizations (such as Factory Mutual). Table 5.11 summarizes the most widely recognized test methods.

**Table 5.11 - Test Methods for Fire-Rated Steel Assemblies**

Standard	Title	Description
ASTM E119 [7]	Standard Test Methods for Fire Tests of Building Construction and Materials	Test methods described in this fire-test-response standard are applicable to assemblies of masonry units and to composite assemblies of structural materials for buildings, including bearing and other walls and partitions, columns, girders, beams, slabs, and composite slab and beam assemblies for floors and roofs. They are also applicable to other assemblies and structural units that constitute permanent integral parts of a finished building.
ASTM E814 [25]	Standard Test Method for Fire Tests of Through-Penetration Fire Stops	Applicable to through-penetration fire stops of various materials and construction. Fire stops are intended for use in openings in fire-resistive walls and floors that are evaluated in accordance with Test Methods E119.
Factory Mutual [26]	Insulated Wall Construction	Intended for non-load bearing walls (curtain walls) having relatively low fire endurance properties and not intended as hourly rated fire barriers. This test method can be modified to evaluate the performance of partition walls.
Factory Mutual [27]	Insulated Steel Deck Roofs	Intended for the evaluation of commercial type construction such as steel trusses.
International Standard ISO 834 [28]	Fire-resistance Tests of Elements in Building Construction	Provides the means to evaluate structural elements of building construction (walls, partitions, columns, beams, and floors) during a predetermined fire test exposure. The assemblies are assigned ratings based upon the duration of the test and the ability of the assembly to exhibit fire-resistance properties
UBC Standard 7-1 [24]	Standard for Fire Tests of Building Construction and Materials	This test method is based on ASTM E119.

**Table 5.11 - Test Methods for Fire-Rated Steel Assemblies (cont.)**

Standard	Title	Description
UL Standard UL 1479 [29]	Fire Tests of Through-Penetration Firestops	This test method is based on ASTM E814.
UL Standard UL 263 [30]	Standard for Fire Tests of Building Construction and Materials	This test method is based on ASTM E119.
UL Standard UL 2079 [31]	Tests for Fire-Resistance of Building Joint Systems	Used to test joint systems and firestop systems which are intended to prevent the spread of fire through openings between or within fire resistive assemblies.
Intertek Testing Services / Warnock Hersey BU-606 [32]	Fire Rating & Certification for Products & Systems	Test systems (such as wall assemblies, fire doors and frames, and floor/roof/ceiling) as effective fire barriers and to determine the surface burning characteristics of building material, including flame spread, and smoke developed during exposure to fire.

#### 5.4.2 Determination of STC and IIC Ratings

The U.S. model building codes recognize the ASTM E90 [33] test method as the standard method for determining the STC rating for an assembly. Table 5.12 summarizes the most widely recognized test methods.

**Table 5.12 - Test Methods for Acoustical Insulation**

Standard	Title	Description
ASTM E90 <a href="http://www.astm.org">www.astm.org</a> [33]	Standard Test Method for Laboratory Measurement of Airborne Sound Transmission Loss of Building Partitions and Elements	This test method covers the laboratory measurement of airborne sound transmission loss of building partitions such as walls of all kinds, operable partitions, floor-ceiling assemblies, doors, windows, roofs, panels, and other space-dividing elements.
ASTM E 336 <a href="http://www.astm.org">www.astm.org</a> [34]	Standard Test Method for Measurement of Airborne Sound Insulation in Buildings	This test method covers a procedure to determine the noise reduction between two rooms under field conditions. The evaluation may be made including all paths by which sound is transmitted or attention may be focused only on the dividing partition. The word "partition" in this test method includes all types of walls, floors, or any other boundaries separating two spaces. The boundaries may be permanent, operable, or movable.

**Table 5.12 - Test Methods for Acoustical Insulation (cont.)**

Standard	Title	Description
ASTM E413 <a href="http://www.astm.org">www.astm.org</a> [35]	Standard Classification for Rating Sound Insulation	This classification provides methods of calculating single-number acoustical ratings for laboratory and field measurements of sound transmission obtained in one-third octave bands. The method may be applied to laboratory or field measurements of the sound transmission loss of a partition in which case the single-number ratings are called sound transmission class (STC) or field sound transmission class (FSTC), respectively. The method may also be applied to laboratory and field measurements of the sound isolation between two spaces, in which case the single-number ratings are called the noise isolation class (NIC) or normalized noise isolation class (NNIC).
ASTM E492 <a href="http://www.astm.org">www.astm.org</a> [36]	Standard Test Method for Laboratory Measurement of Impact Sound Transmission Through Floor-Ceiling Assemblies Using the Tapping Machine	This test method covers the laboratory measurement of impact sound transmission of floor-ceiling assemblies using a standardized tapping machine.
International Standard ISO 140-4 [11]	Acoustics – Measurement of Sound Insulation in Buildings and of Building Elements	Part 4 of this standard describes the test method for field measurements of airborne sound insulation between rooms and Part 6 describes the test method for laboratory impact sound insulation of building elements.

## **6 Fire and Acoustic Details - Industry Literature**

### **6.1 Introduction**

The application of fire and acoustic requirements in residential construction are minimal and generally only relate to common walls between dwellings. However, in recent years some trends have occurred to change the scope of the fire and acoustic performance of cold-formed steel framing as it is being used more in multi-story buildings and apartments. There also has been an increased acceptance of cold-formed steel framing in commercial applications. Furthermore, there has been a trend towards increased housing densities. This coupled with changes in lifestyles has led to a demand for better sound insulation of dwellings (such as internal walls to have sound insulation to isolate louder rooms.)

As a result more industry literature is becoming available on:

- fire performance of cold-formed steel framed wall systems in both load bearing and non-load bearing applications. Information about the fire performance of cold-formed steel floor systems is, however, more limited.
- acoustic performance of a range of wall and floor systems including STC values in excess of those required in most building codes, and guides for sound insulation of internal walls within a dwelling.

### **6.2 Fire-Rated Assemblies**

Design information and details on fire-resistance and fire-ratings of cold-formed steel assemblies are scarce. However, the Gypsum Association, Underwriters Laboratories, Inc., Factory Mutual, and Intertek Testing Services (Warnock Hersey) are the main sources of information on this subject. Other organizations, such as the Brick Institute of America, and the American Iron and Steel Institute (AISI) have limited information, details, and design information. Table 6.1 contains a detailed list of publications and technical data that are currently available.

**Table 6.1 - Summary of Industry Literature**

Source of Information	Title	Description
American Iron and Steel Institute AISI FT-901 [37] <a href="http://www.steel.org">www.steel.org</a>	Fire-Resistance Ratings of Load Bearing Steel Stud Walls With Gypsum Wallboard Protection With or Without Cavity Insulation	<ul style="list-style-type: none"> <li>This pamphlet summarizes some AISI tests of gypsum wallboard-clad load-bearing steel stud walls.</li> </ul>
American Iron and Steel Institute (AISI) [38] <a href="http://www.steel.org">www.steel.org</a>	Fire-Resistance Steel-Frame Construction	<ul style="list-style-type: none"> <li>Provides an overview of fire protection requirements, methods, and materials. Rated assemblies are included for both residential and commercial walls, floors, and roof decks.</li> </ul>
American Iron and Steel Institute (AISI) [39] <a href="http://www.steel.org">www.steel.org</a>	Designing Fire Protection for Steel Trusses	<ul style="list-style-type: none"> <li>This publication discusses methods of protecting three types of truss systems.</li> </ul>
Brick Institute of America [40] <a href="http://www.bia.org">www.bia.org</a>	Engineering and Research Digest	<ul style="list-style-type: none"> <li>This publication presents information on UL listed steel stud/brick veneer walls.</li> </ul>
	Technical Notes No. 16B, Calculated Fire-resistance	<ul style="list-style-type: none"> <li>Provides information on steel-frame, brick veneer wall construction fire ratings.</li> </ul>
Factory Mutual [27] [43]	1-1 Loss Prevention Data Firesafe Building Construction and Materials 1-28 Insulated Steel Deck 1-31 Metal Roof Systems	<ul style="list-style-type: none"> <li>Series of data sheets addressing fire-rated assemblies. While these data sheets are geared towards commercial and industrial applications, they also contain some information applicable to residential construction.</li> </ul>
	Specification Tested Products Guide	<ul style="list-style-type: none"> <li>Contains a limited number of fire-rated light-gauge steel assemblies that were tested in accordance with ASTM E119.</li> </ul>
Gypsum Association [42] <a href="http://www.gypsum.org">www.gypsum.org</a>	Gypsum Systems Fire-resistance Design Manual – Sound Control	<ul style="list-style-type: none"> <li>Systems in this manual utilize gypsum products to provide fire-resistance to walls, partitions, floors, ceilings, roof-ceilings, columns, beams, girders, and trusses. Fire-rated assemblies in this manual are classified in accordance to use and fire-resistance rating.</li> <li>Provides sound transmission class (STC) ratings of steel walls, partitions, and floor-ceiling systems that utilize gypsum products.</li> </ul>

**Table 6.1 - Summary of Industry Literature (cont.)**

Source of Information	Title	Description
Intertek Testing Services / Warnock Hersey [43] <a href="http://www.etlsemko.com">www.etlsemko.com</a>	Directory of Listed Products	<ul style="list-style-type: none"> <li>Contains construction details for a wide variety of fire-rated proprietary steel floor/ceiling assemblies.</li> </ul>
Los Angeles Department of Building and Safety [44] <a href="http://www.ladbs.org">www.ladbs.org</a>	Sound Rated Partitions and Floor-Ceiling Construction	<ul style="list-style-type: none"> <li>Contains steel and wood fire-rated assemblies with STC and IIC ratings of 50.</li> </ul>
Metal Lath/Steel Framing Association [45]	Technical Bulletin “One-Hour Floor /Ceiling Fire-resistance Test” and “Two-Hour Floor/Ceiling Fire-Resistance Test”	<ul style="list-style-type: none"> <li>These bulletins present the results of specific fire tests.</li> </ul>
National Bureau of Standards [46] <a href="http://www.fire.nist.gov/">www.fire.nist.gov/</a>	Report BMS92 Fire-Resistance Classifications of Building Constructions	<ul style="list-style-type: none"> <li>Provides an overview of fire protection requirements, methods, and materials. Rated assemblies are included for both residential and commercial walls, floors, and roofs.</li> </ul>
National Bureau of Standards [47] <a href="http://www.fire.nist.gov/bfrlpubs/fire89/art004.html">www.fire.nist.gov/bfrlpubs/fire89/art004.html</a>	Report TRBM44 Fire-Resistance and Sound Insulation Ratings for Walls, Partitions and Floors	<ul style="list-style-type: none"> <li>This document gives the fire-resistance and sound-insulation ratings of walls, partitions, and floors. The ratings are applicable to walls and floors in residential and other types of buildings.</li> </ul>
Owens Corning [48] <a href="http://www.owenscorning.com">www.owenscorning.com</a>	Extruded Polystyrene Insulation Foamular Commercial Steel Stud System	<ul style="list-style-type: none"> <li>Contains information and construction details for a proprietary system consisting of steel framed/brick veneer walls that are routinely specified in commercial and multi-family residential construction. The Foamular Extruded Polystyrene Insulation is a part of fire-resistance rated steel framing/masonry veneer, non-load bearing exterior wall assembly. The system was tested in accordance with ASTM E119 and provides a 3-hour fire rating</li> </ul>
Underwriters Laboratories Inc. (UL) [49] <a href="http://www.ul.com">www.ul.com</a>	Fire Resistance Directory—Volumes I and II	<ul style="list-style-type: none"> <li>Contains the most extensive listing of fire-rated assemblies (Vol. I) and firestop penetrations (Vol. II). The ratings are categorized by material and usage. Listed fire-resistive assemblies were tested in accordance with ASTM E119.</li> </ul>

**Table 6.1 - Summary of Industry Literature (cont.)**

Source of Information	Title	Description
US Department of Housing and Urban Development (HUD) [50] <a href="http://www.huduser.org">www.huduser.org</a>	Fire Ratings of Archaic Materials and Assemblies	<ul style="list-style-type: none"> <li>• Compilation of fire-ratings from earlier sources for a wide variety of materials and assemblies found in buildings from the nineteenth to the mid-twentieth centuries. It also provides methods for calculating the fire-resistance of general classes of archaic materials and assemblies for which no documentation can be found.</li> </ul>

Table 6.2 summarizes the contents of the Gypsum Association’s Fire-resistance Design Manual. Table 6.3 provides a summary of the UL’s, Gypsum Association’s, and Factory Mutual’s fire ratings that are applicable to residential construction.

**Table 6.2 - Fire-Resistance Design Manual-Gypsum Systems**

System Description	Fire Rating	
	1 Hour	2 Hours
Interior Partitions	✓	✓
Chase Walls	✓	✓
Exterior Walls	✓	✓
Metal Clad Exterior Walls	✓	✓
Party Walls		✓
Floor-Ceiling Assembly-Steel Frame-Concrete Slab	✓	✓
Floor-Ceiling Assembly-Steel Frame-Wood Floor	✓	-
Steel Columns with Metal studs	-	✓
Beams and Girders	✓	✓



**Table 6.3 – Fire Ratings of Tested Cold-Formed Steel Assemblies**

Source <sup>1</sup>	Load-Bearing Walls		Non load-Bearing Walls	
	1-HR	2-HR	1-HR	2-HR
UL	✓	✓	✓	✓
GA	✓	✓	✓	✓
FM	✓	✓	✓	✓
HUD	-	-	✓	✓
	Floors/Ceilings		Roof-Ceilings	
	1-HR	2-HR	1-HR	2-HR
UL	✓	✓	✓	✓
GA	✓	✓	-	-
FM	✓	✓	✓	✓
HUD	✓	✓ <sup>2</sup>	-	-

<sup>1</sup> UL denotes Underwriters Laboratories Inc.; GA denotes Gypsum Association; FM denotes Factory Mutual; HUD denotes US Department of Housing and Urban Development.

<sup>2</sup> Listed fire rating is 1-1/2 HR.

### 6.3 Acoustic Assemblies

Design information and details on sound insulation of steel assemblies are scarce. However, the Gypsum Association, Factory Mutual, and Intertek Testing Services (Warnock Hersey) are the main sources of information on this subject. Other organizations, such as the Brick Institute of America, and the American Iron and Steel Institute (AISI) have limited information, details, and design information. Table 6.4 contains a detailed list of publications and technical data that are currently available.

**Table 6.4 - Summary of Industry Literature**

Source of Information	Title	Description
Brick Institute of America [40] <a href="http://www.bia.org">www.bia.org</a>	Engineering and research Digest	<ul style="list-style-type: none"> <li>This publication presents information on UL listed steel stud/brick veneer walls.</li> </ul>
	Technical Notes No. 16B, Calculated Fire-resistance	<ul style="list-style-type: none"> <li>Provides information on steel-frame, brick veneer wall construction fire ratings.</li> </ul>
California Department of Health Services [51]	Catalog of STC and IIC Ratings for Wall and Floor/Ceiling Assemblies	<ul style="list-style-type: none"> <li>Provides comprehensive set of sound transmission class (STC) ratings for steel walls and floor/ceiling assemblies.</li> </ul>
Gypsum Association [42] <a href="http://www.gypsum.org/securepubs/download.asp">www.gypsum.org/securepubs/download.asp</a>	Gypsum Systems Fire-resistance Design Manual – Sound Control	<ul style="list-style-type: none"> <li>Systems in this manual utilize gypsum products to provide fire-resistance to walls, partitions, floors, ceilings, roof-ceilings, columns, beams, girders, and trusses. Fire-rated assemblies in this manual are classified in accordance to use and fire-resistance rating.</li> <li>Provides sound transmission class (STC) ratings of steel walls, partitions, and floor-ceiling systems that utilize gypsum products.</li> </ul>
Johns Manville [52] <a href="http://www.jm.com">www.jm.com</a>	Sound Shield for Steel-Framed Construction	<ul style="list-style-type: none"> <li>STC ratings for single and double layer partition walls.</li> </ul>
Los Angeles Department of Building and Safety [44] <a href="http://www.ladbs.org">www.ladbs.org</a>	Doc. No. P/BC 2001-69 Sound Rated Partitions and Floor-Ceiling Construction	<ul style="list-style-type: none"> <li>Contains steel and wood fire-rated assemblies with STC and IIC ratings of 50.</li> </ul>
North American Insulation Manufacturers Association [53] <a href="http://www.naima.org">www.naima.org</a>	Sound Control for Commercial and Residential Buildings	<ul style="list-style-type: none"> <li>Contains recommendations for steel and other assemblies using fiberglass insulation to provide quality noise control.</li> </ul>
US Department of Housing and Urban Development (HUD) [58] <a href="http://www.huduser.org">www.huduser.org</a>	Noise Assessment Guidelines	<ul style="list-style-type: none"> <li>These handbooks have been prepared to serve as a basic reference document for for implementing HUD's noise policy. It brings together in one place all the various reports, informational papers, and other items that have been put out by HUD over the past several years.</li> </ul>
US Department of Housing and Urban Development (HUD) [59] <a href="http://www.huduser.org">www.huduser.org</a>	The Noise Handbook	
US Department of Housing and Urban Development (HUD) [9] <a href="http://www.huduser.org">www.huduser.org</a>	A Guide to Airborne, Impact, and Structure Borne - Noise Control in Multifamily Dwellings	<ul style="list-style-type: none"> <li>Incorporates a broad range of criteria appropriate for isolating airborne, impact, and structure-borne noise associated with residential construction.</li> </ul>

## 7 Fire-Rated and Acoustic Performance Rated Details

### 7.1 Fire Rated Assemblies

Tables 7.1 through 7.3 summarize the fire-rated assemblies that are relevant to residential construction. A comprehensive list of cold-formed steel fire-resistance assemblies is provided in Appendix A. The contents of these tables are compiled from the three main sources of information for fire and acoustic details: UL, Gypsum Association and Factory Mutual. Appendix B contains a list of Canadian fire-rated assemblies [56].

#### 7.1.1 Walls

**Table 7.1 – Fire-Rated Wall Assemblies – Non Load Bearing**

(Not complete construction details; consult original source for detailed information. UL- Underwriters Laboratories, Inc.)

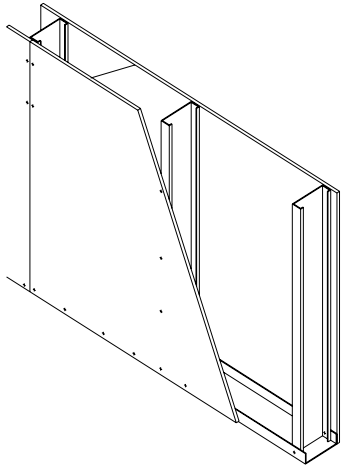
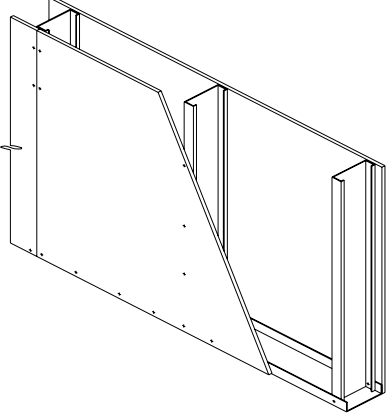
Source	Construction Detail	Specification	Fire-Rating (minutes)
UL U404		<ul style="list-style-type: none"> <li>• Non-Load Bearing Wall</li> <li>• 350S162-33 studs @ 16" o.c.</li> <li>• 5/8" gypsum board on one side</li> <li>• 1/2" cementitious backer board on other side</li> <li>• 3" thick mineral wool batts</li> </ul>	60
UL U407		<ul style="list-style-type: none"> <li>• Non-Load Bearing Wall</li> <li>• 350S162-18 studs @ 16" o.c.</li> <li>• 1/2" cementitious backer board, ceramic tiles and exterior finish system on either side</li> <li>• 3" mineral wool batts</li> </ul>	60
UL U419		<ul style="list-style-type: none"> <li>• Non-Load Bearing Wall</li> <li>• 350S162-18 studs @ 24" o.c.</li> <li>• 5/8" gypsum board on each side of wall</li> </ul>	60

**Table 7.1 – Fire-Rated Wall Assemblies – Non Load Bearing (cont.)**

(Not complete construction details; consult original source for detailed information. UL- Underwriters Laboratories, Inc.)

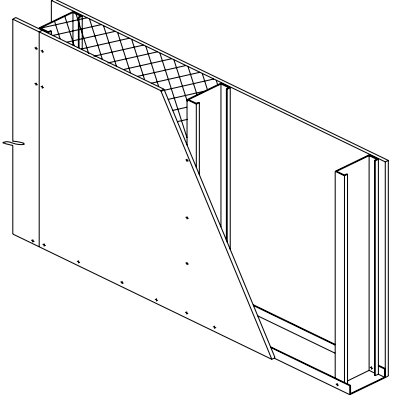
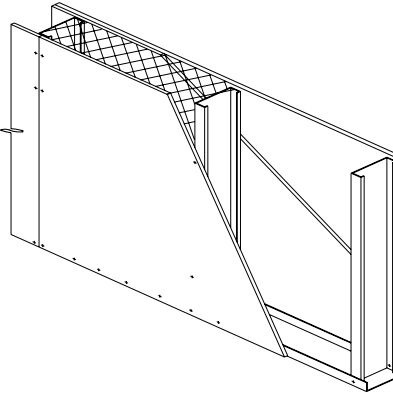
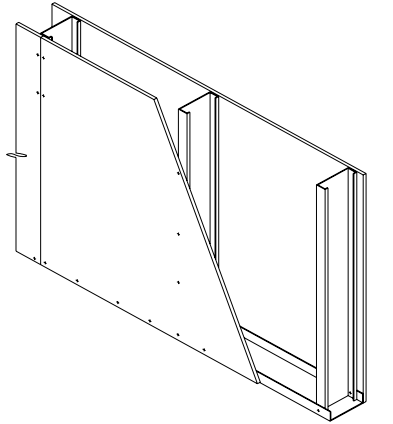
Source	Construction Detail	Specification	Fire-Rating (minutes)
UL U456		<ul style="list-style-type: none"> <li>• Non-Load Bearing Wall</li> <li>• 362S137-33 studs @ 16" o.c.</li> <li>• 5/8" gypsum board on one side</li> <li>• 3/8" mineral and fiber board on other side</li> <li>• Mineral wool, 3 pcf density</li> </ul>	60
UL U457		<ul style="list-style-type: none"> <li>• Non-Load Bearing Wall</li> <li>• 362S125-18 studs @ 16" o.c.</li> <li>• 5/8" gypsum board on one side</li> <li>• 1/2" XPS and 1/2" cementitious backer board on other side</li> <li>• 3" batt or blanket insulation between stud cavity</li> </ul>	60
UL U465 UL U495		<ul style="list-style-type: none"> <li>• Non-Load Bearing Wall</li> <li>• 362S125-18 studs @ 24" o.c.</li> <li>• 5/8" gypsum board on each side of wall</li> </ul>	60

**Table 7.1 – Fire-Rated Wall Assemblies – Non Load Bearing (cont.)**

(Not complete construction details; consult original source for detailed information. UL- Underwriters Laboratories, Inc.)

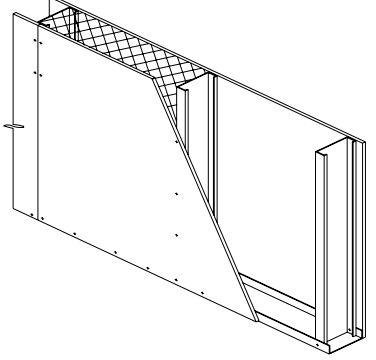
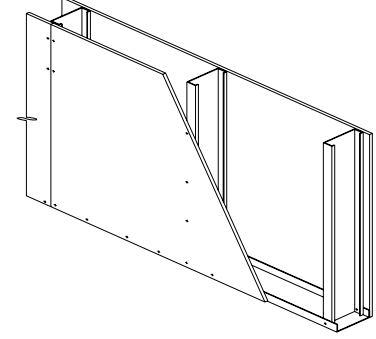
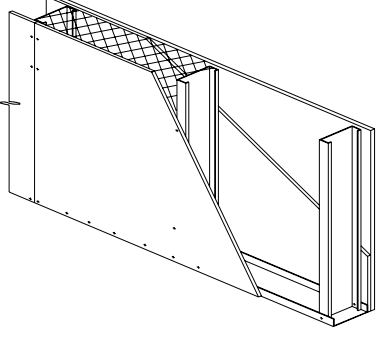
Source	Construction Detail	Specification	Fire-Rating (minutes)
UL V413		<ul style="list-style-type: none"> <li>• Non-Load Bearing Wall</li> <li>• 362S125-33 studs @ 24" o.c.</li> <li>• 5/8" gypsum board on one side of wall</li> <li>• No. 15 asphalt felt building paper, 5/8" gypsum board, 4.5 oz/sq yd fiberglass mesh, 3/32" base coat, 1/16" thick finish coat on other side</li> <li>• Mineral wool batts for exterior walls</li> </ul>	60
UL V416		<ul style="list-style-type: none"> <li>• Non-Load Bearing Wall</li> <li>• 362S125-33 studs @ 24" o.c.</li> <li>• 5/8" faced gypsum board on each side (or 3/4" faced gypsum board on each side)</li> </ul>	60
UL U449		<ul style="list-style-type: none"> <li>• Non-Load Bearing Wall</li> <li>• 362S125-18 studs @ 24" o.c.</li> <li>• 7/16" mineral fiber and 1/4" ceramic tiles on one side</li> <li>• (2) 5/8" gypsum board on other side</li> <li>• Batt or blanket insulation in stud cavity (min. density 3.5 pcf)</li> </ul>	90

**Table 7.1 – Fire-Rated Wall Assemblies – Non Load Bearing (cont.)**

(Not complete construction details; consult original source for detailed information. UL- Underwriters Laboratories, Inc., GA – Gypsum Association)

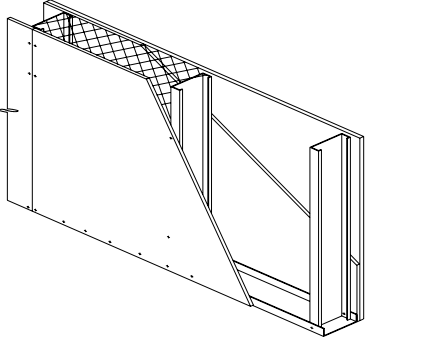
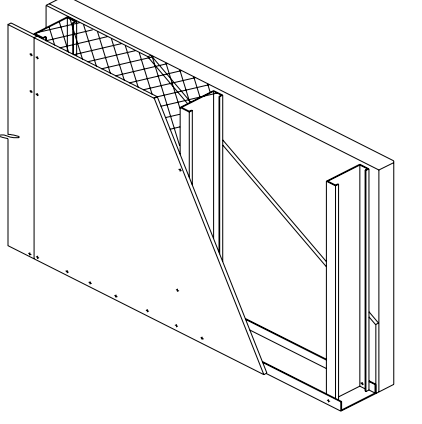
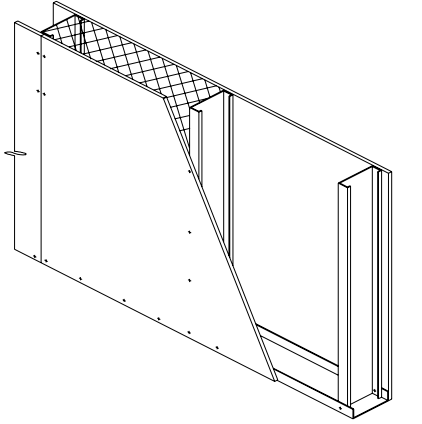
Source	Construction Detail	Specification	Fire-Rating (minutes)
UL U452		<ul style="list-style-type: none"> <li>• Non-Load Bearing Wall</li> <li>• 350S125-33 studs @ 24" o.c.</li> <li>• 18 mil resilient channel with 1/2" gypsum board on one side</li> <li>• (2) 1/2" gypsum board on other side</li> <li>• 3" Batt or blanket insulation in stud cavity</li> </ul>	90
UL V414		<ul style="list-style-type: none"> <li>• Non-Load Bearing Wall</li> <li>• 362S162-33 studs @ 16" o.c.</li> <li>• 5/8" gypsum board on one side of wall</li> <li>• 2" foam plastic board, metal brackets for ties, 4" wide brick veneers w/2" air space between veneer and foam</li> <li>• 3-1/2" fiber glass batts (0.8 pcf density)</li> </ul>	180
GA WP 1035		<ul style="list-style-type: none"> <li>• Non-Load Bearing Wall</li> <li>• 362S162-33 studs @ 24" o.c.</li> <li>• 5/8" Type X gypsum board on one side of wall</li> <li>• 1/2" cementitious board on other side</li> <li>• 3" mineral fiber insulation in cavity</li> </ul>	60

**Table 7.1 – Fire-Rated Wall Assemblies – Non Load Bearing (cont.)**

(Not complete construction details; consult original source for detailed information. GA – Gypsum Association)

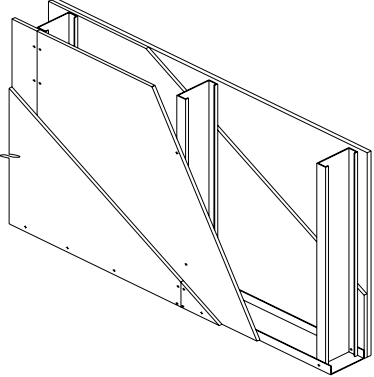
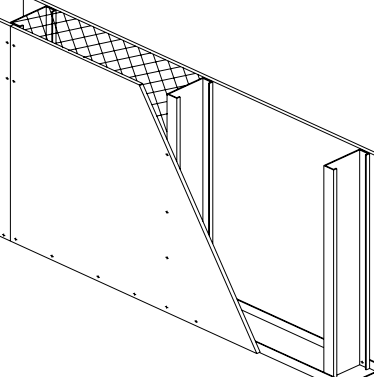
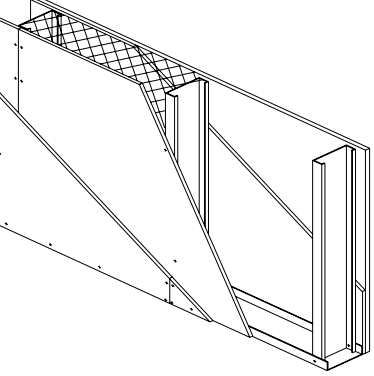
Source	Construction Detail	Specification	Fire-Rating (minutes)
GA WP 1041		<ul style="list-style-type: none"> <li>• Non-Load Bearing Wall</li> <li>• 362S162-33 studs @ 24" o.c.</li> <li>• 1/2" Type X gypsum board and 1/2" fiber cement board on one side of wall</li> <li>• 1/2" Type X gypsum board and 1/2" fiber cement board on other side of wall</li> </ul>	60
GA WP 1082		<ul style="list-style-type: none"> <li>• Non-Load Bearing Wall</li> <li>• 362S162-18 studs @ 16" o.c.</li> <li>• 5/8" Type X gypsum board on each side of wall</li> <li>• 3" mineral fiber insulation in cavity</li> </ul>	60
GA WP 1470		<ul style="list-style-type: none"> <li>• Non-Load Bearing Wall</li> <li>• 362S162-18 studs @ 16" o.c.</li> <li>• (2) 1/2" Type X gypsum board on one side of wall</li> <li>• Furring channels and (2) 1/2" Type X gypsum on other side of wall</li> <li>• 3" mineral fiber insulation in cavity</li> </ul>	120

**Table 7.1 – Fire-Rated Wall Assemblies – Non Load Bearing (cont.)**

(Not complete construction details; consult original source for detailed information. GA – Gypsum Association)

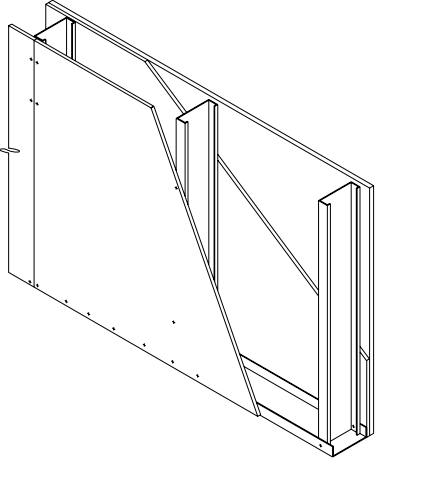
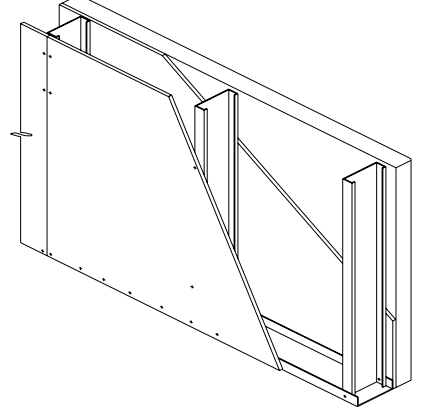
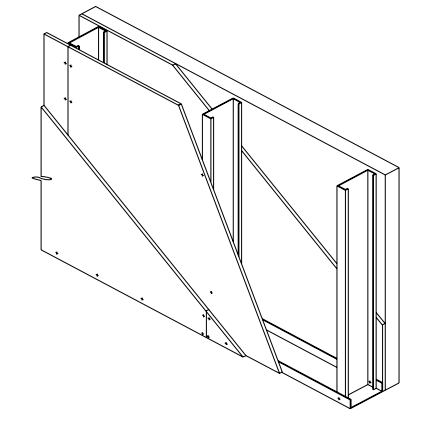
Source	Construction Detail	Specification	Fire-Rating (minutes)
GA WP 8003		<ul style="list-style-type: none"> <li>• Non-Load Bearing Wall</li> <li>• 362S162-33 studs @ 24" o.c.</li> <li>• 5/8" Type X gypsum board on one side of wall</li> <li>• 1/2" Type X gypsum board and 1/4" fiber cement board on other side of wall</li> </ul>	60
GA WP 8122		<ul style="list-style-type: none"> <li>• Non-Load Bearing Wall</li> <li>• 362S162-43 studs @ 16" o.c.</li> <li>• 5/8" Type X gypsum board on one side of wall</li> <li>• 5/8" Type X gypsum board and EIFS with 2" XPS on other side</li> </ul>	60
GA WP 8123		<ul style="list-style-type: none"> <li>• Non-Load Bearing Wall</li> <li>• 362S162-43 studs @ 24" o.c.</li> <li>• 5/8" Type X gypsum board on one side of wall</li> <li>• 5/8" Type X gypsum board and EIFS with 4" XPS on other side</li> </ul>	60
GA WP 8202		<ul style="list-style-type: none"> <li>• Non-Load Bearing Wall</li> <li>• 362S162-43 studs @ 24" o.c.</li> <li>• (2) 5/8" Type X gypsum board on one side of wall</li> <li>• (2) 5/8" Type X gypsum board and EIFS with 4" XPS on other side</li> </ul>	120



**Table 7.1 – Fire-Rated Wall Assemblies – Non Load Bearing (cont.)**

(Not complete construction details; consult original source for detailed information. GA – Gypsum Association)

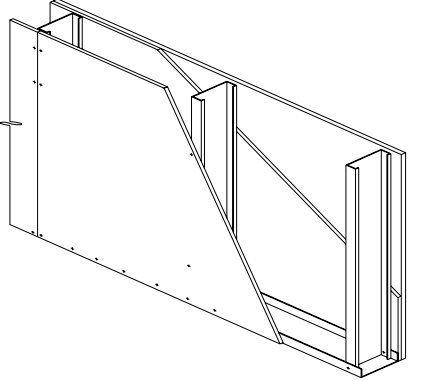
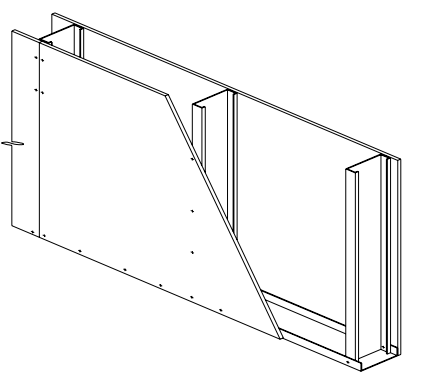
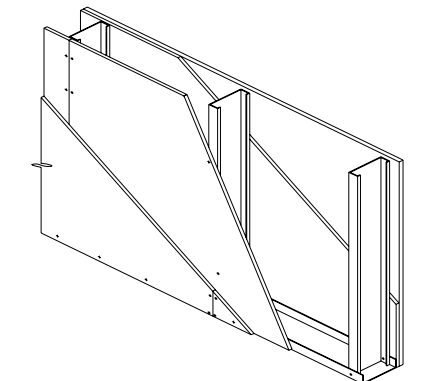
Source	Construction Detail	Specification	Fire-Rating (minutes)
GA WP 8250		<ul style="list-style-type: none"> <li>• Non-Load Bearing Wall</li> <li>• 362S162-33 studs @ 16" o.c.</li> <li>• 5/8" foil-backed gypsum board on one side of wall</li> <li>• 1/2" gypsum with stucco</li> </ul>	120
FM Wall 1		<ul style="list-style-type: none"> <li>• Non-Load Bearing Wall</li> <li>• 362S162-22 studs @ 24" o.c.</li> <li>• 5/8" gypsum board on each side of wall</li> </ul>	60
FM Wall 7		<ul style="list-style-type: none"> <li>• Non-Load Bearing Wall</li> <li>• 362S137-22 studs @ 24" o.c.</li> <li>• (2) 5/8" gypsum board on each side of wall</li> </ul>	120

**Table 7.2 – Fire-Rated Wall Assemblies – Load Bearing**

(Not complete construction details; consult original source for detailed information. UL- Underwriters Laboratories, Inc.)

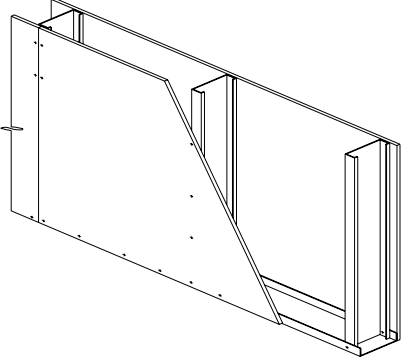
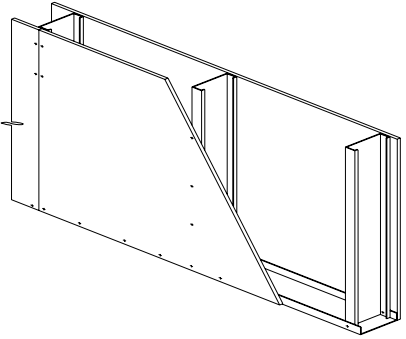
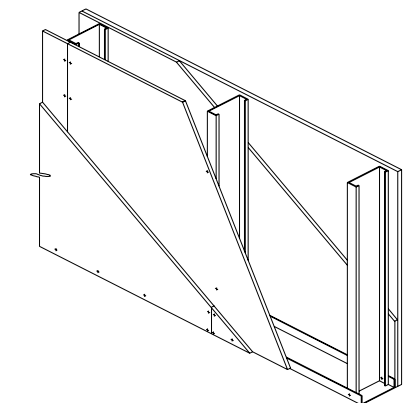
Source	Construction Detail	Specification	Fire-Rating (minutes)
UL U432		<ul style="list-style-type: none"> <li>• Load Bearing Wall</li> <li>• 350S162-33 @ 24" o.c.</li> <li>• 5/8" gypsum wallboard on each side</li> </ul>	60
UL U434		<ul style="list-style-type: none"> <li>• Load Bearing Wall</li> <li>• 350S162-33 @ 24" o.c.</li> <li>• 5/8" gypsum wallboard on one side</li> <li>• 7/8" Portland cement plaster over metal lath on other side</li> </ul>	60
UL U440		<ul style="list-style-type: none"> <li>• Load Bearing Wall</li> <li>• 350S162-33 @ 24" o.c.</li> <li>• (2) 1/2" gypsum wallboard on each side of wall</li> </ul>	60

**Table 7.2 – Fire-Rated Wall Assemblies – Load Bearing**

(Not complete construction details; consult original source for detailed information. UL- Underwriters Laboratories, Inc.)

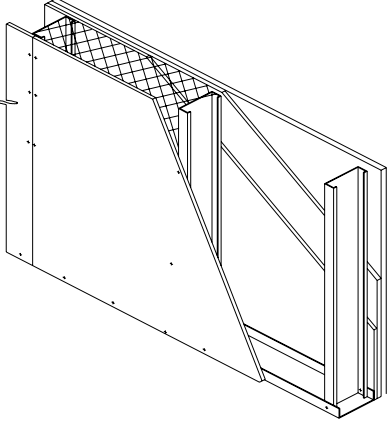
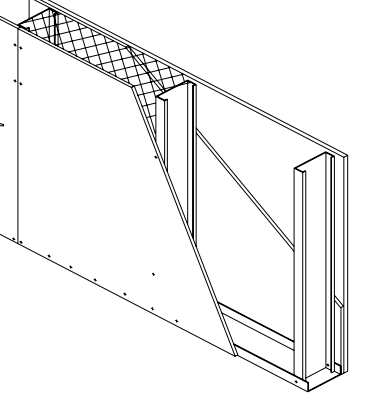
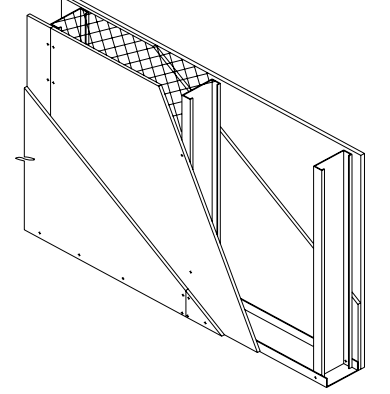
Source	Construction Detail	Specification	Fire-Rating (minutes)
UL U460		<ul style="list-style-type: none"> <li>• Load Bearing Wall</li> <li>• 350S125-33 @ 24" o.c.</li> <li>• 5/8" gypsum wallboard on one side</li> <li>• 5/8" gypsum, 1" rigid polyiso. insulation, 1/2" plywood on other side</li> <li>• 3" batts or blankets</li> </ul>	60
UL U473		<ul style="list-style-type: none"> <li>• Load Bearing Wall</li> <li>• 350S125-33 @ 16" o.c.</li> <li>• 5/8" gypsum wallboard on one side</li> <li>• 1/2" cementitious board and 5/8" gypsum board on other side</li> <li>• 3" batts or blankets</li> </ul>	60
UL U423		<ul style="list-style-type: none"> <li>• Load Bearing Wall</li> <li>• 350S162-33 @ 24" o.c.</li> <li>• (2) 5/8" gypsum wallboard on each side of wall</li> <li>• 2" mineral wool batts</li> </ul>	120

**Table 7.2 – Fire-Rated Wall Assemblies – Load Bearing**

(Not complete construction details; consult original source for detailed information. UL- Underwriters Laboratories, Inc.)

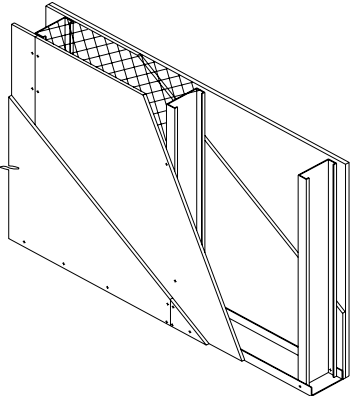
Source	Construction Detail	Specification	Fire-Rating (minutes)
UL U425		<ul style="list-style-type: none"> <li>• Load Bearing Interior Wall</li> <li>• 350S125-33 @ 24" o.c.</li> <li>• 5/8" gypsum wallboard on each side</li> <li>• Batt insulation</li> </ul>	60
		<ul style="list-style-type: none"> <li>• Load Bearing Interior Wall</li> <li>• 350S125-33 @ 24" o.c.</li> <li>• (2) 1/2" gypsum wallboard on each side</li> <li>• Batt insulation</li> </ul>	90
		<ul style="list-style-type: none"> <li>• Load Bearing Interior Wall</li> <li>• 350S125-33 @ 24" o.c.</li> <li>• (3) 1/2" gypsum wallboard on each side or (2) layers of 5/8" gypsum wall board on each side.</li> <li>• Batt insulation</li> </ul>	120
		<ul style="list-style-type: none"> <li>• Load Bearing Exterior Wall</li> <li>• 350S125-33 @ 24" o.c.</li> <li>• 1/2" gypsum wall board with Brick/Stucco, 1/2" or 5/8" cementitious backer unit, or mineral fiber board</li> <li>• (2)-1/2" gypsum wallboard on fire side</li> <li>• Batt insulation</li> </ul>	60
		<ul style="list-style-type: none"> <li>• Load Bearing Exterior Wall</li> <li>• 350S125-33 @ 24" o.c.</li> <li>• 1/2" gypsum wall board with Brick/Stucco, 1/2" or 5/8" cementitious backer unit, or mineral fiber board</li> <li>• (2)-5/8" gypsum wallboard on fire side</li> <li>• Batt insulation</li> </ul>	90
		<ul style="list-style-type: none"> <li>• Load Bearing Exterior Wall</li> <li>• 350S125-33 @ 24" o.c.</li> <li>• 1/2" gypsum wall board with Brick/Stucco, 1/2" or 5/8" cementitious backer unit, or mineral fiber board</li> <li>• (3)-1/2" gypsum wallboard on fire side</li> <li>• Batt insulation</li> </ul>	120

**Table 7.2 – Fire-Rated Wall Assemblies – Load Bearing (cont.)**

(Not complete construction details; consult original source for detailed information. GA – Gypsum Association)

Source	Construction Detail	Specification	Fire-Rating (minutes)
GA WP 1035		<ul style="list-style-type: none"> <li>• Load Bearing Wall</li> <li>• 350S162-33 @ 16" o.c.</li> <li>• 1/2" cementitious board</li> <li>• 5/8" Type X gypsum wallboard</li> <li>• 4-5/8" batt insulation</li> </ul>	60
GA WP 1026		<ul style="list-style-type: none"> <li>• Load Bearing Wall</li> <li>• 350S162-33 @ 16" o.c.</li> <li>• 5/8" Type X gypsum wallboard on each side of wall</li> </ul>	60
GA WP 1716		<ul style="list-style-type: none"> <li>• Load Bearing Wall</li> <li>• 350S162-33 @ 24" o.c.</li> <li>• (2) 1/2" Type X gypsum wallboard on each side of wall</li> </ul>	120

7.1.2 Floors

**Table 7.3 – Fire-Rated Floor Assemblies**  
 (Not complete construction details; consult original source for detailed information.)  
 (UL- Underwriters Laboratories, Inc., GA – Gypsum Association)

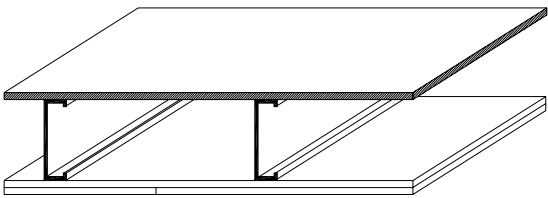
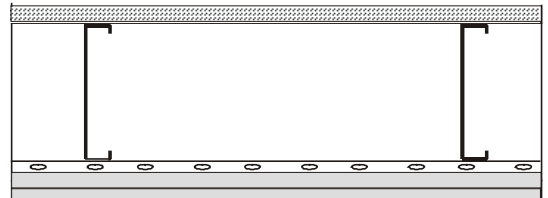
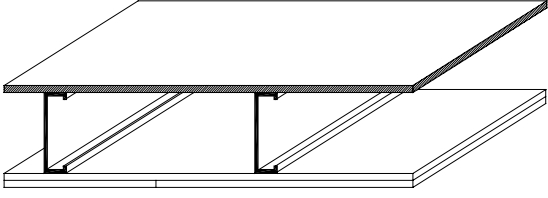
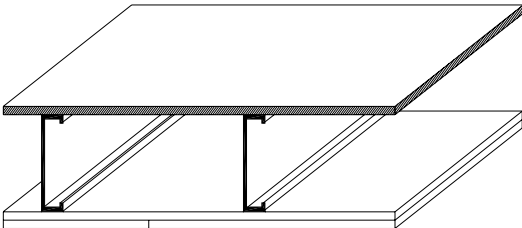
Source	Construction Detail	Description	Fire-Rating (minutes)
UL L524		<ul style="list-style-type: none"> <li>• 700S162-43 @ 24" o.c.</li> <li>• 19/32" plywood on top</li> <li>• (2) 1/2" gypsum board on bottom</li> </ul>	60
UL L527		<ul style="list-style-type: none"> <li>• 938S162-54 @ 24" o.c.</li> <li>• 3/4" plywood on top with furring channels</li> <li>• (2) 1/2" gypsum board on bottom with 24 gauge resilient channels spaced at 16" o.c.</li> </ul>	90
UL L543		<ul style="list-style-type: none"> <li>• 800S156-43 @ 19" o.c.</li> <li>• 23/32" plywood on top</li> <li>• (2) 1/2" gypsum board on bottom connected to 362S125-43 ceiling joists spaced at 16" o.c.</li> </ul>	60
GA FC 4502		<ul style="list-style-type: none"> <li>• 700S162-43 @ 24" o.c.</li> <li>• 1/2" Type X gypsum board (base layer)</li> <li>• 1/2" Type X gypsum board (face layer) on bottom</li> <li>• 5/8" T&amp;G plywood on top</li> </ul>	60
GA FC 4503		<ul style="list-style-type: none"> <li>• 700S162-43 @ 24" o.c.</li> <li>• 1/2" Type X gypsum board (base layer)</li> <li>• 1/2" Type X gypsum board (face layer) on bottom</li> <li>• 3/4" T&amp;G plywood on top</li> </ul>	60

**Table 7.3 – Fire-Rated Floor Assemblies (cont.)**  
 (Not complete construction details; consult original source for detailed information.)  
 (CSCC – Canadian Steel Construction Council, see reference [66])

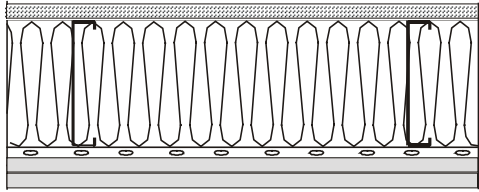
Source	Construction Detail	Specification	Fire-Rating (minutes)
CSCC NRC764- FF22		<ul style="list-style-type: none"> <li>• 800S162-43 @ 16" o.c.</li> <li>• 19/32" plywood on top</li> <li>• Steel strap bridging fastened to underside of joists</li> <li>• Blocking with C-shapes every 5<sup>th</sup> joist</li> <li>• Inverted resilient hat channels spaced at 16" o.c.</li> <li>• (2) ½" Type X gypsum board on bottom</li> </ul>	74
CSCC NRC764- FF23		<ul style="list-style-type: none"> <li>• 800S162-43 @ 16" o.c.</li> <li>• 19/32" plywood on top</li> <li>• Steel strap bridging fastened to underside of joists</li> <li>• Blocking with C-shapes every 5<sup>th</sup> joist</li> <li>• Inverted resilient hat channels spaced at 16" o.c.</li> <li>• 3.5" fiber glass batt insulation between joists</li> <li>• (2) ½" Type X gypsum board on bottom</li> </ul>	68 50/44
CSCC NRC764- FF24		<ul style="list-style-type: none"> <li>• 800S162-43 @ 16" o.c.</li> <li>• 19/32" plywood on top</li> <li>• Steel strap bridging fastened to underside of joists</li> <li>• Blocking with C-shapes every 5<sup>th</sup> joist</li> <li>• Inverted resilient hat channels spaced at 16" o.c.</li> <li>• 3.5" fiber glass batt insulation between joists</li> <li>• (2) ½" Type X gypsum board on bottom</li> </ul>	69

**Table 7.3 – Fire-Rated Floor Assemblies (cont.)**  
 (Not complete construction details; consult original source for detailed information.)  
 (CSCC – Canadian Steel Construction Council, see reference [56])

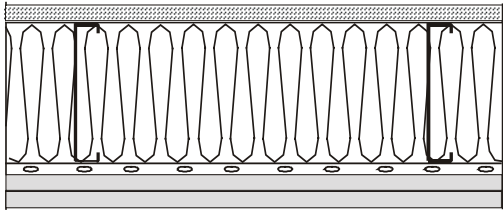
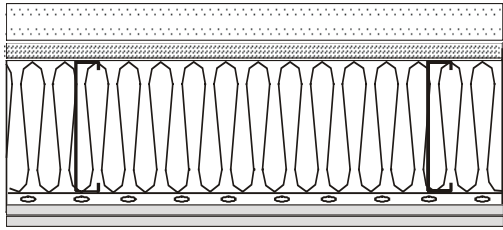
Source	Construction Detail	Specification	Fire-Rating (minutes)
CSCC NRC764- FF25		<ul style="list-style-type: none"> <li>• 800S162-43 @ 16" o.c.</li> <li>• 19/32" plywood on top</li> <li>• Steel strap bridging fastened to underside of joists</li> <li>• Blocking with C-shapes every 5<sup>th</sup> joist</li> <li>• Inverted resilient hat channels spaced at 16" o.c.</li> <li>• 1/2" Type X gypsum board on bottom</li> </ul>	46
CSCC NRC764- FF27		<ul style="list-style-type: none"> <li>• 800S162-43 @ 16" o.c.</li> <li>• 1.5" non-structural concrete topping</li> <li>• 19/32" plywood on top</li> <li>• Steel strap bridging fastened to underside of joists</li> <li>• Blocking with C-shapes every 5<sup>th</sup> joist</li> <li>• Inverted resilient hat channels spaced at 16" o.c.</li> <li>• (2) 1/2" Type X gypsum board on bottom</li> </ul>	60

## 7.2 STC and IIC Rated Assemblies

Tables 7.4 through 7.6 summarize the STS and IIC-rated assemblies that are relevant to residential construction. A comprehensive list of cold-formed steel sound-rated assemblies is provided in Appendix A. The contents of these tables are compiled mainly from the three main sources of information for fire and acoustic details: UL, Gypsum and Factory Mutual. Appendix B contains a list of Canadian STC/IIC ratings [56] for steel assemblies.



## 7.2.1 Walls

**Table 7.4 – Non-Load Bearing Walls – STC Rating**

(Not complete construction details; consult original source for detailed information.)

Source	Stud Designation	Stud Spacing (in.)	Cavity Insulation	Interior Cover	Exterior Cover	STC Rating (dB)
WP1023	362S162	24	2-3/4" glass fiber	(2) 1/2" Type X gypsum	1/2" Type X gypsum	50-54
WP1041	362S162-33	24	None	1/2" Type X gypsum, 1/2" fiber cement board	1/2" Type X gypsum, 1/2" fiber cement board	50-54
WP1052	362S	24	3-1/2" glass fiber	(2) 5/8" Type X gypsum	(2) 5/8" Type X gypsum	50-54
WP1072	362S	24	3-1/2" glass fiber	5/8" Type X gypsum	5/8" Type X gypsum	45-49
WP1081	362S	24	3" mineral fiber	5/8" Type X gypsum	5/8" Type X gypsum	45-49
WP1082	362S162-18	16	3" mineral fiber	5/8" Type X gypsum	5/8" Type X gypsum	45-49
WP1121	362S162-33	24	None	1/2" Type X gypsum, 1/8" fiber cement veneer	1/2" Type X gypsum, 1/8" fiber cement veneer	45-49
WP1200	362S162-18	24	None	5/8" Type X gypsum	5/8" Type X gypsum	40-44
WP1295	362S162-33	24	None	5/8" Type X gypsum	1/2" Type X gypsum, 1/4" fiber cement board	40-44
WP1296	362S	16	3-1/2" mineral fiber	5/8" Type X gypsum	7/16" fiber cement board	40-44
WP1470	350S162-33	24	3" mineral fiber	(2) 1/2" Type X gypsum	Furring, (2) 1/2" Type X gypsum	55-59
WP1510	362S	24	2" glass fiber	(2) 5/8" Type X gypsum	5/8" & 1/2" Type X gypsum, 1/4" or 3/8" gypsum	55-59
WP1515	362S162-33	24	3" mineral fiber	1/2" cementitious, 1/4" ceramic tile	(2) 1/2" type X gypsum	55-59
WP1520	350S162-33	24	3" mineral fiber	1/2" Type X gypsum	Furring, (2) 1/2" Type X gypsum	55-59
WP1521	362S	24	3-1/2" glass fiber	(2) 1/2" Type X gypsum	(2) 1/2" Type X gypsum	55-59
WP1522	362S	24	3-1/2" glass fiber	(2) 5/8" Type X gypsum	(2) 5/8" Type X gypsum	55-59
WP1565	362S162-18	16	3" mineral fiber	(2) 1/2" Type X gypsum	1/2" Type X gypsum, 1/2" cementitious backer	50-54
WP1570	350S	16	3" mineral fiber (2 pcf)	3/4" Type X gypsum	3/4" Type X gypsum	50-54
WP1615	250S	24	None	(2) 1/2" Type X gypsum	(2) 1/2" Type X gypsum	45-49
WP1625	250S125-33	16	2" mineral fiber (3.4 pcf)	3/8" gypsum lath, 3/4" gypsum sand plaster	3/8" gypsum lath, 3/4" gypsum sand plaster	45-49
WP1711	362S	24	None	(2) 5/8" Type X gypsum	(2) 5/8" Type X gypsum	40-44

**Table 7.5 – Load Bearing Walls – STC Rating**  
 (Not complete construction details; consult original source for detailed information.)

Source	Stud Designation	Stud Spacing (in.)	Cavity Insulation	Interior Cover	Exterior Cover	STC Rating (dB)
WP1204	350S162-33	24	None	(2) ½" Type X gypsum	(2) 5/8" Type X gypsum	40-44
WP1206	350S162-33	24	None	5/8" Type X gypsum	5/8" Type X gypsum	40-44
WP1635	350S162-33	24	None	(3) ½" Type X gypsum	(3) ½" Type X gypsum	45-49
WP1714	250S125-43	16	None	(2) 5/8" Type X gypsum	(2) 5/8" Type X gypsum	40-44
WP1716	350S162-33	24	None	(2) ½" Type X gypsum	(2) ½" Type X gypsum	40-44
WP8002	362S162-33	24	3" mineral fiber batts	5/8" gypsum	5/8" gypsum, ½" cementitious board	-
WP1711	362S162-18	24	Full cavity Cocoon insulation	(2) 5/8" Type X gypsum	(2) 5/8" Type X gypsum	58
WP1200	362S162-18	24	1-1/2" Cocoon insulation	5/8" Type X gypsum	5/8" Type X gypsum	50
U419	600S162-18	16	Full cavity Cocoon insulation	(3) 5/8" Type C gypsum	(3) 5/8" Type C gypsum	65
Johns Manville	362S	16	2" fiberglass (0.75 pcf)	½" gypsum board	½" gypsum board	46
Johns Manville	362S	16	2" rockwool (2.0 pcf)	½" gypsum board	½" gypsum board	45

7.2.2 Floors

**Table 7.6 – STC/IIC Rated Floor Assemblies**  
 (Not complete construction details; consult original source for detailed information.)  
 (For NAIMA see reference [53]; for CSCC see reference [56])

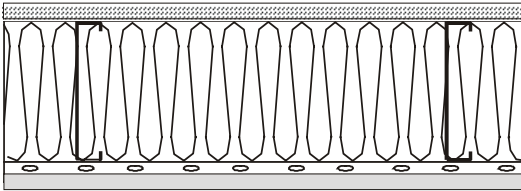
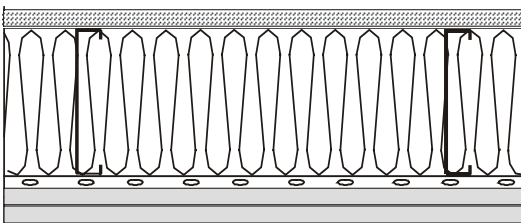
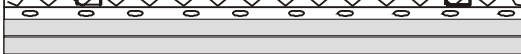
Source	Construction Detail	Specifications	Rating (d)
NAIMA Figure 27		<ul style="list-style-type: none"> <li>• 725S162-43 @ 24" o.c.</li> <li>• T&amp;G plywood subfloor on top</li> <li>• Carpet and pad on top</li> <li>• Steel strap bridging</li> <li>• 3-1/2" glass fiber insulation</li> <li>• Resilient channels</li> <li>• 5/8" gypsum board on bottom</li> </ul>	56/71
CSCC NRC764 -FF22		<ul style="list-style-type: none"> <li>• 800S162-43 @ 16" o.c.</li> <li>• 19/32" plywood on top</li> <li>• Steel strap bridging fastened to underside of joists</li> <li>• Blocking with C-shapes every 5<sup>th</sup> joist</li> <li>• Inverted resilient hat channels spaced at 16" o.c.</li> <li>• (2) 1/2" Type X gypsum board on bottom</li> </ul>	44/40
CSCC NRC764 -FF23		<ul style="list-style-type: none"> <li>• 800S162-43 @ 16" o.c.</li> <li>• 19/32" plywood on top</li> <li>• Steel strap bridging fastened to underside of joists</li> <li>• Blocking with C-shapes every 5<sup>th</sup> joist</li> <li>• Inverted resilient hat channels spaced at 16" o.c.</li> <li>• 3.5" fiber glass batt insulation between joists</li> <li>• (2) 1/2" Type X gypsum board on bottom</li> </ul>	50/44

**Table 7.6 – STC/IIC Rated Floor Assemblies (cont.)**  
 (Not complete construction details; consult original source for detailed information.)  
 (For CSCC see reference [56])

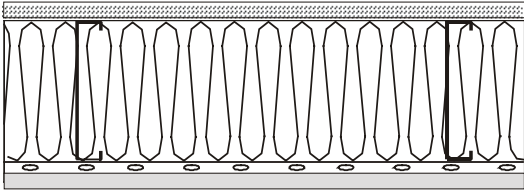
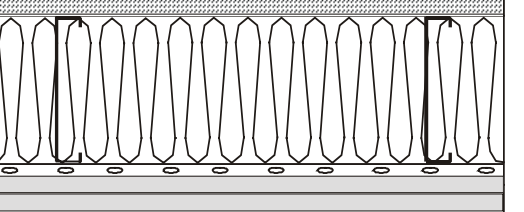
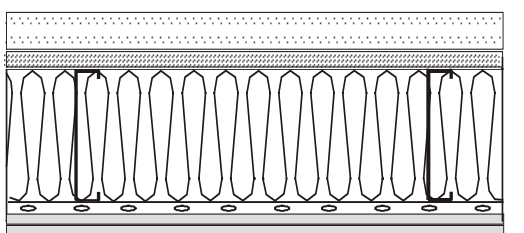
Source	Construction Detail	Specifications	STC/IIC Rating (dB)
CSCC NRC764 -FF24		<ul style="list-style-type: none"> <li>• 800S162-43 @ 16" o.c.</li> <li>• 19/32" plywood on top</li> <li>• Steel strap bridging fastened to underside of joists</li> <li>• Blocking with C-shapes every 5<sup>th</sup> joist</li> <li>• Inverted resilient hat channels spaced at 16" o.c.</li> <li>• 3.5" fiber glass batt insulation between joists</li> <li>• (2) 1/2" Type X gypsum board on bottom</li> </ul>	52/42
CSCC NRC764 -FF25		<ul style="list-style-type: none"> <li>• 800S162-43 @ 16" o.c.</li> <li>• 19/32" plywood on top</li> <li>• Steel strap bridging fastened to underside of joists</li> <li>• Blocking with C-shapes every 5<sup>th</sup> joist</li> <li>• Inverted resilient hat channels spaced at 16" o.c.</li> <li>• 1/2" Type X gypsum board on bottom</li> </ul>	51/44
CSCC NRC764 -FF27		<ul style="list-style-type: none"> <li>• 800S162-43 @ 16" o.c.</li> <li>• 1.5" non-structural concrete topping</li> <li>• 19/32" plywood on top</li> <li>• Steel strap bridging fastened to underside of joists</li> <li>• Blocking with C-shapes every 5<sup>th</sup> joist</li> <li>• Inverted resilient hat channels spaced at 16" o.c.</li> <li>• (2) 1/2" Type X gypsum board on bottom</li> </ul>	60/31

## 8 Summary of Research on Fire Rating and Acoustic Performance of Cold-Formed Steel Framing

### 8.1 Introduction

It is very difficult to summarize all the research and testing that is going in the US. Private laboratories working for private industry usually conduct most, if not all, of the current research on acoustical (sound) performance and fire rating of cold-formed steel assemblies. The list of research is by no means all-inclusive as proprietary research and testing is typically not publicly available.

### 8.2 Fire Rating Research Summary

**Cooper, L. Y., Reneke, P. A.**, “*Prototype Model for Simulating Barrier Fire Performance: CFAST GYPST – For Evaluating Thermal Response of Gypsum-Panel/Steel-Stud Wall System*,” National Technical Information Service (NTIS). U.S. Department of Commerce, Springfield VA.

**Cooper, L. Y., Franssen, J. M.** “*Basis for Using Fire Modeling With 1-D Thermal Analyses of Barriers/Partitions to Simulate 2-D and 3-D Barrier/Partition Structural Performance in Real Fires*.” Fire Safety Journal, Vol. 33, No. 2, 115-128, September 1999.

*Abstract:*

Computer fire models for simulating compartment fire environments typically require a mathematical formulation that couples the thermal response of the gases that fill the compartment and the thermal response of compartment barriers and partitions. The fire environment characteristics calculated by such models can be used to provide input, via thermal boundary conditions, to an uncoupled thermal-structural computer model for simulating and evaluating the combined thermal/structural performance of the barriers/partitions. The objective of such a combined analysis would be to determine, through analysis, the structural fire-resistance of a barrier/partition design.

**Elhadj, Nader**, “*Fire Rated Assemblies of Cold-Formed Steel Construction*,” Light-gauge Steel Engineers Association (LGSEA) Technical Note No. 420. Washington DC. 1998.

**Gilvary, K. R., Dexter, R. J.**, “*Evaluation of Alternative Methods for Fire Rating Structural Elements*.” National Institute of Standards and Technology (NIST) GCR 97-718; ATLSS Report No. 97-05; pp102. Gaithersburg, MD. June 1997.

*Abstract:*

A range of computational methods was evaluated for predicting the load capacity of structures subjected to fire. Results were compared to furnace experiments on loaded steel columns and concrete filled tubes. Simple calculations are accurate for simple cases such as steel columns at uniform temperature. Special-purpose finite-element software, SAFIR, was also accurate for members with nonuniform temperature distributions and/or composite cross-sections. SAFIR

simulations of a continuous frame showed that it withstood three times the fire-exposure duration predicted from column furnace testing. Computational methods could serve as an alternative to the furnace test method for determining fire-resistance ratings.

**Ingberg, S. H., Mitchell, N. D.,** “*Fire Tests of Wood- and Metal-Framed Partitions,*” National Institute of Standards and Technology (NIST). BMS 071; 53 p. May 12, 1941.

*Abstract:*

This report describes in some detail the test partitions and gives the results of 147 fire-endurance or fire and hose-stream tests conducted at the National Bureau of Standards. Seventy-eight of the partitions were of wood or framed with wood studs and faced with wood, wood fiber, or gypsum boards, or with plasters applied on wood, gypsum, expanded-metal, or wire laths. The others were of hollow or solid incombustible nonbearing types, most of which were framed with steel channels and had body or facings of gypsum or Portland cement plaster on metal laths. Most of the wood-study partitions were of the load-bearing type, and 38 of them were tested under a constant working load while exposed to fire. Their fire-resistance limits, depending on the facings, ranged from 10 min with 1/2-inch wood-fiber insulating boards applied on each side to 2 hr with 1-inch-thick facings of neat wood-fibered gypsum plaster. Filling the spaces between studs with mineral wool increased the fire-resistance appreciably. The fire-resistance limit was considered reached when (a) failure under load or passage of flame occurred, (b) the limiting temperature rise (250°F average or 325°F maximum) was reached on the unexposed side, or (c) cotton waste in contact therewith became ignited. The protection given the wood studs by the fire-exposed facing, as based on the limiting temperature rise on the edges facing the furnace, ranged from one-sixth to one-third of the fire-resistance limit of the partition construction as such. The results with metal-framed hollow partitions differed little from those with wood-stud partitions having the same facings, insofar as the rise of temperature on the unexposed surface was concerned, but the former remained longer as barriers to the spread of fire after such technical end points had been reached. For the solid plaster partitions, 2 to 2 1/2 inch thick, the range in fire-resistance was from 20 min with Portland cement sanded plaster or mortar to 2 1/2 hr with un-sanded fibered gypsum plaster. Sanded gypsum plasters gave intermediate results.

**Klippstein, K H.,** “*Preliminary Study on the Column-Strength of Cold-Formed Steel Studs Exposed to Elevated Temperatures.*” American Iron and Steel Institute. Washington DC. 1978.

**Klippstein, K H.,** “*Behavior of Cold-Formed Steel Studs in Fire Tests.*” American Iron and Steel Institute. Washington DC. 1980.

**Klippstein, K H.,** “*Strength of Cold-Formed Studs Exposed to Fire.*” American Iron and Steel Institute. Washington DC. 1980.

**Kodur, V. K. R., et al,** “*Fire-Resistance Tests on Load bearing Steel Stud Walls,*” Proceedings of Third International Conference on Fire Research and Engineering, Society of Fire Protection Engineers, Bethesda, MD, 1999.

**Milke, J.,** “*Analytical Method for Determining Fire Resistance of Steel members.*” The SFPE Handbook of Fire Protection Engineering, pages 3/88-3/112. Society of Fire Protection Engineers. Quincy, MA. 1988.

**NBS**, “*Fire-Resistance and Sound-Insulation Ratings for Walls, Partitions, and Floors.*” US Department of Commerce. National Bureau of Standards. Technical Report on Building Materials TRBM 44. Washington DC. 1944.

*Abstract:*

In the construction of buildings, particularly those of the residential type, partition, and floor constructions should provide safety to life from the spread of fire and should reduce transmitted sounds and objectionable noises to inaudible levels. This paper gives the fire-resistance and sound-insulation ratings of walls, partitions, and floors. Most of the fire-resistance ratings are based on tests made at the National Bureau of Standards. Some are based on tests made at Underwriters' Laboratories or at Ohio State University. All of the sound-insulation ratings are based on tests made at the National Bureau of Standards. The detailed results of many of the fire tests of wood- and metal-framed partitions have been published in Building Materials and Structures Report BMS 71, "Fire Tests of Wood- and Metal-Framed Partitions." The details of the sound-insulation tests are given in Building Materials and Structures Report BMS 44, "Sound Insulation of Wall and Floor Construction", and Supplement. Since the present objective is to present information of value in selecting or designing constructions suitable for use as subdivisions between family units in multiple dwellings, those having fire-resistance ratings of less than 1/2 hr are not included. The ratings are applicable to walls and floors in other types of buildings.

**NBS**, “*Fire-Resistance Classifications of Building Constructions.*” Report of Subcommittee on Fire-Resistance Classifications of the Central Housing Committee on Research, Design and Construction. Building Materials and Structures Report BMS92. National Bureau of Standards. Washington DC. 1942. (Available from the National Technical Information Services, Order Number COM-73-10974).

*Abstract:*

A classification of building construction from the standpoint of fire safety is presented by a committee of representatives of Federal agencies concerned with the design, construction, and operation of buildings. By considering only the basic properties having a bearing on fire hazard and fire-resistance, four types were found sufficient to cover the whole range of building construction. Within each type are two or more classes, which are defined by the fire-resistance required for their structural members. In Chapter 1 this classification is outlined and information given on how it can be applied with reference to the fire severity obtaining for given structural and occupancy conditions. Chapter 2 contains a discussion of the types of restrictions and limitations generally incorporated in building codes, with particular reference to their application to the classification of building types herein presented. Chapter 3 gives results of surveys of combustible contents of buildings housing typical occupancies as a basis for estimation of fire severity. In Chapter 4 are given available fire-resistance ratings of building constructions and fire-resistance classifications of roofing materials.

## 8.2 Acoustical Performance Research Summary

*“Catalog of STC and IIC Ratings for Wall and Floor/Ceiling Assemblies.”* California Department of Health Services. Local Environmental Health Services Branch. Sacramento, California.

**Elhajj, Nader**, *“Acoustic Insulation and Sound Transmission in Cold-Formed Steel Construction”*, Light Gauge Steel Engineers Association (LGSEA) Technical Note No. 360. Washington DC. 1999.

**Loney, W.**, *“Effect of Cavity Absorption and Multiple Layers of Wallboard on the Sound Transmission Loss of Steel-Stud Gypsum Wallboard Partitions.”* The Journal of the Acoustical Society of America: Volume 53, No. 6, 1973.

**Meyers, M., de Souza, K.**, *“Residential Steel Framing, Building a Better North American Home.”* Galvatech 1998. Tokyo, Japan.

**NBS**, *“Sound Insulation of Wall and Floor Construction”*. Department of Commerce. National Bureau of Standards. Building Materials and Structures Report BMS 144. Washington DC.

**Roller, S.**, *“Acoustics in Hotels – Technical Feature.”* Form & Function, Issue 4. Chicago IL. 1988.

**Roller, S., Waropay V.** *“Design Aid for Office Acoustics.”* Form & Function, Issue 4. Chicago IL. 1986.

**Roller, S.**, *“Research Evaluates Role of Density in Acoustical Insulation Performance.”* Form & Function, Issue 2. Chicago IL. 1985.

**Shiner, A.**, *“How to Avoid Flanking Sound in your Acoustical Design.”* Form & Function, Issue 3. Chicago IL. 1993.

**Shiner, A.** *“Sound Control Construction.”* Form & Function, Issue 1. Chicago IL. 1995.



## 9 Fire and Acoustic Research and Testing Needs for Residential Applications

### 9.1 Introduction

The residential cold-formed steel market is still in its infancy in the United States. Although the steel industry, universities, government agencies, research institutions and other associated material and tool manufacturers have done valuable research and testing in the fire and acoustic areas of cold-formed steel, there is still a considerable amount of work that needs to be done.

### 9.2 Research Needs

Fire and acoustic testing of cold-formed steel assemblies in the U.S. is generally done by the private sector with Underwriters Laboratories and Gypsum Association being the leaders. However, limited cold-formed steel assemblies for use in residential applications have been tested by these organizations. The following are some needed testing and research projects:

- AREA SEPARATION WALLS

The objective would be to develop designs, either through engineering analysis or testing, for area separation walls that both can meet the need for one and two hour fire resistance ratings and the necessary acoustic requirements for residential construction. The unique demands of these walls is that they need to be self-supporting and be able to break away from an adjacent residential dwelling(s), as well as having the above noted fire and acoustic characteristics.

Currently low-rise multi-family wood-framed buildings can achieve the 1-hr fire rating and attains an acceptable acoustical rating by constructing a double stud wall with 5/8" (16 mm) gypsum board on each exterior side and a 1-inch (25.4 mm) air gap in the middle. The only UL tested assembly that comes close to the wood assembly requires additional layers of gypsum board between the studs. This is costly and labor intensive.

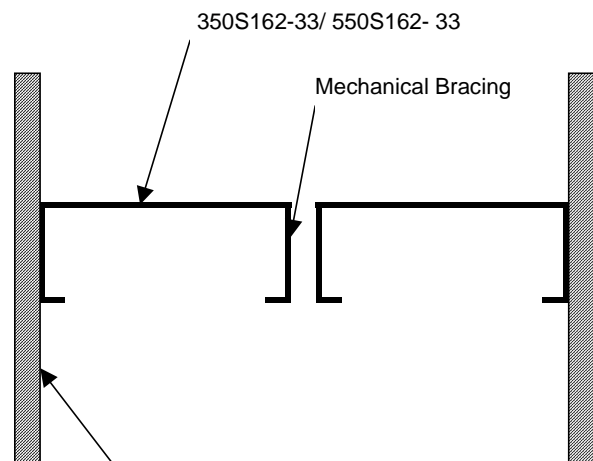

- COMPONENT ADDITIVE METHOD

The objective would be the development of an analytical method (e.g. simplified analytical method) for evaluating a construction assembly using cold-formed steel framing. While the wood industry has had the opportunity of such an approach (e.g. Harmathey's Rule) it was developed using tested assemblies of wood frame construction. As a result, a barrier to the steel industry is the perception that there could not be a substitution of framing members without some form of substantiation as to the validity of that approach. The work would require fire endurance testing, in combination with an analytical analysis of existing fire endurance tests, to compare and validate the Harmathey Rule component additive method to assemblies containing cold-formed steel framing.

- TWO-HOUR FLOOR/CEILING ASSEMBLY

The objective would be the testing and listing of two-hour rated fire resistance floor/ceiling assemblies containing cold-formed steel framing and wood sheathing. At this time only one such test has been completed through a joint venture with the Gypsum Association. The barriers that support the future development in this arena are the lack of available options for cold-formed steel framing to be used in buildings containing mixed occupancies (e.g. where the separation of the occupancies requires two-hour rated construction).

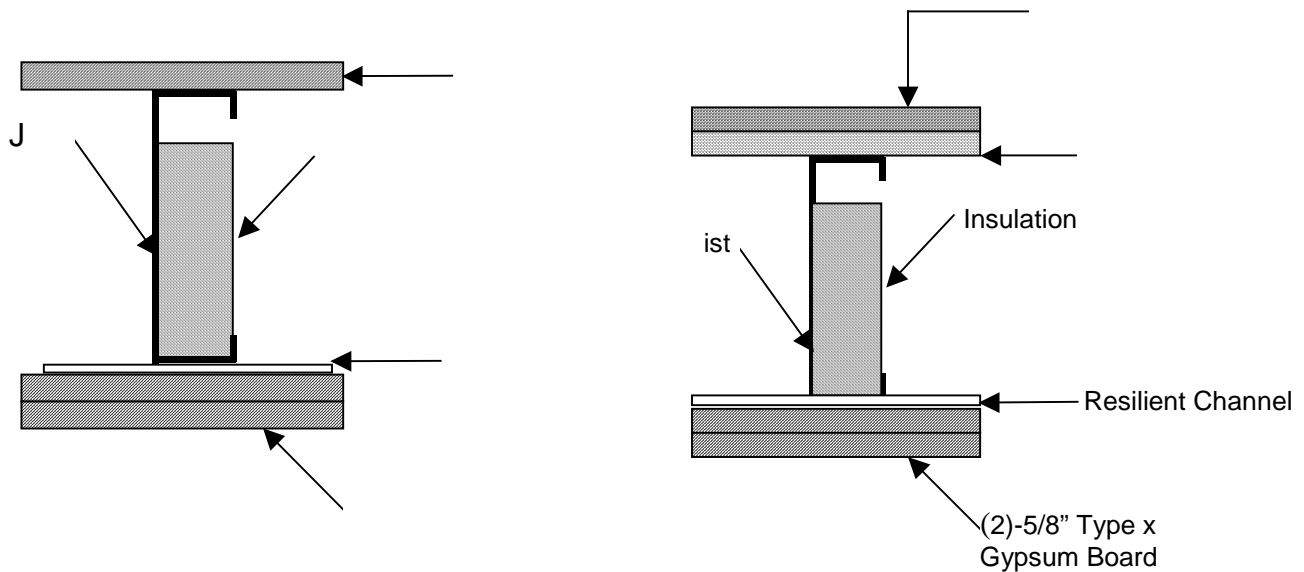

- ACOUSTIC DATA

Very limited data exist in the U.S. on the IIC ratings of steel floors. Although one could find a fire resistance rated design(s), one cannot find a fire resistance rated design that also has acceptable acoustical test data for that exact same assembly. Testing is required to expand the current data.

- TRUSSES

There has been widespread concern among the fire service, manufacturing, fire sprinkler and insurance communities regarding the fire performance of construction that relies more for strength on engineering design than on mass. The concern is for firefighter and occupant safety and roof or floor collapse. The concern is mainly for single-family residences with steel trusses and whether cold-formed steel trusses would be susceptible to sudden and unpredictable collapse when subjected to fire conditions. Guidance is needed on how to deal with light-gauge structures safely and effectively.

- EXTERIOR WALLS

Exterior fire rated walls with stucco finishes are widely used in the southwest region of the U.S. Underwriters Laboratory (UL) fire resistance design number U434 (2001 edition) provides the fire rating for such construction details. However the support system for the stucco in UL design U434 is a paper backed diamond mesh (expanded steel, min. 3/4 lb./sq.yd. attached to the studs). The diamond mesh backing is more labor intensive to install than the 2x2x16ga backing, which is the preferential material.

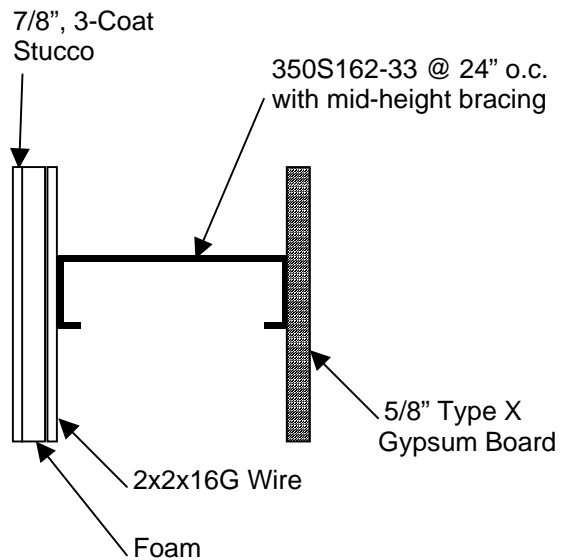

- INTERNATIONAL FIRE AND ACOUSTIC DATA

There is a considerable amount of test data available in other countries on fire and acoustic performance of cold-formed steel assemblies. It is unfortunate that these tests cannot be accepted in the US automatically since in all likelihood the test standard used would not be the ASTM standard. If it were possible to get the different building code bodies to agree on accepting other test standards, it could open up a much wider range of available assemblies.

- STRENGTH OF COLD-FORMED AT ELEVATED TEMPERATURES

Steel loses its strength and becomes elastic under high temperatures. As a matter of fact steel loses approximately 40% of its strength at 932 °F (500°C) and 60% at 1,112 °F (600°C). Although these temperatures are higher than the average temperatures typical steel-framed members are exposed to during the initial time of a fire (due to the presence of drywall and/or other fire-resistance materials), loss of strength is a concern for unfinished basements, improperly finished ceilings or fires starting in attics. These concerns are valid and more people are becoming aware of these facts and issues

- GUIDE TO FIRE RESISTANCE OF STEEL FRAMING

A pamphlet or a builder's guide describing the non-combustibility of steel and highlighting the importance of adequate insulation and caulking to maintain the STC rating. The guide should be written in a language for the average builder and consumer.



## 10 References

- 1 “2001 Steel Framing Alliance Annual Report”. Steel Framing Alliance, Washington DC. September 2001.
- 2 “Prescriptive Method for Residential Cold-Formed Steel Framing,” U.S. Department of Housing and Urban Development (HUD). Washington DC. 1996.
- 3 *One and Two Family Dwelling Code*. Council of American Building Officials (CABO), Falls Church, Virginia. 1997.
- 4 *International Residential Code (IRC)*. International Code Council, Inc. (ICC), Falls Church, Virginia. 2000.
- 5 Sidey, M.P. and Teague, D.P. “Elevated Temperature Data for Structural Grades of Galvanized Steel.” British Steel (Welsh Laboratories) Report, January 1988.
- 6 Klippstein K. H., “Strength of Steel Studs Exposed to Fire,” Proceeding of the Fourth International Specialty Conference on Cold-Formed Steel Structures, Volume II. University of Missouri – Rolla. 1978.
- 7 ASTM E119. “Standard Test Methods for Fire Tests of Building Construction and Materials,” American Society of Testing and Materials, West Conshohocken, PA. 1995.
- 8 Australian Building Code Board, Regulatory Impact Statement. RD 2001/02. May 2001.
- 9 “A Guide to Airborne, Impact, and Structure Borne - Noise Control in Multifamily Dwellings”. U.S. Department of Housing and Urban Development, Washington DC. HUD, 1968.
- 10 Elhajj, Nader. “Acoustic Insulation and Sound Transmission in Cold-Formed Steel Construction.” Light-Gauge Steel Engineers Association (LGSEA) Technical Note No. 360. Washington DC. 1999.
- 11 “Acoustics – Measurement of Sound Insulation in Buildings and of Building Elements – Part 4: Field Measurement of Airborne Sound Insulation Between Rooms” and Part 6: Laboratory Measurements of Impact Sound Insulation of Floors,” International Organization for Standardization. ISO 140-4. 1998.
- 12 Digest 337, “Sound Insulation: Basic Principles”, BRE, 1988.
- 13 Shi, W., Agren, A. “Modeling of Impact Sound Insulation of Lightweight Steel Framing Floors.” Lulea University of Technology Research Report 2000:01, Finland 2000.
- 14 “Dry Construction - the Finish Approach,” VTT Technology, Helsinki, Finland. 1999.
- 15 Sipari, P., “Sound Insulation of Steel Houses”. VTT Building Technology, Proceedings of the 9<sup>th</sup> Nordic Steel Construction Conference, Helsinki, Finland. June 2001.

- 16 Sipari, P., Neinonen, R., & Parmanen, J., “*Acoustic Properties of Wooden Floor Slabs*,” VTT Technical Research Center of Finland, 1998.
- 17 *International One and Two Family Dwelling Code*. International Code Council, Inc. (ICC), Falls Church, Virginia. 1998.
- 18 *Uniform Building Code*. International Conference of Building Officials (ICBO), Whittier, California. 1997.
- 19 *National Building Code*. Building Officials and Code Administrators International, Inc. (BOCA), Country Club Hills, Illinois. 1997.
- 20 *Standard Building Code*. Southern Building Code Congress International, Inc. (SBCCI), Birmingham, Alabama. 1999.
- 21 *International Building Code (IBC)*. International Code Council, Inc. (ICC), Falls Church, Virginia. 2000.
- 22 “*2000 Fire Loss in the U.S.*” National Fire Protection Association. Quincy, MA. 2000.
- 23 “*Firefighter Fatalities in the United States in 2000*” FEMA/United States Fire Administration (USFA). Emmitsburg, MD, 2000.
- 24 “*Fire Tests of Building Construction and Materials*,” UBC Standard 7-1, International Conference of Building Officials, Whittier, California. 1997.
- 25 ASTM E814, “*Standard Test Method for Fire Tests of Through-Penetration Fire Stops*.” American Society of Testing and Materials, West Conshohocken, PA. 2000.
- 26 “*Factory Mutual System, Insulated Wall Constructions, Approved Class Number 4411*”, Factory Mutual. Norwood, MA. 1974.
- 27 “*Factory Mutual System, Class I Insulated Deck Roofs, Approved Class Number 4450*”, Factory Mutual. Norwood, MA. 1989.
- 28 “*Fire-Resistance Tests - Elements of Building Construction*,” International Standard for Standardization ISO 834, 1-16. 1975.
- 29 “*Fire Tests of Through-Penetrations Fire Stops*,” ANSI/UL 1479, Underwriters Laboratories Inc. (UL). Northbrook Illinois. 2001.
- 30 “*Standard Fire Tests of Building Construction and Materials*,” ANSI/UL 263, Underwriters Laboratories Inc. (UL). Northbrook Illinois. 2001.
- 31 “*Tests for Fire Resistance of Building Joint Systems*,” ANSI/UL 2079. Underwriters Laboratories Inc. (UL). Northbrook Illinois. 2001.
- 32 “*Fire Rating and Certification for Products and Systems*,” Intertek Testing Services, ITS BU 606, Cortland NY, 1997.

- 33 ASTM E90, “*Standard Test Method for Laboratory Measurement of Airborne Sound Transmission Loss of Building Partitions and Elements*,” American Society of Testing and Materials, West Conshohocken, PA. 1999.
- 34 ASTM E336, “*Standard Test Method for Measurement of Airborne Sound Insulation in Buildings*,” American Society of Testing and Materials, West Conshohocken, PA. 1997.
- 35 ASTM 413, “*Classification E413-87 (1999) Standard Classification for Rating Sound Insulation*,” American Society of Testing and Materials, West Conshohocken, PA. 1999.
- 36 ASTM E492, “*Standard Test Method for Laboratory Measurement of Impact Sound Transmission Through Floor-Ceiling Assemblies Using the Tapping Machine*” American Society of Testing and Materials, West Conshohocken, PA. 1996.
- 37 “*Fire Resistance Ratings of Load Bearing Steel Studs with Gypsum Wallboard Protection with or without Cavity Insulation*,” Publication FT-901. American Iron and Steel Institute (AISI). Washington DC, 1981.
- 38 “*Fire-Resistance Steel-Frame Construction*,” American Iron and Steel Institute (AISI). Washington DC, 1973.
- 39 “*Designing Fire Protection for Steel Trusses*,” American Iron and Steel Institute. AISI FT 227-1281-20M-NB, Washington DC, 1981.
- 40 “*Calculated Fire-Resistance*,” Technical Notes on Brick Construction (BIA), 16B, Brick Institute of America. Reston, VA. June 1991.
- 41 “*Factory Mutual System, Specification Tested Products Guide*,” Factory Mutual. Norwood, MA. 1993.
- 42 “*Fire-Resistance Design Manual*” 16<sup>th</sup> Edition, Gypsum Association (GA). Washington DC. 2000.
- 43 “*ITS Directory of Listed Products, Vol. I and II*,” Intertek Testing Services (ITS). Cortland, NY. 1997.
- 44 “*Sound Rated Partitions and Floor-Ceiling Construction*,” Los Angeles Department of Building and Safety Document No. P/BC 2001-69. Los Angeles California. February 2002.
- 45 “*One-Hour Floor/Ceiling Fire-Resistance Test*” and “*Two-Hour Floor/Ceiling Fire-Resistance Test*,” MLSFA Technical Bulletins. Chicago, Illinois.
- 46 “*Fire-Resistance Classifications of Building Constructions National Bureau of Standards*,” NBS Report BMS92. National Bureau of Standards. Washington DC. 1942.
- 47 “*Fire-Resistance and Sound Insulation Ratings for Walls, Partitions and Floors*,” NBS Report TRBM44. National Bureau of Standards. Washington DC.

- 48 “*Extruded Polystyrene Insulation Foamular Commercial Steel Stud System*”, UC Industries, Inc., an Owens Corning Company, UCI. Parsippany, New Jersey. 1996.
- 49 “*Fire-Resistance Directory*,” Underwriters Laboratories Inc. (UL). Northbrook Illinois. 2001.
- 50 “*Fire Ratings of Archaic Materials and Assemblies*”. U.S. Department of Housing and Urban Development (HUD), Washington DC. February 2000.
- 51 “*Catalog of STC and IIC Ratings for Wall and Floor/Ceiling Assemblies*”. California Department of Health Services, Local Environmental Health Services Branch. Sacramento, CA.
- 52 “*Sound Shield for Steel- Framed Construction*,” Johns Manville.
- 53 “*Sound Control for Commercial and Residential Buildings*.” North American Insulation Manufacturers Association (NAIMA). Alexandria, VA. December 1997.
- 54 “*Noise Insulation Standard*,” California Code of Regulations, Title 24, Part 2, Chapter 2-35. California
- 55 “*Architectural Graphic Standards*,” Seventh Edition. The American Institute of Architects (AIA), pp 68 and 69.
- 56 Fox, Steven, “*Summary of Fire and Acoustic Building Code Requirements and Solutions for Residential Steel Framing in Canada*,” Prepared for the NAHB Research Center, Inc., Upper Marlboro, MD. Sep. 2001.
- 57 “*Acoustic and Fire Performance of Light Steel Frame Housing*,” The Steel Construction Institute, Document RT888. England. November 2001.
- 58 Schultz, T. and McMahon, N., “*Noise Assessment Guidelines*.” U.S. Department of Housing and Urban Development (HUD), Washington DC. February 1972.
- 59 “*The Noise Guidebook*.” U.S. Department of Housing and Urban Development (HUD), Washington DC. 1991-281-930/54016.



**Appendix A**  
**List of U.S. Fire- and Sound-Rated Steel Assemblies**



Residential Steel Framing – Fire and Acoustic Details

**Table A1 – UL Non-Load Bearing Walls – Fire-Resistance**  
(Not complete construction details; consult original source for more information)

Source	Stud Designation	Stud Spacing (in.)	Cavity Insulation	Interior Cover	Exterior Cover	Fire-Resistance
U404	350S162-33	24	3" thick mineral wool batts	5/8" gypsum board	½" cementitious backer board	1 hr
U405	250S137-18	24	None	5/8" gypsum board	5/8" gypsum board	1 hr
U406	250S131-18	24	2" batt insulation	½" gypsum board	½" gypsum board	1 hr
U407	350S162-18	16	3" mineral wool	½" cementitious backer board, ceramic tiles, and exterior finish system	½" cementitious backer board, ceramic tiles, and exterior finish system	1 hr
U409	162S50-43	24	None	Metal lath & plaster	Metal lath & plaster	1 hr
U419	350S125-18	24	None	(1) 5/8" gypsum	(1) 5/8" gypsum	1 hr
U442	250S137-18	16	2-1/2" batts or blankets	5/8" gypsum board	½" or 5/8" cementitious board, ¼" ceramic tiles	1 hr
U456	362S137-33	16	Mineral wool, 3 pcf	5/8" gypsum board	10 mm mineral and fiber board	1 hr
U457	362S125-18	16	3" batts or blankets	5/8" gypsum board	½" XPS, ½" cementitious board	1 hr
U465	362S125-18	24	(Optional) batts/blankets	5/8" gypsum board	5/8" gypsum board	1 hr
U468	250S100-18	16/24	2-1/2" glass fiber	½" gypsum board	½" gypsum board	1 hr
U488	250S125-33	16	1" mineral wool batts	3/8" gypsum board, 7/16" plaster	3/8" gypsum board, 7/16" plaster	1 hr
U495	362S125-18	24	Optional	5/8" gypsum board	5/8" gypsum board	1 hr
V409	250S137-18	24	1-1/2" mineral wool batts	½" faced gypsum board	½" faced gypsum board	1 hr
V413	362S125-33	24	Mineral wool batts for exterior walls only	5/8" paper or vinyl faced gypsum board	No. 15 asphalt felt building paper, 5/8" gypsum board, 4.5 oz/sq yd fiberglass mesh, 3/32" base coat, 1/16" thick finish coat	1 hr
V416	362S125-18	24	Optional	5/8" faced gypsum board	5/8" faced gypsum board	1 hr
				¾" faced gypsum board	¾" faced gypsum board	
U449	362S137-33	24	Batts and blankets, minimum density 3.5 pcf	7/16" mineral fiber, ¼" ceramic tiles	(2) 5/8" gypsum board	1-1/2 hr
U452	350S125-33	24	3" batts or blankets	(2) ½" gypsum board	18 mil resilient channels, ½" gypsum board	1-1/2 hr
U471	362S125-18	24	3-1/4" mineral wool batts, 4pcf density	5/8" mineral fiber board	5/8" mineral fiber board	1-1/2 hr
U403	362S125-18	24	Mineral wool or glass fiber	2 (5/8") layers 5/8" Gypsum, Inner layer applied w/runner	5/8" gypsum, ½" gypsum, and 3/8" gypsum	2 hr
U411	250S125-18	24	None	(2) 5/8" gypsum	(2) 5/8" gypsum	2 hr
U443	362S125-18	24	3" batts or blankets	½" gypsum board, ½" cementitious board, ¼" ceramic tile	½" gypsum board, ½" cementitious board, ¼" ceramic tile	2 hr

**Table A1 – UL Non-Load Bearing Walls – Fire-Resistance (cont.)**  
 (Not complete construction details; consult original source for more information)

Source	Stud Designation	Stud Spacing (in.)	Cavity Insulation	Interior Cover	Exterior Cover	Fire-Resistance
U453	350S125-33	24	3" batts or blankets	½" gypsum board	18 mil resilient channels, (2) ½" gypsum board,	2 hr
U474	362S125-18	16	3" batts or blankets	(2) ½" gypsum board	½" cementitious board, ½" gypsum board	2 hr
				½" cementitious board, ½" gypsum board	½" cementitious board, ½" gypsum board	
U495	362S125-18	24	Optional	5/8" classified gypsum board	5/8" classified gypsum board	2 hr
U491	350S125-18	24	3" mineral wool batts	¾" gypsum board	¾" gypsum board	2 hr
U493	Double 362S162-43 staggered	16	3-1/2" glass fiber, 0.5 pcf	(2) 5/8" gypsum board, (2) 5/8" gypsum board between studs	(2) 5/8" gypsum board, (2) 5/8" gypsum board between studs	2 hr
V410	162S125-18	24	Optional	½" faced gypsum board, ½" laminated gypsum board	½" faced gypsum board, ½" laminated gypsum board	2 hr
V412	350S125-18	24	3" mineral wool batts	¾" faced gypsum board	¾" faced gypsum board	2 hr
V415	562S162-33	16	3-1/2" mineral wool batts	33 mil furring channels, 2" structural cement fiber board, 5/8" Type X gypsum board	33 mil furring channels, 2" structural cement fiber board, 5/8" Type X gypsum board	2 hr
U408	250S150-18	24	None	1" gypsum board	(3) ¾" gypsum board	3 hr
		24			(4) ¾" gypsum board	4 hr
U419	350S125-18	24	3" glass fiber or mineral wool	(1) ¾" gypsum	(1) ¾" gypsum	2 hr
	162S125-18		None	(3) ½" gypsum	(3) ½" gypsum	3 hr
	250S125-18		3" glass fiber or mineral wool	(2) ¾" gypsum	(2) ¾" gypsum	4 hr
U431	362S125-18	16	Spray applied fire resistive material w/min. average density of 12 psf or 24 pcf.	¾" Plaster over metal lath (18 SWG wire)	¾" Portland cement plaster over metal lath (18 SWG wire)	4 hr
U435	162S125-18	24	Optional	(3) ½" gypsum board	(3) ½" gypsum board	3 hr
				(4) ½" gypsum board	(4) ½" gypsum board	4 hr
U450	362S125-18	16	Spray applied fire resistive material w/min. average density of 12 psf or 14 pcf.	(2) 5/8" gypsum,	(2) 5/8" gypsum,	3 hr
				(3) 5/8" gypsum,	(3) 5/8" gypsum,	4 hr
U455	350S125-33	24	3" batts or blankets	(3) ½" gypsum board	18 mil resilient channels, (2) ½" gypsum board	3 hr

**Table A1 – UL Non-Load Bearing Walls – Fire-Resistance (cont.)**  
(Not complete construction details; consult original source for more information)

Source	Stud Designation	Stud Spacing (in.)	Cavity Insulation		Interior Cover	Exterior Cover	Fire-Resistance
U475	250S125-18	16	Spray applied fire resistive material w/minimum thickness of:	2"	(2) 5/8" gypsum board	(2) 5/8" gypsum board	1 hr
	325S125-25			2-3/4"			2 hr
	362S125-25			3-1/4"			3 hr
	400S125-18			4"	(3) 5/8" gypsum board	(3) 5/8" gypsum board	4 hr
V414	362S162-33	16	3-1/2" fiber glass batts, 0.8 pcf		5/8" gypsum board	2" foam plastic board, metal brackets for ties, 4" wide brick veneers w/2" air space between veneer and foam	3 hr

**Table A2 – Gypsum Association Non-Load Bearing Walls – Fire-Resistance**  
(Not complete construction details; consult original source for more information)

Source	Stud Designation	Stud Spacing (in.)	Cavity Insulation	Interior Cover	Exterior Cover	Fire-Resistance
<b>Walls and Interior Partitions</b>						
WP1015	250S	24	None	1/4" & 5/8" gypsum	1/4" & 5/8" gypsum	1 hr
WP1021	250S	24	3" glass fiber	1/2" Type X gypsum	(2) 1/2" Type X gypsum	1 hr
WP1023	362S162	24	2-3/4" glass fiber	(2) 1/2" Type X gypsum	1/2" Type X gypsum	1 hr
WP1035	362S162-33	16	3" mineral fiber	1/2" cementitious	5/8" Type X gypsum	1 hr
WP1041	362S162-33	24	None	1/2" Type X gypsum, 1/2" fiber cement board	1/2" Type X gypsum, 1/2" fiber cement board	1 hr
WP1050	250S	24	None	1/4" gypsum, 1/2" Type X gypsum	1/4" gypsum, 1/2" Type X gypsum	1 hr
WP1051	250S	24	None	1/4" gypsum, 1/2" Type X gypsum	1/4" gypsum, 1/2" Type X gypsum	1 hr
WP1052	362S	24	None	(2) 5/8" Type X gypsum	(2) 5/8" Type X gypsum	1 hr
WP1053	250S	24	None	3/8" gypsum, 1/2" Type X gypsum	3/8" gypsum, 1/2" Type X gypsum	1 hr
WP1070	250S	24	1-1/2" mineral fiber	1/2" Type X gypsum	1/2" Type X gypsum	1 hr
WP1071	250S	24	2" mineral fiber	1/2" Type X gypsum	1/2" Type X gypsum	1 hr
WP1072	362S	24	None	5/8" Type X gypsum	5/8" Type X gypsum	1 hr
WP1073	250S	16	3-1/2" glass fiber	1/2" Type X gypsum	1/2" Type X gypsum	1 hr
WP1076	250S	24	2-3/4" glass fiber	5/8" Type X gypsum	5/8" Type X gypsum	1 hr
WP1081	362S	24	None	5/8" Type X gypsum	5/8" Type X gypsum	1 hr
WP1082	362S162-18	16	3" mineral fiber	5/8" Type X gypsum	5/8" Type X gypsum	1 hr
WP1085	250S	16	None	7/16" gypsum sand plaster, 1/16" lime gauging plaster, 3/8" Type X gypsum	7/16" gypsum sand plaster, 1/16" lime gauging plaster, 3/8" Type X gypsum	1 hr

**Table A2 – Gypsum Association Non-Load Bearing Walls – Fire-Resistance (cont.)**

(Not complete construction details; consult original source for more information)

Source	Stud Designation	Stud Spacing (in.)	Cavity Insulation	Interior Cover	Exterior Cover	Fire-Resistance
WP1090	162S	24	None	¼" gypsum, ½" Type X gypsum	¼" gypsum, ½" Type X gypsum	1 hr
WP1121	362S162-33	24	None	½" Type X gypsum, 1/8" fiber cement veneer	½" Type X gypsum, 1/8" fiber cement veneer	1 hr
WP1200	362S162	24	None	5/8" Type X gypsum	5/8" Type X gypsum	1 hr
WP1201	250S-33	16	None	5/8" Type X gypsum	5/8" Type X gypsum	1 hr
WP1240	250S	24	3" glass fiber	½" type X gypsum, 1/16" gypsum veneer	½" type X gypsum, 1/16" gypsum veneer	1 hr
WP1290	250S	24	None	½" gypsum sand plaster, ½" gypsum lath	½" gypsum sand plaster, ½" gypsum lath	1 hr
WP1295	362S162-33	24	None	5/8" Type X gypsum	½" Type X gypsum, ¼" fiber cement board	1 hr
WP1296	362S	16	3-1/2" mineral fiber	5/8" Type X gypsum	7/16" fiber cement board	1 hr
WP1340	162S	24	None	5/8" Type X gypsum	5/8" Type X gypsum	1 hr
WP1370	250S	24	None	½" gypsum sand plaster	½" gypsum sand plaster	1 hr
<b>Walls and Interior Partitions (cont.)</b>						
WP1400	162S	15	None	5/8" gypsum sand plaster over 3.4 lb. Metal lath	5/8" gypsum sand plaster over 3.4 lb. Metal lath	1 hr
WP1470	350S162-33	24	3" mineral fiber	(2) ½" Type X gypsum	Furring, (2) 1/2" Type X gypsum	2 hr
WP1505	250S	24	2-1/2" glass fiber	½" type X gypsum, 5/8" Type X gypsum	½" type X gypsum, 5/8" Type X gypsum	2 hr
WP1510	362S	24	2" glass fiber	(2) 5/8" Type X gypsum	5/8" & ½" Type X gypsum, ¼" or 3/8" gypsum	2 hr
WP1515	362S162-33	24	3" mineral fiber	½" cementitious, ¼" ceramic tile	(2) ½" type X gypsum	2 hr
WP1520	350S162-33	24	3" mineral fiber	½" Type X gypsum	Furring, (2) ½" Type X gypsum	2 hr
WP1521	362S	24	None	(2) ½" type X gypsum	(2) ½" type X gypsum	2 hr
WP1522	362S	24	None	(2) 5/8" Type X gypsum	(2) 5/8" Type X gypsum	2 hr
WP1530	162S	24	None	(2) ½" Type X gypsum	(2) ½" Type X gypsum	2 hr
WP1545 WP1546	250S	24	None	(2) ½" Type X gypsum	(2) ½" Type X gypsum	2 hr
WP1548	250S	24	None	(2) 5/8" Type X gypsum	(2) 5/8" Type X gypsum	2 hr
WP1560	250S	24	None	½" Type X gypsum, 3/32" gypsum veneer	½" Type X gypsum, 3/32" gypsum veneer	2 hr
WP1565	362S162-18	16	3" mineral fiber	(2) ½" Type X gypsum	½" Type X gypsum, ½" cementitious backer	2 hr
WP1570	350S	16	3" mineral fiber (2 pcf)	¾" Type X gypsum	¾" Type X gypsum	2 hr
WP1615	250S	24	None	(2) ½" Type X gypsum	(2) ½" Type X gypsum	2 hr

**Table A2 – Gypsum Association Non-Load Bearing Walls – Fire-Resistance (cont.)**

(Not complete construction details; consult original source for more information)

Source	Stud Designation	Stud Spacing (in.)	Cavity Insulation	Interior Cover	Exterior Cover	Fire-Resistance
<b>Walls and Interior Partitions (cont.)</b>						
WP1625	250S125-33	16	None	3/8" gypsum lath, 3/4" gypsum sand plaster	3/8" gypsum lath, 3/4" gypsum sand plaster	2 hr
WP1630	250S	24	None	(2) 1/2" Type X gypsum	(2) 1/2" Type X gypsum	2 hr
WP1632	250S	24	None	1/2" Type X gypsum, 1/2" glass matt gypsum	(2) 1/2" Type X gypsum	2 hr
WP1711	362S	24	None	(2) 5/8" Type X gypsum	(2) 5/8" Type X gypsum	2 hr
WP1940	250S125-33	16	None	(2) 5/8" Type X gypsum	(2) 5/8" Type X gypsum	2 hr
WP2800 WP2921 WP2922 WP2924	162S	24	None	(3) 1/2" Type X gypsum	(3) 1/2" Type X gypsum	3 hr
WP2930	162S	24	None	(2) 3/4" Type X gypsum	(2) 3/4" Type X gypsum	3 hr
WP2945	162S	24	None	(4) 1/2" Type X gypsum	(4) 1/2" Type X gypsum	4 hr
WP2960 WP2961 WP2963	162S	24	None	(4) 1/2" Type X gypsum	(4) 1/2" Type X gypsum	4 hr
WP2964	250S	24	2" mineral fiber (2pcf)	(2) 3/4" Type X gypsum	(2) 3/4" Type X gypsum	4 hr
WP2970	162S	24	None	(4) 1/2" Type X gypsum	(4) 1/2" Type X gypsum	4 hr
<b>Exterior Walls</b>						
WP8003	362S162-33	24	None	5/8" Type X gypsum	1/2" Type X gypsum, 1/4" fiber cement board	1 hr
WP8004	362S162	16	3-1/2" mineral fiber (3.0 pcf)	5/8" Type X gypsum	7/16" fiber cement board	1 hr
WP8005	362S	24	None	5/8" Type X glass mat gypsum	5/8" glass matt gypsum	1 hr
WP8122	362S162-43	16	None	5/8" Type X gypsum	5/8" Type X gypsum, EIFS w/2" XPS	1 hr
WP8123	362S162-43	24	None	5/8" Type X gypsum	5/8" Type X gypsum, EIFS w/4" XPS	1 hr
WP8202	362S162-43	24	None	(2) 5/8" Type X gypsum	(2) 5/8" Type X gypsum, EIFS w/4" XPS	2 hr
WP8205	362S162-33	16	3" mineral fiber	(2) 1/2" Type X gypsum	1/2" Type X gypsum, 1/2" cementitious	2 hr
WP8250	362S162-33	16	3" mineral fiber (2 pcf)	5/8" foil-backed gypsum	1/2" gypsum, stucco	2 hr
WP8310	400S162	16	3" mineral fiber (3.86 pcf)	1" gypsum-sand plaster over 3.4 lb. metal lath and 2mil vapor retarder	1" Portland cement plaster over 3.4 lb. metal lath & 3/4" channel bridging	2 hr
WP8325	362S162-33	16	3-1/4" perlite-portland cement-like back plaster spray	5/8" Type X gypsum	1" perlite plaster	2 hr

**Table A2 – Gypsum Association Non-Load Bearing Walls – Fire-Resistance (cont.)**

(Not complete construction details; consult original source for more information)

Source	Stud Designation	Stud Spacing (in.)	Cavity Insulation	Interior Cover	Exterior Cover	Fire-Resistance
WP5005	Double 162S-33, 3” apart	16	1-1/2” mineral fiber for each stud	5/8” Type X gypsum, 6”, 5/8” Type X gypsum cross braces between studs	1/2” cementitious board, 1/4” ceramic tiles	1 hr
WP5015	Double 162S-33, 6.25” apart	16	None	5/8” Type X gypsum, 9.5” long, Type X gypsum cross braces between studs	5/8” Type X gypsum	1 hr
WP5070	Double 162S-33, 3” apart	24	1-1/2” mineral fiber for each stud	1/2” Type X gypsum, 6” long- 1/2” Type X gypsum cross braces between studs	1/2” Type X Gypsum, 1/2” cementitious board, 1/4” ceramic tiles	2 hr
WP5105 WP5130	Double 162S, 6.25” apart	16	None	(2) 5/8” Type X gypsum, 6.25” long, Type X gypsum cross braces between studs	(2) 5/8” Type X gypsum	1 hr
<b>Movable and Office Partitions</b>						
WP5910	162S	24	None	3/8” gypsum, 1/2” Type X gypsum	3/8” gypsum, 1/2” Type X gypsum	1 hr
WP6010	250S	24	2-3/4” fiber glass	1/2” Type X gypsum, Aluminum battens, 7/8” wide, w/ 25 gauge steel track	1/2” Type X gypsum, Aluminum battens, 7/8” wide, w/ 25 gauge steel track	
WP6020			2” mineral fiber (3.7 pcf)			
WP6025			2” mineral fiber (3.8 pcf)			
WP6040			None	5/8” Type X gypsum, Aluminum battens, 7/8” wide, w/ 25 gauge steel track	5/8” Type X gypsum, Aluminum battens, 7/8” wide, w/ 25 gauge steel track	1 hr
WP6130			None	5/8” Type X gypsum, Aluminum battens over studs	5/8” Type X gypsum, Aluminum battens over studs	1 hr
WP6135	250S	24	2” mineral fiber (2.63 pcf)	1/2” Type X gypsum, Aluminum battens over studs	1/2” Type X gypsum, Aluminum battens over studs	1 hr
WP6250	250S	24	None	5/8” Type X gypsum, Aluminum battens over studs	5/8” Type X gypsum, Aluminum battens over studs	1 hr
WP6254	250S	24	1/2” Type X gypsum in cavity	1/2” Type X gypsum	1/2” Type X gypsum	1 hr
<b>Chase Walls</b>						
WP6800	250S, C-T studs	24	None	1” Type X gypsum over 2-1/2” floor & ceiling runners	5/8” Type X gypsum	1 hr
WP6900	250S, C-T studs	24	None	3/4” Type X gypsum over 2-1/4” floor & ceiling runners	5/8” Type X gypsum	1 hr
WP7000	250S, C-T studs	24	None	1” Type X gypsum over 2-1/2” floor & ceiling runners	5/8” Type X gypsum	1 hr
WP7051	250S, C-T studs	24	None	1” Type X gypsum over 2-1/2” floor & ceiling runners	(2) 1/2” Type X gypsum	2 hr



**Table A2 – Gypsum Association Non-Load Bearing Walls – Fire-Resistance (cont.)**

(Not complete construction details; consult original source for more information)

Source	Stud Designation	Stud Spacing (in.)	Cavity Insulation	Interior Cover	Exterior Cover	Fire-Resistance
WP7053	250S, C-T studs	24	3" mineral fiber (2 pcf)	1" Type X gypsum over 4" floor & ceiling J runners w/H sections	¾" Type X gypsum	2 hr
WP7125	162S	24	None	(4) 5/8" Type X gypsum	None	2-hr
WP7421	250S	24	None	¾" Type X gypsum between 2-1/4" floor & ceiling runners	(4) 5/8" Type X gypsum w/ resilient channels	3 hr
WP7451	250S	24	None	1" Type X gypsum between 2-1/2" floor & ceiling runners	(3) 5/8" Type X gypsum w/ resilient channels	3 hr
<b>Area Separation Walls</b>						
ASW1100	162S	24	None	(2) ½" Type X gypsum	(2) ½" Type X gypsum	2 hr
ASW1105	250S	24	None	(2) ½" Type X gypsum	(2) ½" Type X gypsum	2 hr

**Table A3 – Factory Mutual Systems -Non-Load Bearing Walls – Fire-Resistance**

(Not complete construction details; consult original source for more information)

Source	Stud Designation	Stud Spacing (in.)	Cavity Insulation	Interior Cover	Exterior Cover	Fire-Resistance
Wall1	362S137-22 363S162-22	24	None	5/8" gypsum	5/8" gypsum	1 hr
Wall 2	250S137-19	24	2" mineral wool (3.0lb/ft)	½" gypsum	½" gypsum	1 hr
Wall 3	250S137-22	24	None	½" gypsum	½" gypsum	1 hr
Wall 6	250S137-22	24	2" mineral wool (3.0lb/ft)	½" gypsum	½" gypsum	1 hr
Wall7	250S137-22	24/30	None	5/8" gypsum	5/8" gypsum	1 hr
Wall 8	250S137-22	24	2" mineral wool (3.7lb/ft)	½" gypsum	½" gypsum	1 hr
Wall 11	250S137-22	24	2" mineral wool (3.0lb/ft)	¼" & ½" gypsum	¼" & ½" gypsum	1 hr
Wall 20	250S150-27	24	5/8" gypsum panels between studs	5/8" gypsum	5/8" gypsum	1 hr
Wall 1	362S137-22	24	None	5/8" gypsum	(2) 5/8" gypsum	1-1/2 hr
Wall 1	250S137-43	24	None	(2) 5/8" gypsum, 54 mil steel bridging @ 16" o.c.	(2) 5/8" gypsum, 54 mil steel bridging @ 16" o.c.	2 hr
Wall 7	362S137-22	24	None	(2) 5/8" gypsum	(2) 5/8" gypsum	2 hr
Wall 14	250S137-43	24	None	(2) ½" gypsum	(2) ½" gypsum	2 hr

**Table A4 – UL Load Bearing Walls – Fire-Resistance**

(Not complete construction details; consult original source for more information)

Source	Stud Designation	Stud Spacing (in.)	Cavity Insulation	Interior Cover	Exterior Cover	Fire-Resistance
U404	350S162-33	24	3" thick mineral wool batts	5/8" gypsum board	1/2" cementitious backer board	1 hr
U407	350S162-33	16	3" mineral wool	1/2" cementitious backer board, ceramic tiles, and exterior finish system	1/2" cementitious backer board, ceramic tiles, and exterior finish system	1 hr
U432	350S162-33	24	Optional	5/8" gypsum board	5/8" gypsum board	1 hr
U434	350S162-33	24	Optional	5/8" gypsum	7/8" Portland cement plaster over metal lath	1 hr
U440	350S162-33	24	Optional	(2) 1/2" gypsum	(2) 1/2" gypsum	1 hr
U460	350S125-33	24	3" batts or blankets	5/8" gypsum	5/8" gypsum. 1" rigid ployiso. Insulation, 1/2" plywood	1 hr
U472	350S125-33	24	3-1/2" mineral wool batts	5/8" gypsum board	5/8" gypsum board, 1" polystyrene foamed plastic board, non-metallic fabric mesh, coating system	1 hr
U473	350S125-33	16	3" batts or blankets	5/8" gypsum board	1/2" cementitious board, 5/8" gypsum board	1 hr
U485	350S162-33	16	3" batts or blankets	1/2" cementitious board, 5/8" gypsum board	1/2" cementitious board, 5/8" gypsum board	1 hr
U487	362S162-33	24	3-1/2" mineral wool batts, 6 pcf density	(2) 5/8" gypsum board	5/8" mineral fiber board	1 hr
U418	350S162-43 or 550S162-43	24	3-1/2" glass fiber batts	5/8" gypsum	1/2" gypsum w/ aluminum, steel, brick, stucco, or 7/16" fiberboard	0.75 hr
				(2) 1/2" gypsum		1 hr
				(3) 1/2" gypsum		2 hr
U423	350S162-33	24	None	(1) 1/2" gypsum	(1) 1/2" gypsum	0.75 hr
				(1) 5/8" gypsum	(1) 5/8" gypsum	1 hr
				(2) 1/2" gypsum	(2) 1/2" gypsum	1-1/2 hr
			2" mineral wool batts	(2) 5/8" gypsum	(2) 5/8" gypsum	2 hr
			None	(3) 1/2" gypsum	(3) 1/2" gypsum	2 hr
				(2) 3/4" gypsum	(2) 3/4" gypsum	2 hr
U424	350S162-33	24	Optional	(1) 5/8" gypsum	a) 1/2" gypsum w/aluminum, vinyl or steel siding, brick veneer or stucco. b) 1/2" or 5/8" cementitious board (16" maximum stud spacing). c) Foamed plastic (1 pcf and R=3.8)	0.75 hr
				(2) 1/2" gypsum		1 hr
				(2) 5/8" gypsum		1-1/2 hr
				(3) 1/2" gypsum		2 hr
				(2) 3/4" gypsum		2 hr

**Table A4 – UL Load Bearing Walls – Fire-Resistance (cont.)**  
 (Not complete construction details; consult original source for more information)

Source	Stud Designation	Stud Spacing (in.)	Cavity Insulation	Interior Cover	Exterior Cover	Fire-Resistance
U425 (interior wall)	350S162-33	24	Glass fiber or mineral wool batts to fill cavity	½" gypsum	½" gypsum	0.75 hr
				5/8" gypsum	5/8" gypsum	1 hr
				(2) ½" gypsum	(2) ½" gypsum	1-1/2 hr
				(3) ½", (2) 5/8" or (2) ¾" gypsum	(3) ½", (2) 5/8" or (2) ¾" gypsum	2 hr
U425 (exterior wall)	350S162-33	24	Glass fiber or mineral wool batts to fill cavity	5/8" gypsum	½" or 5/8" gypsum w/ aluminum, steel, brick, stucco, 7/16" fiberboard or ½" cementitious	0.75 hr
				(2) ½" gypsum		1 hr
				(2) 5/8" gypsum		1-1/2 hr
				(3) ½" or (2) ¾" gypsum		2 hr
U477	362S162-33	24	3-1/2" mineral wool batts, 6 pcf density	(2) 5/8" gypsum board	5/8" mineral fiber board	2 hr
V415	562S162-33	16	3-1/2" mineral wool batts	33 mil furring channels, 2" thick structural cement fiber board, 5/8" Type X gypsum board	33 mil furring channels, 2" thick structural cement fiber board, 5/8" Type X gypsum board	2 hr
U426	350S162-33	24	Optional	(4) ½" gypsum	(4) ½" gypsum	3 hr
U462	350S125-33	24	Optional (1" to 3" thick mineral wool batts)	(4) 1/2" gypsum board	(4) 1/2" gypsum board	3 hr
U530	362S175-33	24	None	1-7/32" mineral fiber board, ½" by 5/16" expanded steel lath, 2.5 lbs/yd <sup>2</sup> , spray applied resistive material	1-7/32" mineral fiber board, ½" by 5/16" expanded steel lath, 2.5 lbs/yd <sup>2</sup> , spray applied resistive material	4 hr

**Table A5– Gypsum Association Load Bearing Walls – Fire-Resistance**  
 (Not complete construction details; consult original source for more information)

Source	Stud Designation	Stud Spacing (in.)	Cavity Insulation	Interior Cover	Exterior Cover	Fire-Resistance
WP1035	350S162-33	16	4-5/8" Batt insulation	½" cementitious	5/8" Type X gypsum	1 hr
WP1204	350S162-33	24	None	(2) ½" Type X gypsum	(2) 5/8" Type X gypsum	1 hr
WP1206	350S162-33	24	None	5/8" Type X gypsum	5/8" Type X gypsum	1 hr
WP1635	350S162-33	24	None	(3) ½" Type X gypsum	(3) ½" Type X gypsum	2 hr
WP1714	250S125-43	16	None	(2) 5/8" Type X gypsum	(2) 5/8" Type X gypsum	2 hr
WP1716	350S162-33	24	None	(2) ½" Type X gypsum	(2) ½" Type X gypsum	2 hr
WP8002	362S162-33	16	3" mineral fiber	½" cementitious board	5/8" Type X gypsum	1 hr

**Table A6 – Fire-Resistance of Floor Assemblies**

(Not complete construction details; consult original source for more information)

Source	Joist Size/ Designation	Stud Spacing (in.)	Cavity Insulation	Specifications	Fire-Resistance
<b>Underwriters Laboratories</b>					
G533	718S162-43	24	1" mineral wool (8 pcf) on top of furring channels	Top: 2" light weight concrete w/6x6-W1.4xW1.4 welded wire fabric and 19/32" corrugated steel deck; Bottom: 26 gauge furring channels, 1/2" gypsum on bottom	2 hr
G534	718S162-43	24	None	Top: 1-1/2" light weight concrete w/6x6-10/10SWG welded wire fabric and 19/32" corrugated steel deck; Bottom: 26 gauge furring channels, 1/2" gypsum on bottom	1 hr
G537	800S156-43	19	3-1/2" mineral wool loose fill insulation (2.8 pcf) blown between ceiling joists	Top: 1-1/2" light weight concrete w/6x6-W1.4xW1.4 welded wire fabric and 3/8" rib, 3.4 lbs/yd <sup>2</sup> expanded steel metal lath; Bottom: 350S125-43 ceiling joists spaced at 16" o.c. with 1/2" gypsum board	1 hr
G704	800S162-43	19	8" glass fiber insulation	Top: 1-1/2" light weight concrete w/6x6-W1.4xW1.4 welded wire fabric and 3/8" rib, 3.4 lbs/yd <sup>2</sup> expanded steel metal lath; Bottom: Diamond mesh metal lath (3.4 lb/sq yd expanded steel), spray-applied fire resistive material (2-1/2" plaster)	4 hr
G802	Hambro System	50-1/2 or 60	None	3500-psi normal weight concrete or lightweight concrete (thickness vary from 3" to 4-1/2" based on steel spacing). Concrete may be cast over removable plywood forms or corrugated steel deck. The undersides of concrete and joists are finished with spray-applied fire resistive material of 0" to 2-1/2".	1 hr- 3 hr
L524	700S162-43	24	None	Top: 19/32" plywood or 3/4" or 1" floor topping mixture over 15/32" plywood or 3/4" gypsum board over 19/32" plywood. Bottom: (2) 1/2" gypsum board	1 hr
L527	938S162-54	24	None	Top: 3/4" plywood on top; Furring channels and Bottom: 24 gauge, 1/2" deep resilient channels spaced at 16" o.c. and (2) 5/8" gypsum board	1-1/2 hr
L543	800S156-43	19	3-1/2" mineral wool loose fill insulation (2.8 pcf) blown between ceiling joists	Top: 23/32" plywood Bottom: 362S125-43 ceiling joists spaced at 16" o.c. with two layers of 1/2" gypsum board	1 hr

**Table A6 – Fire-resistance of Floor Assemblies (cont.)**

(Not complete construction details; consult original source for more information)

Source	Joist Size/ Designation	Stud Spacing (in.)	Cavity Insulation	Specifications	Fire- Resistance
<b>Underwriters Laboratories</b>					
P511	725S175-43	24	None	Top: Crushed stone at roof covering, roof covering (or roof membrane), insulating concrete (such as Vermiculite concrete, Cellular concrete, or Perlite concrete), 1" to 8" thick foamed plastic, and 9/16" galvanized corrugated steel roof deck. Bottom: 26 gauge furring channels (2-5/8" wide x 7/8" deep) and two layers of 1/2" gypsum board.	1 hr
P512	725S175-43	24	None	Top: Roof covering (or roof membrane), metal roof deck, 2-7/16" thick mineral and fiber board, hot asphalt or cold tar pitch, 2-7/16" thick mineral and fiber board. Bottom: Two layers of 1/2" gypsum board.	1 hr
P518	800S156-43	24	8" thick glass fiber insulation installed between roof joists	Top: Roof covering (or roof membrane), 28 gauge corrugated steel roof deck (9/16" deep), 1/2" gypsum board Bottom: Bridging and 1/2" gypsum board.	1 hr
<b>Gypsum Association</b>					
FC1145	600S162-43	24		25 gauge corrugated metal deck & 2" light-weight (105 pcf) concrete on top; 1/2" Type X gypsum w/furring channels on bottom	1 hr
FC2116	725S162-43	24	None	28 gauge corrugated metal deck & 2-1/2" concrete on top; (2) 5/8" Type X gypsum	2 hr
FC4502	700S162-43	24	None	5/8" T&G plywood on top; (2) 1/2" Type X gypsum on bottom	1 hr
FC4503	600S162-54	24	None	5/8" T&G plywood on top; (2) 1/2" Type X gypsum on bottom	1 hr
<b>Factory Mutual Systems</b>					
FM J.I. 2C9Q7 AC	TJI	24	None	Elastizell concrete, plywood subfloor and two layers of gypsum ceiling board	1 hr
FM J.I. 2C9Q7 AC		24	None	Corrugated metal deck over steel floor joist, Elastizell concrete and resilient furring channels	1 hr

**Table A7 – Gypsum Association Non-Load Bearing Walls – STC Rating**  
(Not complete construction details; consult original source for more information)

Source	Stud Designation	Stud Spacing (in.)	Cavity Insulation	Interior Cover	Exterior Cover	STC Rating (dB)
<b>Walls and Interior Partitions</b>						
WP1015	250S	24	1-1/2" mineral fiber	1/4" & 5/8" gypsum	1/4" & 5/8" gypsum	55-59
WP1021	250S	24	3" glass fiber	1/2" Type X gypsum	(2) 1/2" Type X gypsum	50-54
WP1023	362S162	24	2-3/4" glass fiber	(2) 1/2" Type X gypsum	1/2" Type X gypsum	50-54
WP1041	362S162-33	24	None	1/2" Type X gypsum, 1/2" fiber cement board	1/2" Type X gypsum, 1/2" fiber cement board	50-54
WP1050	250S	24	2" glass fiber	1/4" gypsum, 1/2" Type X gypsum	1/4" gypsum, 1/2" Type X gypsum	50-54
WP1051	250S	24	2" glass fiber	1/4" gypsum, 1/2" Type X gypsum	1/4" gypsum, 1/2" Type X gypsum	50-54
WP1052	362S	24	3-1/2" glass fiber	(2) 5/8" Type X gypsum	(2) 5/8" Type X gypsum	50-54
WP1053	250S	24	3-1/2" glass fiber	3/8" gypsum, 1/2" Type X gypsum	3/8" gypsum, 1/2" Type X gypsum	50-54
WP1070	250S	24	2" mineral fiber	1/2" Type X gypsum	1/2" Type X gypsum	45-49
WP1071	250S	24	2" mineral fiber	1/2" Type X gypsum	1/2" Type X gypsum	45-49
WP1072	362S	24	3-1/2" glass fiber	5/8" Type X gypsum	5/8" Type X gypsum	45-49
WP1073	250S	16	3-1/2" glass fiber	1/2" Type X gypsum	1/2" Type X gypsum	45-49
WP1076	250S	24	2-3/4" glass fiber	5/8" Type X gypsum	5/8" Type X gypsum	45-49
WP1081	362S	24	3" mineral fiber	5/8" Type X gypsum	5/8" Type X gypsum	45-49
WP1082	362S162-18	16	3" mineral fiber	5/8" Type X gypsum	5/8" Type X gypsum	45-49
WP1085	250S	16	1" mineral fiber	7/16" gypsum sand plaster, 1/16" lime gauging plaster, 3/8" Type X gypsum	7/16" gypsum sand plaster, 1/16" lime gauging plaster, 3/8" Type X gypsum	45-49
WP1090	162S	24	None	1/4" gypsum, 1/2" Type X gypsum	1/4" gypsum, 1/2" Type X gypsum	45-49
WP1121	362S162-33	24	None	1/2" Type X gypsum, 1/8" fiber cement veneer	1/2" Type X gypsum, 1/8" fiber cement veneer	45-49
WP1200	362S162-18	24	None	5/8" Type X gypsum	5/8" Type X gypsum	40-44
WP1201	250S-33	16	None	5/8" Type X gypsum	5/8" Type X gypsum	40-44
WP1240	250S	24	3" glass fiber	1/2" type X gypsum, 1/16" gypsum veneer	1/2" type X gypsum, 1/16" gypsum veneer	40-44
WP1290	250S	24	None	1/2" gypsum sand plaster, 1/2" gypsum lath	1/2" gypsum sand plaster, 1/2" gypsum lath	40-44
WP1295	362S162-33	24	None	5/8" Type X gypsum	1/2" Type X gypsum, 1/4" fiber cement board	40-44
WP1296	362S	16	3-1/2" mineral fiber	5/8" Type X gypsum	7/16" fiber cement board	40-44
WP1340	162S	24	None	5/8" Type X gypsum	5/8" Type X gypsum	35-39

**Table A6 – Gypsum Association Non-Load Bearing Walls – STC Rating (cont.)**

(Not complete construction details; consult original source for more information)

Source	Stud Designation	Stud Spacing (in.)	Cavity Insulation	Interior Cover	Exterior Cover	STC Rating (dB)
<b>Walls and Interior Partitions (cont.)</b>						
WP1370	250S	24	None	½” gypsum sand plaster	½” gypsum sand plaster	35-39
WP1400	162S	15	None	5/8” gypsum sand plaster over 3.4 lb. Metal lath	5/8” gypsum sand plaster over 3.4 lb. Metal lath	35-39
WP1470	350S162-33	24	3” mineral fiber	(2) ½” Type X gypsum	Furring, (2) ½” Type X gypsum	55-59
WP1505	250S	24	2-1/2” glass fiber	½” type X gypsum, 5/8” Type X gypsum	½” type X gypsum, 5/8” Type X gypsum	55-59
WP1510	362S	24	2” glass fiber	(2) 5/8” Type X gypsum	5/8” & ½” Type X gypsum, ¼” or 3/8” gypsum	55-59
WP1515	362S162-33	24	3” mineral fiber	½” cementitious, ¼” ceramic tile	(2) ½” type X gypsum	55-59
WP1520	350S162-33	24	3” mineral fiber	½” Type X gypsum	Furring, (2) ½” Type X gypsum	55-59
WP1521	362S	24	3-1/2” glass fiber	(2) ½” Type X gypsum	(2) ½” Type X gypsum	55-59
WP1522	362S	24	3-1/2” glass fiber	(2) 5/8” Type X gypsum	(2) 5/8” Type X gypsum	55-59
WP1530	162S	24	1-1/2” glass fiber	(2) ½” Type X gypsum	(2) ½” Type X gypsum	50-54
WP1545 WP1546	250S	24	1-1/2” glass fiber	(2) ½” Type X gypsum	(2) ½” Type X gypsum	50-54
WP1548	250S	24	2-1/2” glass fiber	(2) 5/8” Type X gypsum	(2) 5/8” Type X gypsum	50-54
WP1560	250S	24	1-1/2” glass fiber	½” Type X gypsum, 3/32” gypsum veneer	½” Type X gypsum, 3/32” gypsum veneer	50-54
WP1565	362S162-18	16	3” mineral fiber	(2) ½” Type X gypsum	½” Type X gypsum, ½” cementitious backer	50-54
WP1570	350S	16	3” mineral fiber (2 pcf)	¾” Type X gypsum	¾” Type X gypsum	50-54
WP1615	250S	24	None	(2) ½” Type X gypsum	(2) ½” Type X gypsum	45-49
WP1625	250S125-33	16	2” mineral fiber (3.4 pcf)	3/8” gypsum lath, ¾” gypsum sand plaster	3/8” gypsum lath, ¾” gypsum sand plaster	45-49
WP1630	250S	24	None	(2) ½” Type X gypsum	(2) ½” Type X gypsum	45-49
WP1632	250S	24	None	½” Type X gypsum, ½” glass matt gypsum	(2) ½” Type X gypsum	45-49
WP1711	362S	24	None	(2) 5/8” Type X gypsum	(2) 5/8” Type X gypsum	40-44
WP2800	152S	24	1-1/2” mineral fiber	(3) ½” Type X gypsum	(3) ½” Type X gypsum	55-59FSTC
WP2921 WP2922 WP2924	162S	24	1-1/2” mineral fiber	(3) ½” Type X gypsum	(3) ½” Type X gypsum	50-54



**Table A6 – Gypsum Association Non-Load Bearing Walls – STC Rating (cont.)**

(Not complete construction details; consult original source for more information)

Source	Stud Designation	Stud Spacing (in.)	Cavity Insulation	Interior Cover	Exterior Cover	STC Rating (dB)
<b>Walls and Interior Partitions (cont.)</b>						
WP2945	162S	24	1-1/2" mineral fiber	(4) 1/2" Type X gypsum	(4) 1/2" Type X gypsum	60-64
WP2960 WP2961 WP2963	162S	24	1-1/2" glass fiber	(4) 1/2" Type X gypsum	(4) 1/2" Type X gypsum	55-59
WP2964	250S	24	2" mineral fiber (2pcf)	(2) 3/4" Type X gypsum	(2) 3/4" Type X gypsum	55-59
WP2970	162S	24	None	(4) 1/2" Type X gypsum	(4) 1/2" Type X gypsum	50-54
<b>Chase Walls</b>						
WP5005	Double 162S-33	16	1-1/2" mineral fiber for each stud	5/8" Type X gypsum, 6" long, 5/8" Type X gypsum cross braces between studs	1/2" cementitious board, 1/4" ceramic tiles	60-64 FSTC
WP5015	Double 162S-33, 6.25" apart	16	1-1/2" mineral fiber for each stud	5/8" Type X gypsum, 9.5" long, 5/8" Type X gypsum cross braces between studs	5/8" Type X gypsum	50-54
WP5070	Double 162S-33	24	1-1/2" mineral fiber for each stud	1/2" Type X gypsum, 6" long- 1/2" Type X gypsum cross braces between studs	1/2" Type X Gypsum, 1/2" cementitious board, 1/4" ceramic tiles	60-64 FSTC
WP5105	Double 162S, 6.25" apart	16	3-1/2" mineral fiber	(2) 5/8" Type X gypsum, 6.25" long, Type X gypsum cross braces between studs	(2) 5/8" Type X gypsum	55-59
WP5130	Double 162S, 6.25" apart	16	None	(2) 5/8" Type X gypsum, 6.25" long, Type X gypsum cross braces between studs	(2) 5/8" Type X gypsum	50-54
<b>Movable and Office Partitions</b>						
WP5910	162S	24	2-3/4" fiber glass	3/8" gypsum, 1/2" Type X gypsum	3/8" gypsum, 1/2" Type X gypsum	50-54
WP6010	250S	24	2-3/4" fiber glass	1/2" Type X gypsum, Aluminum battens, 7/8" wide, w/ 25 gauge steel track	1/2" Type X gypsum, Aluminum battens, 7/8" wide, 25 gauge steel track	45-49
WP6020			2" mineral fiber (3.7 pcf)			
WP6025			2" mineral fiber (3.8 pcf)			
WP6040	250S	24	3" glass fiber	5/8" Type X gypsum, Aluminum battens, 7/8" wide, w/ 25 gauge steel track	5/8" Type X gypsum, Aluminum battens, 7/8" wide, 25 gauge steel track	40-44
WP6130			2" glass fiber			
WP6135	250S	24	2" mineral fiber (2.63 pcf)	1/2" Type X gypsum, Aluminum battens over studs	1/2" Type X gypsum, Aluminum battens over studs	40-44
WP6250	250S	24	None	5/8" Type X gypsum, Aluminum battens over studs	5/8" Type X gypsum, Aluminum battens over studs	35-39

**Table A6 – Gypsum Association Non-Load Bearing Walls – STC Rating (cont.)**

(Not complete construction details; consult original source for more information)

Source	Stud Designation	Stud Spacing (in.)	Cavity Insulation	Interior Cover	Exterior Cover	STC Rating (dB)
<b>Walls and Interior Partitions (cont.)</b>						
WP6254	250S	24	½" Type X gypsum in cavity	½" Type X gypsum	½" Type X gypsum	35-39
<b>Shaft Walls</b>						
WP6800	250S, C-T studs	24	2-1/2" glass fiber	1" Type X gypsum over 2-1/2" floor & ceiling runners	5/8" Type X gypsum	45-49
WP6900	250S, C-T studs	24	1" glass fiber	¾" Type X gypsum over 2-1/4" floor & ceiling runners	5/8" Type X gypsum	40-44
WP7000	250S, C-T studs	24	None	1" Type X gypsum over 2-1/2" floor & ceiling runners	5/8" Type X gypsum	45-49
WP7051	250S, C-T studs	24	1-7/8" glass fiber	1" Type X gypsum over 2-1/2" floor & ceiling runners	(2) ½" Type X gypsum	50-54
WP7053	250S, C-T studs	24	3" mineral fiber (2 pcf)	1" Type X gypsum over 4" floor & ceiling J runners w/H sections	¾" Type X gypsum	50-54
WP7125	162S	24	None	(4) 5/8" Type X gypsum	None	35-39
WP7421	250S	24	1" glass fiber	¾" Type X gypsum between 2-1/4" floor & ceiling runners	(4) 5/8" Type X gypsum w/ resilient channels	50-54
WP7451	250S	24	1" glass fiber	1" Type X gypsum between 2-1/2" floor & ceiling runners	(3) 5/8" Type X gypsum w/ resilient channels	45-49
<b>Area Separation Walls</b>						
ASW1100	162S	24	1-1/2" mineral fiber	(2) ½" Type X gypsum	(2) ½" Type X gypsum	50-54
ASW1105	250S	24	1-1/2" mineral fiber	(2) ½" Type X gypsum	(2) ½" Type X gypsum	50-54

**Table A7 – Gypsum Association Load Bearing Walls – STC rating**

Source	Stud Designation	Stud Spacing (in.)	Cavity Insulation	Interior Cover	Exterior Cover	STC Rating (dB)
WP1204	350S162-33	24	None	(2) ½" Type X gypsum	(2) 5/8" Type X gypsum	40-44
WP1206	350S162-33	24	None	5/8" Type X gypsum	5/8" Type X gypsum	40-44
WP1635	350S162-33	24	None	(3) ½" Type X gypsum	(3) ½" Type X gypsum	45-49
WP1714	250S125-43	16	None	(2) 5/8" Type X gypsum	(2) 5/8" Type X gypsum	40-44
WP1716	350S162-33	24	None	(2) ½" Type X gypsum	(2) ½" Type X gypsum	40-44
WP8002	362S162-33	24	3" mineral fiber batts	5/8" gypsum	5/8" gypsum, ½" cementitious board	-

**Table A7 – Other Fire-Rated and STC Rated Assemblies**  
(Not complete construction details; consult original source for more information)

Source	Stud Size and Spacing	Bearing Condition	Cavity Insulation	Interior Cover	Exterior Cover	Fire-Resistance	STC Rating (dB)
WP1200 RAL-TL93-70W	362S162-18 @ 24" o.c.	NLB	1-1/2" Cocoon insulation	5/8" Type X gypsum	5/8" Type X gypsum	1 hr	50
RAL-TL98-7	250S162-18 @ 24" o.c.	NLB	Full cavity Cocoon insulation	5/8" Type X gypsum	5/8" Type X gypsum	1 hr	50
WP1711	362S162-18 @ 24" o.c.	NLB	Full cavity Cocoon insulation	(2) 5/8" Type X gypsum	(2) 5/8" Type X gypsum	2 hr	58
U412 WP1548	250S162-18 @ 24" o.c.	NLB	Full cavity Cocoon insulation	(2) 5/8" Type C gypsum	(2) 5/8" Type C gypsum	2 hr	58
U419	600S162-18 @ 16" o.c.	NLB	Full cavity Cocoon insulation	(3) 5/8" Type C gypsum	(3) 5/8" Type C gypsum	3 hr	65
Nu-Wool	600S @ 16" o.c.	NLB	3-5/8" WALLSEAL	Resilient channel, 5/8" gypsum board	5/8" gypsum board	-	54
Nu-Wool	350S @ 16" o.c.	NLB	3-1/2" WALLSEAL	Resilient channel, (2) 5/8" Type X gypsum board	(2) 5/8" Type X gypsum board	-	60
Nu-Wool	350S @ 16" o.c.	NLB	3-1/2" WALLSEAL	Resilient channel, (2) 1/2" Type X gypsum board	(2) 1/2" Type X gypsum board	-	58
Nu-Wool	350S @ 16" o.c.	NLB	3-1/2" WALLSEAL	Resilient channel, (1) 5/8" Type X gypsum board	(1) 5/8" Type X gypsum board	-	52
Nu-Wool	350S @ 16" o.c.	NLB	3-1/2" WALLSEAL	Resilient channel, 1/2" gypsum board	1/2" gypsum board	-	46
Johns Manville	362S @ 16" o.c.	NLB	2" fiberglass (0.75 pcf)	1/2" gypsum board	1/2" gypsum board	-	46
Johns Manville	362S @ 16" o.c.	NLB	2" rockwool (2.0pcf)	1/2" gypsum board	1/2" gypsum board	-	45
Hardirock (U454)	350S125-33	24	3" mineral fiber insulation (2 pcf)	(2) 1/2" Type C gypsum board	Resilient channels, (2) 1/2" Type C gypsum board	2 hr	55-59
Hardirock (U435)	152S125-18	16/24	1-1/2" glass fiber	(3) 1/2" Type C gypsum board	(3) 1/2" Type C gypsum board	3 hr	50-54 (FSTC)

**Table A8 – STC/IIC Rated Floor Assemblies**

(Not complete construction details; consult original source for more information)

Source	Joist Size/ Designation	Stud Spacing (in.)	Cavity Insulation	Specifications	STC/IIC Rating (dB)
<b>NAIMA</b>					
Figure 27	725S162-43	24	3-1/2" glass fiber	Carpet and pad, 3/4" T&G plywood subwood subfloor on top, resilient channel, 5/8" gypsum on bottom	56/71

## **Appendix B**

### **List of Canadian Fire- and Sound-Rated Steel Assemblies**

## Residential Steel Framing – Fire and Acoustic Details

---

The following is a comprehensive list of Canadian fire-ratings, STC ratings, and IIC ratings of cold-formed steel wall and floor assemblies. All assemblies shown in this Appendix are not complete construction details. Original source should be consulted for complete and detailed information.

- 1 layer gypsum board
- Steel studs (0.46 mm, 0.018 in. thick)
- Insulation
- 2 layers gypsum board

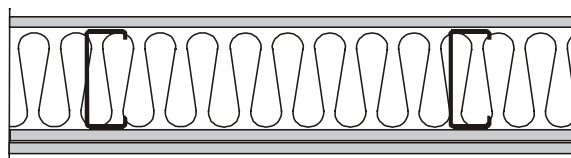

**Table B1 – Non-Load Bearing Walls – Fire-Rated Assemblies**

Test No.	Stud Size (mm)	Stud Spacing (mm)	Insulation		Gypsum Board		Fire Endurance (min.)
			Type	Thickness (mm)	Type	Thickness (mm)	
F-07	31 x 92	610	None	-	Type X	12.7	65
F-09	31 x 92	610	Glass fiber	92	Type X	12.7	65
F-10	31 x 92	610	Mineral fiber (584 mm wide)	92	Type X	12.7	60
F-10B	31 x 92	610	Mineral fiber (615 mm wide)	92	Type X	12.7	100
F-11	31 x 92	610	Cellulose	92	Type X	12.7	62

Notes:

Reference report IRC-IR-675

Metric conversion: 1 in. = 25.4 mm

- 2 layers gypsum board
- Steel studs (0.46 mm, 0.018 in. thick)
- Insulation
- 2 layers gypsum board

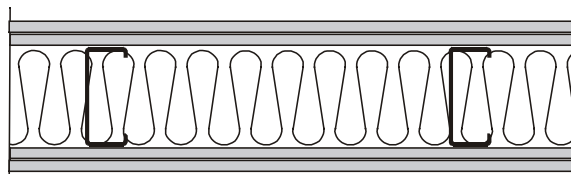

**Table B2 – Non-Load Bearing Walls – Fire-Rated Assemblies**

Test No.	Stud Size (mm)	Stud Spacing (mm)	Insulation		Gypsum Board		Fire Endurance (min.)
			Type	Thickness (mm)	Type	Thickness (mm)	
F-03	31 x 92	610	None	-	RL	12.7	63
F-05	31 x 92	610	None	-	RH	12.7	69

Notes:

Reference report IRC-IR-674

Metric conversion: 1 in. = 25.4 mm, 1 lb = 0.445 kg, 1 ft = 0.305 m

RL = low density gypsum board (7.35 kg/m<sup>3</sup>). RH = low density gypsum board (7.80 kg/m<sup>3</sup>)

- 1 layer gypsum board
- Steel studs (0.46 mm, 0.018 in. thick)
- Insulation
- 1 layer gypsum board

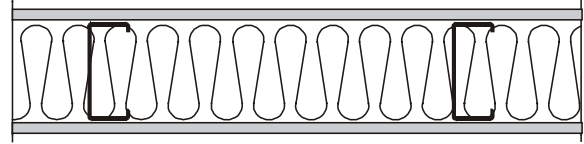

**Table B3 – Non-Load Bearing Walls – STC Rating**

Test No.	Stud Size (mm)	Stud Spacing (mm)	Insulation		Gypsum Board		STC Rating
			Type	Thickness (mm)	Type	Thickness (mm)	
<b>31 x 64 mm Non-load bearing Studs</b>							
057	31 x 64	406	None	-	Type X	15.9	35
032	31 x 64	610	None	-	Type X	15.9	35
058	31 x 64	406	Glass Fiber (G1)	64	Type X	15.9	39
064	31 x 64	406	Mineral Fiber (M1)	64	Type X	12.7	36
061	31 x 64	406	Mineral Fiber (M1)	64	Type X	15.9	38
069, 070	31 x 64	406	Mineral Fiber (M1)	64	Regular	12.7	33, 34
067	31 x 64	406	Mineral Fiber (M2)	64	Type X	12.7	35
059	31 x 64	406	Mineral Fiber (M2)	64	Type X	15.9	36
060	31 x 64	406	Mineral Fiber (M3)	57	Type X	15.9	36
068	31 x 64	406	Mineral Fiber (M3)	57	Regular	12.7	36
038	31 x 64	610	Glass Fiber (G1)	64	Type X	12.7	45
033, 073	31 x 64	610	Glass Fiber (G1)	64	Type X	15.9	44, 44
041, 043, 044	31 x 64	610	Glass Fiber (G1)	64	Regular	12.7	42, 43, 43
047	31 x 64	610	Mineral Fiber (M1)	64	Type X	12.7	43
034	31 x 64	610	Mineral Fiber (M1)	64	Type X	15.9	42

Notes:

Reference report IRC-IR-761



- 1 layer gypsum board
- Steel studs (0.46 mm, 0.018 in. thick)
- Insulation
- 1 layer gypsum board

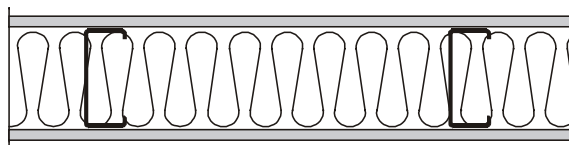
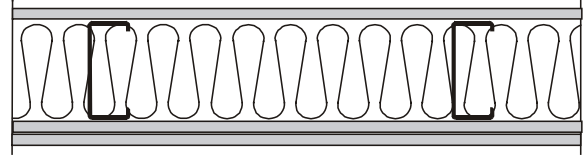

**Table B4 – Non-Load Bearing Walls – STC Rating**

Test No.	Stud Size (mm)	Stud Spacing (mm)	Insulation		Gypsum Board		STC Rating
			Type	Thickness (mm)	Type	Thickness (mm)	
<b>31 x 92 mm Non-load bearing Studs</b>							
418	31 x 92	406	None	-	Type X	15.9	38
376	31 x 92	610	None	-	Type X	15.9	38
422, 425, 344	31 x 92	406	Glass Fiber (G1)	89	Type X	12.7	45, 45, 46
419, 443, 444, 074, 075, 325, 326, 352, 360, 026, 027, 028, 029	31 x 92	406	Glass Fiber (G1)	89	Type X	15.9	47, 45, 44, 47, 46, 49, 49, 46, 46, 46
428, 347, 361, 365	31 x 92	406	Glass Fiber (G1)	89	Regular	12.7	42, 41, 39, 40
445, 327, 328	31 x 92	406	Mineral Fiber (M1)	90	Type X	15.9	46, 47, 47
343	31 x 92	406	Mineral Fiber (M2)	40	Type X	12.7	40
340	31 x 92	406	Mineral Fiber (M2)	40	Type X	15.9	41
002, 335, 336	31 x 92	406	Mineral Fiber (M2)	75	Type X	15.9	42, 45, 44
080	31 x 92	406	Mineral Fiber (M2)	90	Type X	12.7	40
001	31 x 92	406	Mineral Fiber (M2)	90	Type X	15.9	43
081	31 x 92	406	Mineral Fiber (M3)	90	Type X	12.7	39
339	31 x 92	406	Mineral Fiber (M3)	83	Type X	12.7	40
338, 003	31 x 92	406	Mineral Fiber (M3)	83	Type X	15.9	41, 39
439	31 x 92	406	Cellulose (C1)	40	Type X	15.9	45
049	31 x 92	406	Cellulose (C1)	90	Type X	15.9	45
438	31 x 92	406	Cellulose (C2)	90	Type X	15.9	44
413	31 x 92	610	Glass Fiber (G1)	90	Regular	12.7	47
410	31 x 92	610	Glass Fiber (G1)	90	Type X	12.7	48
348, 367, 399, 324	31 x 92	610	Glass Fiber (G1)	90	Type X	15.9	48, 49, 48, 50
396	31 x 92	610	Mineral Fiber (M2)	40	Type X	15.9	45
026	31 x 92	610	Cellulose (C2)	90	Type X	12.7	48
<b>31 x 152 mm Non-load bearing Studs</b>							
299	31 x 152	610	Glass Fiber (G1)	152	Type X	12.7	52
298	31 x 152	610	Glass Fiber (G1)	152	Type X	15.9	51

Notes:

Reference report IRC-IR-761

- 1 layer gypsum board
- Steel studs (0.46 mm, 0.018 in. thick)
- Insulation
- 2 layers gypsum board



**Table B5 – Non-Load Bearing Walls – STC Rating**

Test No.	Stud Size (mm)	Stud Spacing (mm)	Insulation		Gypsum Board		STC Rating
			Type	Thickness (mm)	Type	Thickness (mm)	
<b>31 x 64 mm Non-load bearing Studs</b>							
065	31 x 64	406	Mineral Fiber (M1)	64	Type X	12.7	42
062	31 x 64	406	Mineral Fiber (M1)	64	Type X	15.9	45
071	31 x 64	406	Mineral Fiber (M1)	64	Regular	12.7	38
039	31 x 64	610	Glass Fiber (G1)	64	Type X	12.7	51
036	31 x 64	610	Glass Fiber (G1)	64	Type X	15.9	51
035	31 x 64	610	Glass Fiber (G1)	64	(2) Type X (1) Reg.	15.9/12.7	49
045	31 x 64	610	Glass Fiber (G1)	64	Regular	12.7	49
055	31 x 64	610	Mineral Fiber (M1)	64	Type X	12.7	49
048	31 x 64	610	Mineral Fiber (M1)	64	(2) Type X (1) Regular	12.7	48

Notes:

Reference report IRC-IR-761

Metric conversion: 1 in. = 25.4 mm

## Residential Steel Framing – Fire and Acoustic Details

- 1 layer gypsum board
- Steel studs (0.46 mm, 0.018 in. thick)
- Insulation
- 2 layers gypsum board

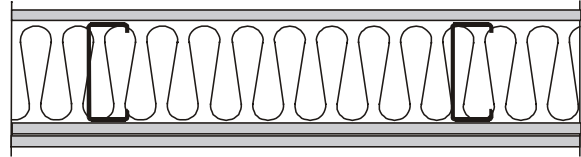

**Table B6 – Non-Load Bearing Walls – STC Rating**

Test No.	Stud Size (mm)	Stud Spacing (mm)	Insulation		Gypsum Board		STC Rating
			Type	Thickness (mm)	Type	Thickness (mm)	
<b>31 x 92 mm Non-load bearing Studs</b>							
423, 426, 345	31 x 92	406	Glass Fiber (G1)	92	Type X	12.7	51, 50, 51
420, 350	31 x 92	406	Glass Fiber (G1)	92	Type X	15.9	52, 52
429, 348, 364, 366	31 x 92	406	Glass Fiber (G1)	92	Regular	12.7	48, 47, 44, 46
329	31 x 92	406	Mineral Fiber (M1)	92	Type X	15.9	53
341	31 x 92	406	Mineral Fiber (M2)	40	Type X	15.9	47
333	31 x 92	406	Mineral Fiber (M2)	75	Type X	15.9	50
337	31 x 92	406	Mineral Fiber (M3)	83	Type X	15.9	46
440	31 x 92	406	Cellulose (C1)	40	Type X	15.9	51
050	31 x 92	406	Cellulose (C1)	90	Type X	15.9	49
437	31 x 92	406	Cellulose (C2)	90	Type X	15.9	49
411	31 x 92	610	Glass Fiber (G1)	92	Type X	12.7	52
415	31 x 92	610	Glass Fiber (G1)	92	Regular	12.7	51
368	31 x 92	610	Glass Fiber (G1)	92	Type X	15.9	54
370	31 x 92	610	Glass Fiber (G1)	92	(2) Type X (1) Regular	15.9/12.7	55
397	31 x 92	610	Mineral Fiber (M2)	40	Type X	15.9	51
027	31 x 92	610	Cellulose (C1)	92	Type X	12.7	53

Notes:

Reference report IRC-IR-761

Metric conversion: 1 in. = 25.4 mm

## Residential Steel Framing – Fire and Acoustic Details

- 2 layers gypsum board
- Steel studs (0.46 mm, 0.018 in. thick)
- Insulation
- 2 layers gypsum board

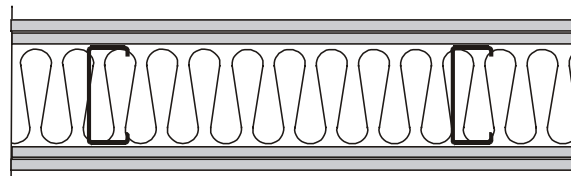

**Table B7 – Non-Load Bearing Walls – STC Rating**

Test No.	Stud Size (mm)	Stud Spacing (mm)	Insulation		Gypsum Board		STC Rating
			Type	Thickness (mm)	Type	Thickness (mm)	
<b>31 x 64 mm Non-load bearing Studs</b>							
072	31 x 64	406	Mineral Fiber (M1)	64	Regular	12.7	44
063	31 x 64	406	Mineral Fiber (M1)	64	Type X	15.9	52
040	31 x 64	610	Glass Fiber (G1)	64	Type X	12.7	55
046	31 x 64	610	Glass Fiber (G1)	64	Regular	12.7	52
037	31 x 64	610	Glass Fiber (G1)	64	Type X	15.9	55
056	31 x 64	610	Mineral Fiber (M1)	64	Type X	12.7	54
<b>31 x 92 mm Non-load bearing Studs</b>							
424, 427, 346	31 x 92	406	Glass Fiber (G1)	92	Type X	12.7	55, 55, 52
421, 351	31 x 92	406	Glass Fiber (G1)	92	Type X	15.9	56, 56
430, 349, 363, 367	31 x 92	406	Glass Fiber (G1)	92	Regular	12.7	53, 49, 48, 53
441	31 x 92	406	Cellulose (C1)	40	Type X	15.9	53
331, 332	31 x 92	406	Mineral Fiber (M1)	92	Type X	15.9	55, 55
342	31 x 92	406	Mineral Fiber (M2)	40	Type X	15.9	52
077, 334	31 x 92	406	Mineral Fiber (M2)	75	Type X	15.9	52, 54
051	31 x 92	406	Cellulose (C1)	90	Type X	15.9	52
435, 436	31 x 92	406	Cellulose (C2)	92	Type X	(1) 12.7/ (3) 15.9	54, 54
412	31 x 92	610	Glass Fiber (G1)	92	Type X	12.7	55
416	31 x 92	610	Glass Fiber (G1)	92	Regular	12.7	53
369	31 x 92	610	Glass Fiber (G1)	92	Type X	15.9	58
398	31 x 92	610	Mineral Fiber (M2)	40	Type X	15.9	55
028	31 x 92	610	Cellulose (C2)	92	Type X	12.7	56
387	31 x 92	610	Cellulose (C2)	92	Type X	15.9	51

Notes:

Reference report IRC-IR-761

Metric conversion: 1 in. = 25.4 mm

- 2 layers gypsum board
- Steel studs (0.46 mm, 0.018 in. thick)
- Insulation
- 3 layers gypsum board

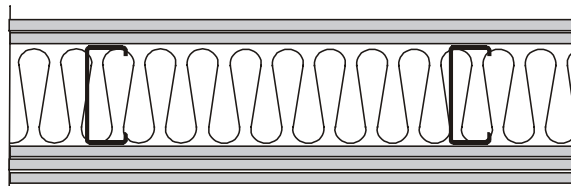

**Table B8 – Non-Load Bearing Walls – STC Rating**

Test No.	Stud Size mm	Stud Spacing Mm	Insulation		Gypsum Board		STC Rating
			Type	Thickness (mm)	Type	Thickness (mm)	
<b>31 x 92 mm Non-load bearing Studs</b>							
371	31 x 92	610	None	-	(3) Type X (1) Regular	15.7/12.7	54

Notes:

Reference report IRC-IR-761

Metric conversion: 1 in. = 25.4 mm

- 1 layer gypsum board
  - Steel studs and insulation
  - Gap
  - Steel studs and insulation
  - 1 layer gypsum board
- (Studs 0.46 mm, 0.018 in. thick)

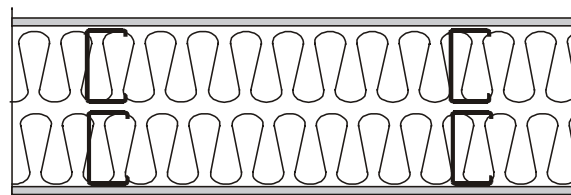

**Table B9 – Non-Load Bearing Walls – STC Rating**

Test No.	Stud Size (mm)	Stud Spacing (mm)	Insulation		Gypsum Board		STC Rating
			Type	Thickness (mm)	Type	Thickness (mm)	
<b>31 x 40 mm Non-load bearing Studs</b>							
306	31 x 40	610	Mineral Fiber (M2)	40	Type X	12.7	53
309, 310	31 x 40	610	Mineral Fiber (M2)	40	Type X	15.9	54, 55
<b>31 x 64 mm Non-load bearing Studs</b>							
303	31 x 64	610	Glass Fiber (G1)	64	Type X	12.7	54
300	31 x 64	610	Glass Fiber (G1)	64	Type X	15.9	55

Notes:

Reference report IRC-IR-761

Metric conversion: 1 in. = 25.4 mm

- 1 layer gypsum board
  - Steel studs and insulation
  - Gap
  - Steel Studs and insulation
  - 2 layers gypsum board
- (Studs 0.46 mm, 0.018 in. thick)

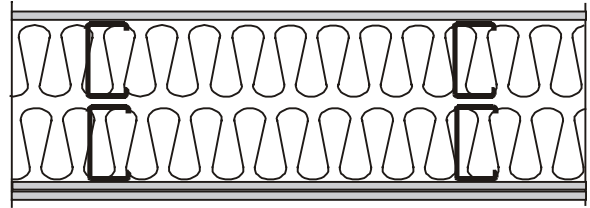

**Table B10 – Non-Load Bearing Walls – STC Rating**

Test No.	Stud Size (mm)	Stud Spacing (mm)	Insulation		Gypsum Board		STC Rating
			Type	Thickness (mm)	Type	Thickness (mm)	
<b>31 x 40 mm Non-load bearing Studs</b>							
307	31 x 40	610	Mineral Fiber (M2)	40	Type X	12.7	59
<b>31 x 64 mm Non-load bearing Studs</b>							
304	31 x 64	610	Glass Fiber (G1)	64	Type X	12.7	60
301	31 x 64	610	Glass Fiber (G1)	64	Type X	15.9	61

Notes:

Reference report IRC-IR-761

Metric conversion: 1 in. = 25.4 mm

- 2 layers gypsum board
  - Steel studs and insulation
  - Gap
  - Stud and insulation
  - 2 layers gypsum board
- (Studs 0.46 mm, 0.018 in. thick)

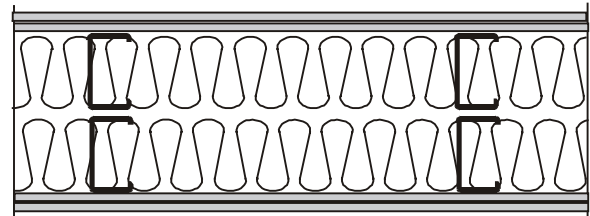

**Table B11 – Non-Load Bearing Walls – STC Rating**

Test No.	Stud Size (mm)	Stud Spacing (mm)	Insulation		Gypsum Board		STC Rating
			Type	Thickness (mm)	Type	Thickness (mm)	
<b>31 x 40 mm Non-load bearing Studs</b>							
308	31 x 40	610	Mineral Fiber (M2)	40	Type X	12.7	63
320, 321	31 x 40	610	Mineral Fiber (M2)	40	Type X	15.9	65, 65
<b>31 x 64 mm Non-load bearing Studs</b>							
305	31 x 64	610	Glass Fiber (G1)	64	Type X	12.7	62
302	31 x 64	610	Glass Fiber (G1)	64	Type X	15.9	64

Notes:

Reference report IRC-IR-761

Metric conversion: 1 in. = 25.4 mm

- 2 layers gypsum board
- Steel studs
- Insulation
- Resilient channels
- 2 layers gypsum board

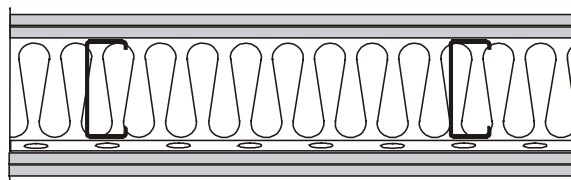

**Table B12 – Load Bearing Walls – Fire-Rating**

Test No.	Stud		R.C. spacing (mm)	Insulation		Gypsum Board		Fire Endurance (min.)
	Thickness (mm)	Spacing (mm)		Type	Thickness (mm)	Type	Thickness (mm)	
<b>41 x 92 mm Load bearing Studs</b>								
F37	0.91	406	406	None	-	Type X	12.7	77
F39	0.91	406	None	None	-	Type X	12.7	83
F27	0.91	406	406	Glass Fiber	89	Type X	12.7	56
F35, F36	0.84	406	406	Glass Fiber	89	Type X	12.7	68, 63
F38	0.91	406	406	Mineral Fiber	90	Type X	12.7	59
F28	0.91	610	406	Mineral Fiber	90	Type X	12.7	74
F31	0.91	406	406	Cellulose	90	Type X	12.7	71

Notes:

Tests are from reference report IRC-IR-833

Metric conversion: 1 in. = 25.4 mm

- 2 layers gypsum board
- Steel studs
- Insulation
- 12.7 mm OSB Shear Panel (fire side)
- 1 layer gypsum board

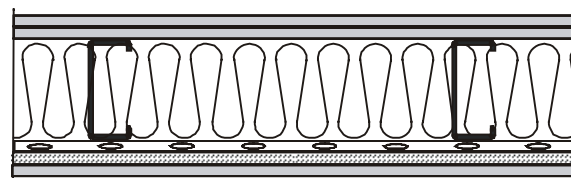

**Table B13 – Load Bearing Walls – Fire-Rating**

Test No.	Stud		R.C. spacing (mm)	Insulation		Gypsum Board		Fire Endurance (min.)
	Thickness (mm)	Spacing (mm)		Type	Thickness (mm)	Type	Thickness (mm)	
<b>41 x 92 mm Load bearing Studs</b>								
F29	0.91	406	406	Glass Fiber	89	Type X	12.7	33

Notes:

Tests are from reference report IRC-IR-833.

Metric conversion: 1 in. = 25.4 mm

- 2 layers gypsum board
- Steel studs and insulation
- Gap
- Steel studs and insulation
- 2 layers gypsum board

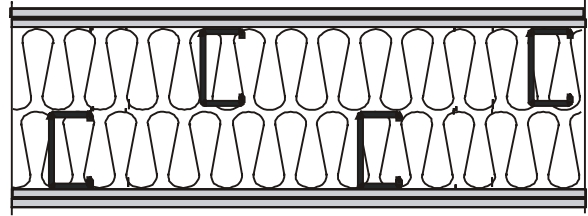

**Table B14 – Load Bearing Walls – Fire-Rating**

Test No.	Stud		R.C. spacing (mm)	Insulation		Gypsum Board		Fire Endurance (min.)
	Thickness (mm)	Spacing (mm)		Type	Thickness (mm)	Type	Thickness (mm)	
<b>41 x 92 mm Load bearing Studs</b>								
F30, F30R	0.91	406	406	None	-	Type X	12.7	100, 102
F26	0.91	406	406	Mineral Fiber	90	Type X	12.7	84

Notes:

Tests are from reference report IRC-IR-833.

Metric conversion: 1 in. = 25.4 mm

- 1 layer gypsum board
- Steel studs
- Insulation
- Resilient channels (R.C.)
- 1 layer gypsum board

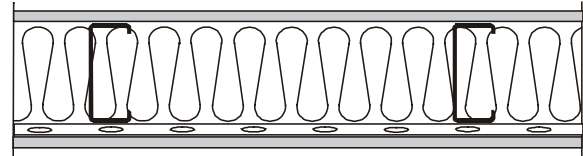

**Table B15 – Load Bearing Walls – STC Rating**

Test No.	Stud		R.C. spacing (mm)	Insulation		Gypsum Board		STC Rating
	Thickness (mm)	Spacing (mm)		Type	Thickness (mm)	Type	Thickness (mm)	
<b>31 x 92 mm Load bearing Studs</b>								
TLA-105	0.91	406	406	Glass Fiber (G1)	89	Type X	12.7	45
TL-022 TLA-095	0.91	406	610	Glass Fiber (G1)	92	Type X	12.7	48 47
TL-025 TLA-089	0.91	406	610	Glass Fiber (G1)	92	Type X	15.9	49 49
TL-354	1.22	406	610	Glass Fiber (G1)	92	Type X	15.9	50
TL-355	1.52	406	610	Glass Fiber (G1)	92	Type X	15.9	49
<b>31 x 152 mm Load bearing Studs</b>								
TL-353	1.22	406	610	Glass Fiber (G1)	92	Type X	15.9	50

Notes:

“TL” tests are from reference report IRC-IR-761. “TLA” tests are from reference report IRC-IR-832.

Metric conversion: 1 in. = 25.4 mm



- 2 layers gypsum board
- Steel studs
- Insulation
- Resilient channels (R.C.)
- 1 layer gypsum board

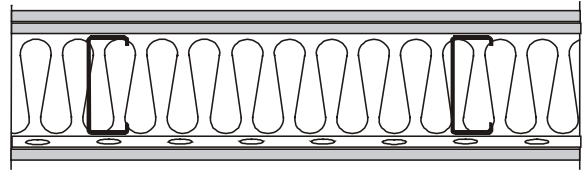

**Table B16 – Load Bearing Walls– STC Rating**

Test No.	Stud		R.C. spacing (mm)	Insulation		Gypsum Board		STC Rating
	Thickness (mm)	Spacing (mm)		Type	Thickness (mm)	Type	Thickness (mm)	
<b>31 x 92 mm Load bearing Studs</b>								
019	0.91	406	610	Glass Fiber (G1)	92	Type X	12.7	54
016	1.52	406	610	Glass Fiber (G1)	92	Type X	12.7	53
023	0.91	406	610	Mineral Fiber (M1)	92	Type X	12.7	54
013	1.52	406	610	Mineral Fiber (M1)	92	Type X	12.7	53

Notes:

Reference report IRC-IR-761

Metric conversion: 1 in. = 25.4 mm

- 1 layer gypsum board
- Steel studs
- Insulation
- Resilient channels (R.C.)
- 2 layers gypsum board

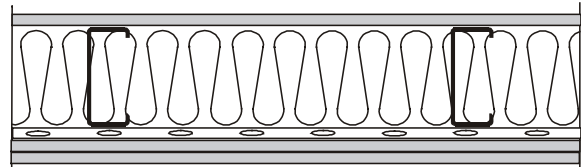

**Table B17 – Load Bearing Walls– STC Rating**

Test No.	Stud		R.C. spacing (mm)	Insulation		Gypsum Board		STC Rating
	Thickness (mm)	Spacing (mm)		Type	Thickness (mm)	Type	Thickness (mm)	
<b>31 x 92 mm Load bearing Studs</b>								
021	0.91	406	610	Glass Fiber (G1)	92	Type X	12.7	54
018	1.52	406	610	Glass Fiber (G1)	92	Type X	12.7	53

Notes:

Reference report IRC-IR-761

Metric conversion: 1 in. = 25.4 mm

- 2 layers gypsum board
- Steel studs
- Insulation
- Resilient channels (R.C.)
- 2 layers gypsum board

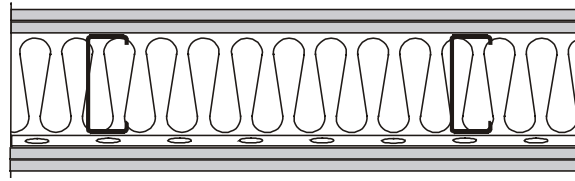

**Table B18 – Load Bearing Walls– STC Rating**

Test No.	Stud		R.C. spacing (mm)	Insulation		Gypsum Board		STC Rating
	Thickness (mm)	Spacing (mm)		Type	Thickness (mm)	Type	Thickness (mm)	
<b>31 x 92 mm Load bearing Studs</b>								
TLA-065	0.91	406	406	Glass Fiber	89	Type X	12.7	57
TLA-079	1.52	406	406	Glass Fiber	89	Type X	12.7	57
TLA-081	1.52	406	406	Mineral Fiber	90	Type X	12.7	56
TLA-071	0.91	406	406	Glass Fiber	89	Type X	15.9	58
TLA-081	1.52	406	406	Glass Fiber	89	Type X	15.9	57
TLA-063	0.91	406	610	None	-	Type X	12.7	50
TL-020 TLA-099	0.91	406	610	Glass Fiber (G1)	90	Type X	12.7	60 59
TL-017	1.52	406	610	Glass Fiber (G1)	90	Type X	12.7	59
TL-024	0.91	406	610	Mineral Fiber (M1)	90	Type X	12.7	60
TL-014	1.52	406	610	Mineral Fiber (M1)	90	Type X	12.7	59
TLA-075	0.91	406	610	None	-	Type X	15.9	51
TLA-073 TLA-093	0.91	406	610	Glass Fiber	89	Type X	15.9	59 59

Notes:

“TL” tests are from reference report IRC-IR-761.

“TLA” tests are from reference report IRC-IR-832.

Metric conversion: 1 in. = 25.4 mm

- 1 layer gypsum board
- 65 mm non-load bearing steel studs and insulation
- Gap
- 1 layer gypsum board
- 92 mm load bearing steel studs and insulation
- 1 layer gypsum board

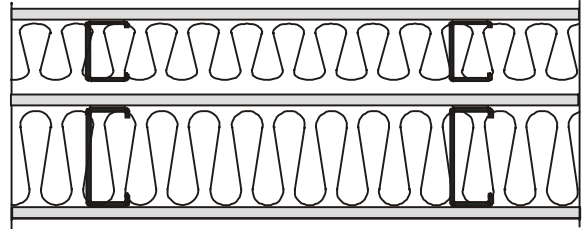
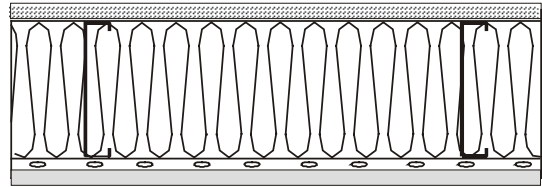

**Table B19 – Load Bearing Walls– STC Rating**

Test No.	Stud		R.C. spacing (mm)	Insulation		Gypsum Board		STC Rating
	Thickness (mm)	Spacing (mm)		Type	Thickness (mm)	Type	Thickness (mm)	
<b>31 x 92 mm Load bearing Studs</b>								
TLA-077	0.46, 0.91	406	-	Glass Fiber	89	Type X	15.9	48

Notes:  
 “TLA” tests are from reference report IRC-IR-832.  
 Metric conversion: 1 in. = 25.4 mm

- 1 layer sub-floor sheathing
- Steel floor joists
- Insulation
- Resilient channels at 406 mm o.c.
- 1 layer 12.7 mm Type X gypsum board

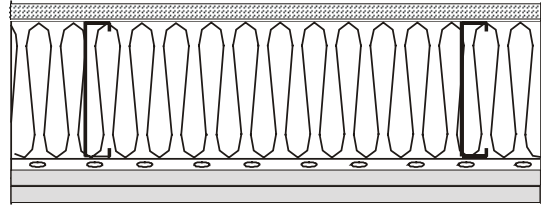

**Table B20 – Floors – Fire-Rating**

Test No.	Joist			Sub-floor		Insulation		Fire Endurance (min.)
	Thickness (mm)	Depth (mm)	Spacing (mm)	Type	Thickness (mm)	Type	Thickness (mm)	
FF-25	1.22	203	406	Plywood	15.9	Rock fiber	90	46

Notes:  
 Reference report IRC-IR-764  
 Metric conversion: 1 in. = 25.4 mm

- 1 layer sub-floor sheathing
- Steel floor joists
- Insulation
- Resilient channels at 406 mm o.c.
- 2 layers 12.7 mm Type X gypsum board



**Table B21 – Floors – Fire-Rating**

Test No.	Joist			Sub-floor		Insulation		Fire Endurance (min.)
	Thickness (mm)	Depth (mm)	Spacing (mm)	Type	Thickness (mm)	Type	Thickness (mm)	
FF-22	1.22	203	406	Plywood	15.9	None	-	74
FF-23	1.22	203	406	Plywood	15.9	Glass fiber	90	68
FF-24	1.22	203	610	Plywood	15.9	Glass fiber	90	69

Notes:

Reference report IRC-IR-764

Metric conversion: 1 in. = 25.4 mm

- 38 mm concrete
- 1 layer sub-floor sheathing
- Steel floor joists
- Insulation
- Resilient channels at 406 mm o.c.
- 2 layers 12.7 mm Type X gypsum board

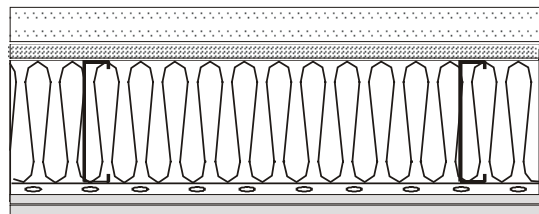

**Table B22 – Floors – Fire-Rating**

Test No.	Joist			Sub-floor		Insulation		Fire Endurance (min.)
	Thickness (mm)	Depth (mm)	Spacing (mm)	Type	Thickness (mm)	Type	Thickness (mm)	
FF-27	1.22	203	406	Plywood	15.9	Glass fiber	90	60

Notes:

Reference report IRC-IR-764

Metric conversion: 1 in. = 25.4 mm

- 1 layer OSB
- Steel floor joists
- Insulation
- Resilient channels at 610 mm o.c.
- 1 layer 15.9 mm Type X gypsum board

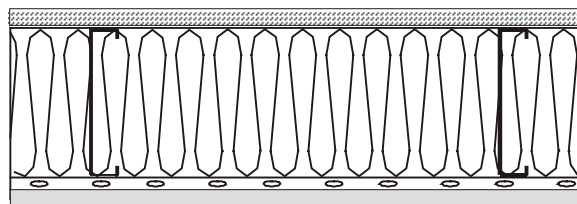

**Table B23 – Floors – STC Rating**

Test No.	Joist			Sub-floor		Insulation		IIC Rating	STC Rating
	Thickness (mm)	Depth (mm)	Spacing (mm)	Type	Thickness (mm)	Type	Thickness (mm)		
TLF-057/028	1.91	203	406	OSB	15.1	Glass fiber	152	45	52
TLF-059/029	1.52	203	406	OSB	15.1	Glass fiber	152	45	51
TLF-061/030	1.22	203	406	OSB	15.1	Glass fiber	152	44	50
TLF-063/031	1.52	203	610	OSB	15.1	Glass fiber	152	44	53
TLF-065/032	1.52	254	406	OSB	15.1	Glass fiber	152	44	51
TLF-069/034	1.52	305	406	OSB	15.1	Glass fiber	152	44	52
TLF-067/033	1.52	203	610	OSB	15.1	Glass fiber	152	44	53
TLF-009/004	1.52	203	406	OSB	15.1	None	-	35	44
TLF-001a/001	1.52	203	406	OSB	15.1	Glass fiber	152	43	50
TLF-005/002	1.52	203	406	OSB	15.1	Mineral fiber	140	45	51
TLF-011/005	1.52	203	406	OSB	15.1	Cellulose	90	44	51
TLF-011/005	1.52	203	406	OSB	15.1	Cellulose	140	45	52

Notes:

Reference report IRC-IR-766

Metric conversion: 1 in. = 25.4 mm

- 25 mm gypsum concrete
- 1 layer OSB
- Steel floor joists
- Insulation
- Resilient channels at 610 mm o.c.
- 1 layer 15.9 mm Type X gypsum board

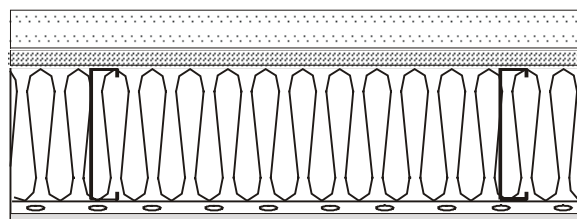

**Table B24 – Floors – STC and IIC Rating**

Test No.	Joist			Sub-floor		Insulation		IIC Rating	STC Rating
	Thickness (mm)	Depth (mm)	Spacing (mm)	Type	Thickness (mm)	Type	Thickness (mm)		
TLF-079/039	1.52	203	406	OSB	15.1	None	-	24	55
TLF-081/040	1.52	203	406	OSB	15.1	Glass fiber	152	28	60

Notes:

Reference report IRC-IR-766

Metric conversion: 1 in. = 25.4 mm



**APPENDIX C**  
**METRIC CONVERSION FACTORS**





## Residential Steel Framing – Fire and Acoustic Details

The following list provides the conversion relationship between U.S. customary units and the International System (SI) units. A complete guide to the SI system and its use can be found in ASTM E 380, Metric Practice.

To convert from	To	Multiply by	To convert from	To	Multiply by
<b>Length</b>			<b>Stress or pressure</b>		
Inch (in.)	Micrometer (µm)	25,400	Pound/sq. foot (psf)	Kilogram/square meter (kg/sq. m)	4.8824
Inch (in.)	Millimeter (mm)	25.4	Pound/sq. foot (psf)	Pascal (Pa)	47.88
Inch (in.)	Centimeter (cm)	2.54	<b>Mass (weight)</b>		
Inch (in.)	Meter (m)	0.0254	Pound (lb.)	Kilogram (kg)	0.4535924
Foot (ft)	Meter (m)	0.3048	Ton, 2000 lb	Kilogram (kg)	907.1848
Yard (yd)	Meter (m)	0.9144	Grain	Kilogram (kg)	0.0000648
Mile (mi)	Kilometer (km)	1.6	<b>Mass (weight) per length</b>		
<b>Area</b>			Kip per linear foot (klf)	Kilogram per meter (kg/m)	0.001488
Square foot (sq. ft)	Square meter (sq. m)	0.0929	Pound per linear foot (plf)	Kilogram per meter (kg/m)	1.488
Square inch (sq. in.)	Square centimeter (sq. cm)	6.452	<b>Moment</b>		
Square inch (sq. in.)	Square meter (sq. m)	0.00064516	1 foot-pound (ft-lb.)	Newton-meter (N-m)	1.356
Square yard (sq. yd)	Square meter (sq. m)	0.8391	<b>Mass per volume (density)</b>		
Square mile (sq. mi)	Square kilometer (sq. km)	2.6	Pound per cubic foot (pcf)	Kilogram per cubic meter (kg/cu m)	16.01846
<b>Volume</b>			Pound per cubic yard (lb/cu yd)	Kilogram per cubic meter (kg/cu m)	0.5933
Cubic inch (cu in.)	Cubic centimeter (cu cm)	16.387064	<b>Velocity</b>		
Cubic inch (cu in.)	Cubic meter (cu m)	0.00001639	Mile per hour (mph)	Kilometer per hour (km/hr)	1.60934
Cubic foot (cu ft)	Cubic meter (cu m)	0.02831685	Mile per hour (mph)	Kilometer per second (km/sec)	0.44704
Cubic yard (cu yd)	Cubic meter (cu m)	0.7645549	<b>Temperature</b>		
Gallon (gal) Can. liquid	Liter	4.546	Degree Fahrenheit (°F)	Degree Celsius (°C)	$t_C = (t_F - 32)/1.8$
Gallon (gal) Can. liquid	Cubic meter (cu m)	0.004546	Degree Fahrenheit (°F)	Degree Kelvin (°K)	$t_K = (t_F + 59.7)/1.8$
Gallon (gal) U.S. liquid*	Liter	3.7854118	Degree Kelvin (°K)	Degree Celsius (°C)	$t_C = (t_K - 273.15)$
Gallon (gal) U.S. liquid	Cubic meter (cu m)	0.00378541	Degree Celsius (°C)	Degree Fahrenheit (°F)	$t_F = 1.8t_C + 32$
Fluid ounce (fl oz)	Milliliters (ml)	29.57353	* One U.S. gallon equals 0.8327 Canadian gallon		
Fluid ounce (fl oz)	Cubic meter (cu m)	0.00002957	** A Pascal equals 1000 Newton per square meter.		
<b>Force</b>			The prefixes and symbols below are commonly used to form names and symbols of the decimal multiples and submultiples of the SI units		
Kip (1000 lb.)	Kilogram (kg)	453.6	<b>Multiplication Factor</b>	<b>Prefix</b>	<b>Symbol</b>
Kip (1000 lb.)	Newton (N)	4,448.222	1,000,000,000 = 10 <sup>9</sup>	Giga	G
Pound (lb.)	Kilogram (kg)	0.4535924	1,000,000 = 10 <sup>6</sup>	Mega	M
Pound (lb.)	Newton (N)	4.448222	1,000 = 10 <sup>3</sup>	Kilo	k
<b>Stress or pressure</b>			0.01 = 10 <sup>-2</sup>	Centi	c
Kip/sq. inch (ksi)	Mega Pascal (Mpa)	6.894757	0.001 = 10 <sup>-3</sup>	Milli	m
Kip/sq. inch (ksi)	Kilogram/square centimeter (kg/sq. cm)	70.31	0.000001 = 10 <sup>-6</sup>	Micro	µ
Pound/sq. inch (psi)	Kilogram/square centimeter (kg/sq. cm)	0.07031	0.000000001 = 10 <sup>-9</sup>	Nano	n
Pound/sq. inch (psi)	Pascal (Pa) **	6,894.757			
Pound/sq. inch (psi)	Mega Pascal (Mpa)	0.00689476			

