

**Guide for the  
Implementation of  
PL 102-522 for  
Fire Alarm and  
Automatic Sprinkler  
Installations**

# **Guide for the Implementation of PL 102-522 for Fire Alarm and Automatic Sprinkler Installations**

Prepared for:  
U.S. Department of Housing and Urban Development  
Office of Policy Development and Research

Prepared by:  
National Institute of Standards and Technology  
Gaithersburg, MD

September 1995

## **Notice**

The U.S. Government does not endorse products or manufacturers. Trade or manufacturers' names appear herein solely because they are considered essential to the object of this report.

The contents of this report are the views of the contractor and do not necessarily reflect the views or policies of the U.S. Department of Housing and Urban Development or the U.S. Government.

## Foreword

The 1992 Fire Administration Authorization Act (PL 102-522) included three provisions that directly affect HUD-assisted housing: (1) newly constructed, four-story or higher multifamily buildings must be protected with an automatic sprinkler system and hard-wired smoke detectors; (2) rebuilt, four-story or higher multifamily buildings must be brought into compliance with Chapter 19 of National Fire Protection Association 101, the “Life Safety Code;” and (3) other dwelling units must be protected by hard-wired or battery-operated smoke detectors installed in compliance with NFPA 74, “Standard for the Installation, Maintenance, and Use of Household Fire Warning Equipment.”

The National Institute of Standards and Technology (NIST) has developed this *Guide for the Implementation of PL 102-522 for Fire Alarm and Automatic Sprinkler Installations* to assist HUD field offices in the efficient implementation of the provisions in the Act. The guide provides information on installation of smoke detectors and automatic sprinkler systems. It does not address the rebuilt multifamily properties that must be brought into compliance with the “Life Safety Code.”

I hope that this guide will prove useful to HUD field offices and to property owners and contractors involved with HUD-assisted housing.

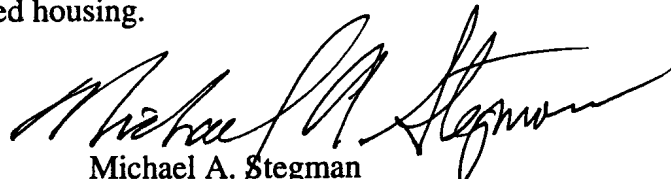

Michael A. Stegman  
Assistant Secretary for Policy  
Development and Research

## Acknowledgments

This guide was developed by HUD to assist field personnel in the efficient implementation of the requirements of the Fire Administration Authorization Act of 1992 (PL 102-522). The material in this guide was developed by Mr. Richard W. Bukowski, P.E. and Mr. Edward K. Budnick, P.E., both internationally recognized experts in the field. Mr. Bukowski is a Senior Research Engineer with the National Institute of Standards and Technology's Building and Fire Research Laboratory in Gaithersburg, Maryland. He is a 20 year veteran of the National Fire Protection Association's (NFPA) National Fire Alarm Code Committee (NFPA 72), and chairs the committee responsible for Chapter 2 (formerly NFPA 74). He has published extensively on the subject of fire detection and alarm systems and is an author of *Fire Alarm Signaling Systems*, the popular text on the subject published by the NFPA and Society of Fire Protection Engineers.

Mr. Budnick is Vice President and Senior Engineer of Hughes Associates, Inc., a fire protection engineering, research, and development firm in Columbia, Maryland. He has been a member of the NFPA Committee on Automatic Sprinklers since 1983, and serves on the task groups for NFPA 13D, NFPA 13R, and New Technology. He chairs the NFPA Research Foundation's Technical Advisory Committee for quick response, early suppression automatic sprinklers and has authored numerous publications on the performance of sprinklers, including "Sprinklers and Other Fire Control Methods" in the *Encyclopedia of Architectural Design, Engineering, and Construction*, published by John Wiley & Sons.

## Contents

	Page
Part I. General/Guidelines .....	I-1
I.1 Using This Guide .....	I-1
I.2 Quick Reference/Implementation .....	I-2
Identifying the Appropriate HUD Property Category .....	I-3
Determining the Required Protection .....	I-4
Identifying the Applicable Codes and Standards .....	I-5
Steps in the Design/Install Process .....	I-5
Choosing the Contractor(s) .....	I-6
Important Design Factors .....	I-6
Part II. Basic Requirements .....	II-1
II.1 Legal Basis .....	II-1
Newly Constructed Multifamily Housing Projects .....	II-1
Rebuilt Multifamily Housing Properties .....	II-2
Other Dwelling Units .....	II-2
II.2 Property Categories and Required Protection Levels .....	II-2
Newly Constructed Multifamily Projects .....	II-2
Rebuilt Multifamily Housing Properties .....	II-2
Other Dwelling Units .....	II-3
State and Local Requirements .....	II-3
II.3 Minimum Requirements for Installed Alarm and Sprinkler Systems .....	II-3
II.3.1 Newly Constructed Multifamily Housing Properties .....	II-3
II.3.2 Rebuilt Multifamily Housing Properties .....	II-11
II.3.3 Other Dwelling Units .....	II-14
II.4 Additional Considerations .....	II-15
II.4.1 Fire Alarm Systems .....	II-15
II.4.2 Automatic Sprinkler Systems .....	II-18
Part III. Important Issues in Implementing Sprinkler Requirements .....	III-1
III.1 Understanding Sprinkler Technology .....	III-1
III.2 Steps in the Design/Install Process .....	III-3
III.3 Choosing the Right Sprinkler Design Standard .....	III-4
III.3.1 HUD Property Categories .....	III-4
III.3.2 Required Levels of Sprinkler Protection and Governing Standards .....	III-5
III.4 Selecting the Contractor(s) .....	III-6
III.5 Important Differences in Minimum Sprinkler Requirements .....	III-7
III.5.1 NFPA 13, Installation of Sprinkler Systems (1994 ed) .....	III-7
III.5.2 NFPA 13R, Sprinkler Systems in Residential Occupancies Up to and Including Four Stories in Height (1994 ed) .....	III-10
III.5.3 NFPA 101, Life Safety Code, Chapter 19 (1994 ed) .....	III-13
III.6 Demonstrating an Equivalent Level of Safety to Sprinklers .....	III-18
Part IV. References .....	IV-1
Appendix A. Sample Forms/Checklists .....	A-1
Appendix B. Equivalent Level of Safety Analysis .....	B-1
Appendix C. Available Resources .....	C-1

## List of Tables and Figures

### Tables

Table I.1	HUD Property Categories	I-3
Table I.2	Required Levels of Alarm and Sprinkler Protection	I-4
Table I.3	Governing Codes and Standards for HUD Property Categories	I-5
Table I.4	Steps in the Design/Install Process	I-5
Table I.5	Design/Installation Guidelines	I-6
Table I.6	Important Design Factors for Fire Alarm and Automatic Sprinkler Installations	I-7
Table III.1	Required Automatic Sprinkler Protection Governing Codes/Standards	III-6
Table III.2	Summary of Minimum Requirements for Automatic Sprinklers	III-16

### Figures

Figure II.1(a)	Typical household multiple-station smoke detector system	II-4
Figure II.1(b)	Typical household fire alarm system with separate control panel	II-4
Figure II.2(a)	A smoke detector should be located between each sleeping area and the rest of the family living unit	II-5
Figure II.2(b)	In family living units with more than one sleeping area, a smoke detector (indicated by a +) should be provided to protect each separate sleeping area. In new construction, additional smoke detectors are required within each bedroom unless protected by automatic sprinklers (indicated by *).	II-5
Figure II.3(a)	As a minimum, a smoke detector should be located on each story	II-6
Figure II.3(b)	Required smoke detectors in a split-level arrangement. (The indicated smoke detector is optional if no door is provided between split-level living and recreation rooms.)	II-6
Figure II.4(a)	Typical “pendent” sprinkler layout for apartments (bathrooms not exempted)	II-8
Figure II.4(b)	Typical “sidewall” sprinkler layout for apartments (bathrooms meet the exemption.)	II-9
Figure II.5	Examples of the four-sprinkler design area for dwelling units in conformance with NFPA 13.	II-11
Figure II.6	Preferable arrangement	II-20
Figure II.7	Examples of proper thermal insulation in attics containing sprinkler piping	II-22

# Guide for the Implementation of PL 102-522 for Fire Alarm and Automatic Sprinkler Installations

## Part I. General/Guidelines

### *I.1 Using This Guide*

This guide provides both general and detailed information for Housing and Urban Development (HUD) field personnel regarding implementation of Public Law 102-522 pertaining to installation of fire alarm and automatic sprinkler systems. The guide is divided into several parts, including the following:

Part I.	General Guidelines;
Part II.	Basic Requirements; and
Part III.	Important Issues in Implementing Sprinkler Requirements.

Part III is exclusively dedicated to automatic sprinklers. This separate treatment of sprinklers is necessary due to the variations in requirements among the applicable codes and standards. In Part III, similarities and differences in requirements for key design features are summarized in order to assist HUD field personnel in achieving cost-effective installations.

There are several important features in this guide that are designed to simplify the implementation of the public law or its use, and provide important guidance regarding cost effectiveness, system reliability, and opportunities for significant improvements in life safety. In Part II.4, Additional Considerations, information and recommendations are provided which go beyond the minimum requirements for alarm and sprinkler system design/installation but which require consideration in order to insure reliable performance.

In addition, “advisories” are used throughout the document to clarify minimum requirements or provide design guidance that can help field office personnel when implementing the requirements of PL 102-522.

A shorthand implementation guide is provided here in Part I.2, Quick Reference/Implementation. The details associated with the various steps in achieving compliance with PL 102-522 are included in the other parts of the guide. The quick reference can be used to categorize candidate properties, identify basic alarm and sprinkler requirements, and for review of general topics/issues such as the following:

- \* Applicable Codes and Standards,
- \* Steps in the Design/Install Process,
- \* Important Design Factors, and
- \* Contractor Qualifications.



Finally, Appendix A provides sample “statements of work” and forms/schedules for approval testing and maintenance; Appendix B provides a list of selected references and organizations that can provide valuable information to HUD field office personnel regarding alarm and sprinkler technologies and consumer guidance.

## ***1.2 Quick Reference/Implementation***

This section provides a summary of the requirements and related information that is detailed throughout the other parts of the guide. The information is summarized in tables for quick reference regarding general questions such as the following:

- \* Which HUD property category applies to a particular property?;
- \* What are the basic levels of fire alarm and sprinkler system protection required for a particular property?;
- \* Which code(s) and/or standards are applicable?;
- \* What are the generic steps in the design/install process?;
- \* What are the required qualifications of potential designers or installers?; and
- \* What general design considerations have the greatest impact on cost and performance?

**Identifying the Appropriate HUD Property Category:** Table I.1 can be used to identify the appropriate HUD property category for a particular property under consideration.

Table I.1 HUD Property Categories

HUD Property Category	Elements
<p>I. Newly Constructed Multifamily</p>	<p>(a) ≥ 4 stories, and            (b) ≥ 5 units under one roof, and            (c) constructed after 10/26/92, and            (d) HUD assistance used or committed after 10/26/92            Exempted: New properties which received HUD binding commitments for assistance before 10/26/92</p>
<p>II. Rebuilt Multifamily</p>	<p>(a) ≥ 4 stories, and            (b) ≥ 5 units under one roof, and            (c) rebuilt on or after 10/1/94, and            (d) HUD assistance or binder before construction began, and            (e) cost of alteration ≥ 70 % of replacement cost</p>
<p>III. Other Dwelling Units</p>	<p>(a) all other properties ≥ 4 stories, or            (b) multifamily from 1-3 stories, or            (c) single family</p>

**Determining the Required Protection:** Once the property category has been determined, the following table can be used to identify the minimum level of alarm and sprinkler protection required.

Table I.2 Required Levels of Alarm and Sprinkler Protection

HUD Property Category	Required Protection	
	Detection/Alarm	Automatic Sprinklers
<b>I. Newly Constructed Multifamily</b>		
4 stories	<ul style="list-style-type: none"> <li>• smoke detectors in dwelling units</li> <li>• alarm/pull boxes throughout building*</li> <li>• sprinkler water flow connected to alarm system</li> </ul>	Complete coverage**
>4 stories	(same as for 4 stories)	Complete coverage**
<b>II. Rebuilt Multifamily</b>		
Option 1 (NFPA 101, Ch 19)	None	None
Option 2 (NFPA 101, Ch 19)	(same as for Newly Constructed) and complete smoke detector coverage	None
Option 3 (NFPA 101, Ch 19) 4 stories 5 or 6 stories	(same as for Newly Constructed)* (same as for Newly Constructed)*	Partial coverage Partial coverage
Option 4 (NFPA 101, Ch 19) >6 stories	(same as for Newly Constructed)*	Complete coverage
<b>III. Other Dwelling Units</b>		
Newly Constructed	<ul style="list-style-type: none"> <li>• single/multiple station smoke detectors</li> <li>• outside all sleeping areas</li> <li>• on each “level”</li> <li>• within each sleeping room</li> <li>• hard-wired and interconnected</li> </ul>	None
Existing	<ul style="list-style-type: none"> <li>• single/multiple station smoke detectors</li> <li>• outside sleeping areas</li> <li>• on each level</li> <li>• battery or hard-wired</li> <li>• clearly audible or interconnected</li> </ul>	None

\* Requirements vary depending on fire resistance and egress features.

\*\* For buildings in New York City, the automatic sprinklers may be omitted if an engineering analysis demonstrates that an alternative design or system (which may include sprinklers) achieves a level of life safety of the building occupants, equal to or greater than that provided by the sprinklers. The required engineering analysis must be performed in accordance with guidelines established by the General Services Administration which are included in this Guide in Appendix B.

**Identifying the Applicable Codes and Standards:** The applicable codes and standards are set forth in Table I.3, depending on the HUD property category, the general building features (e.g., stories, number of units), and the scope of applicability of the individual codes or standards.

Table I.3 Governing Codes and Standards for HUD Property Categories

HUD Property Category	Governing Codes/Standards	
	Detection/Alarm	Automatic Sprinklers
<b>I. Newly Constructed Multifamily</b>		
4 stories	NFPA 72	NFPA 13 or 13R
>4 stories	NFPA 72, Ch 2 or NFPA 74 inside dwelling units	NFPA 13
<b>II. Rebuilt Multifamily</b>		
Option 1	Not applicable	Not applicable
Option 2	NFPA 101* (NFPA 72)	Not applicable
Option 3 4 stories 5 or 6 stories	NFPA 101* (NFPA 72; NFPA 74 or 72, Ch 2 (dwellings)) NFPA 101* (NFPA 72; NFPA 74 or 72, Ch 2 (dwellings))	NFPA 101* (NFPA 13 or 13R) NFPA 101* (NFPA 13)
Option 4 >6 stories	NFPA 101* (NFPA 72; NFPA 74 or 72, Ch 2 (dwellings))	NFPA 101* (NFPA 13)
<b>III. Other Dwelling Units</b>	NFPA 72; NFPA 74 or 72, Ch 2 (dwellings)	NFPA 13R or 13D

\* NFPA 101 outlines the alarm and sprinkler coverage requirements; NFPA 72, 74, 13 or 13R provide detailed system design guidance.

**Steps in the Design/Install Process:** The generic steps in the design/install process are listed in Table I.4. Detailed descriptions of each step are provided in Parts III and IV.

Table I.4 Steps in the Design/Install Process

Step	Description
1	Identification of HUD Property Category
2	Perform Basic Design Task
3	Complete Detailed Working Plans/Installation
4	Perform Acceptance/Approval Testing
5	Provide Inspection/Maintenance Plan

**Choosing the Contractor(s):** Experienced engineers, architects and installation contractors provide the greatest likelihood that the final installation will be the most cost effective without compromising life safety requirements. Table I.5 provides a summary of the minimum qualifications associated with the design/installation process.

Table I.5 Design/Installation Qualifications

Task	Minimum Professional Qualifications	
	Detection/Alarm	Automatic Sprinklers
Basic Design	<ul style="list-style-type: none"> <li>Licensed fire protection engineer</li> <li>Certified architect</li> <li>Design/install contractor meeting local requirements</li> </ul>	<ul style="list-style-type: none"> <li>Licensed fire protection engineer</li> <li>Certified architect</li> <li>Design/install contractor meeting local requirements</li> </ul>
Working Plans	Approved installation contractor: NICET Level III	Approved installation contractor: NICET Level III (review by NICET Level IV or licensed fire protection engineer)
Installation	<ul style="list-style-type: none"> <li>Installation by NICET Level I; supervised by NICET Level II or higher</li> <li>Licensed electricians for single and multiple station smoke detectors</li> </ul>	<ul style="list-style-type: none"> <li>Approved installation contractor</li> <li>Qualified “fitters”/ apprentices ratio of 1:1</li> <li>Local jurisdiction requirements</li> </ul>
Acceptance/Approval Testing	Approved installation contractor	Approved installation contractor
Inspection/Maintenance	Approved installation contractor <u>or</u> building owner's qualified personnel	Approved installation contractor <u>or</u> building owner's qualified personnel

Every effort should be made to identify contractors that meet or exceed these qualifications. Inexperience can lead to unnecessary costs, reduced effectiveness, and lack of system acceptance by the local Authority Having Jurisdiction (AHJ).

A simplified “Statement of Work” is provided in Appendix A for use as a template for obtaining design/installation services. While the example should be suitable as a framework for most contract efforts, additional provisions often may be necessary due to building features or local requirements related to the building or its location.

**Important Design Factors:** Detection and alarm systems must be installed in accordance with the National Fire Alarm Code (NFPA 72), which includes the requirements for residential smoke detection formerly included in NFPA 74, and the Life Safety Code (NFPA 101). Specific design requirements depend on the HUD property category. Installations should reflect compliance with the appropriate standards and cost effectiveness.

Sprinkler systems must be installed in accordance with NFPA 13 Installation of Sprinkler

Systems, NFPA 13R Sprinkler Systems in Residential Occupancies Up To and Including Four Stories in Height, and/or the Life safety Code (NFPA 101), depending on the HUD property category and the physical features of the building (e.g., number of stories). Design latitudes can be significant depending on which standard is used. There are advantages associated with selection of NFPA 13R as the governing standard whenever possible. The general level of life safety protection is not compromised measurably, but numerous potential cost reductions may be taken advantage of in the final installation.

There are many factors associated with the design of an alarm or sprinkler system which may significantly affect cost. As long as the installation meets the minimum requirements of the least restrictive standard that is applicable to the property a level of life safety consistent with residential buildings will be achieved. HUD field office personnel should be aware of the factors that can influence both cost and performance of alarm or sprinkler system installations. Table I.6 provides a summary of selected factors to be considered when complying with the alarm and sprinkler system requirements in Public Law 102-522.

Table I.6 Important Design Factors for Fire Alarm and Automatic Sprinkler Installations

Key Factors	Applicable to	
	Detection/Alarm	Automatic Sprinklers
<b>General Factors</b> <ul style="list-style-type: none"> <li>• Contractor Qualifications</li> <li>• Partial/Total Building Coverage</li> <li>• Exempted Areas</li> <li>• Alarm/Electrical Supervision</li> <li>• Hardware “Listings” (e.g., UL)</li> <li>• Acceptance/Approval Testing</li> <li>• Maintenance/Periodic Testing</li> <li>• Occupant Information</li> </ul>	✓ ✓ ✓ ✓ ✓ ✓ ✓ ✓	✓ ✓ ✓ ✓ ✓ ✓ ✓
<b>Special Factors</b> <ul style="list-style-type: none"> <li>• Power Sources</li> <li>• Provisions for Hearing Impaired</li> <li>• Water Backflow Protection</li> <li>• Freeze Protection</li> <li>• Seismic Protection</li> <li>• Sprinkler Hardware Selection</li> <li>• Local Water Authority Requirements</li> </ul>	✓ ✓	✓ ✓ ✓ ✓ ✓

Parts II and III provide discussions of requirements associated with these design factors, depending on the individual code or standards that apply.

## Part II. Basic Requirements

### *II.1 Legal Basis*

On October 26, 1992, President Bush signed the Fire Administration Authorization Act of 1992 (PL 102-522). Section 106 of this law adds a new Section 31 to the Federal Fire Prevention and Control Act of 1974 and prohibits the use of housing assistance in connection with certain assisted and insured properties unless various fire protection and safety standards are met.

In this law, the term “housing assistance” is defined to mean Federal assistance “... used in connection with the provision of housing, and ... provided in the form of a grant, contract, loan, loan guarantee, cooperative agreement, interest subsidy, insurance or direct appropriation.” This definition encompasses the entire range of HUD’s assisted housing programs. Where eligible under these programs, the term “housing assistance,” as used in the law includes Section 8 rental assistance (tenant- and project-based), homebuyers assistance, and assistance for project operating costs.

The law established requirements for three categories of housing:

1. newly constructed multifamily properties of four or more stories;
2. rebuilt multifamily properties of four or more stories; and
3. all other dwelling units.

The statutory requirements that define these categories of housing are as follows:

**Newly Constructed Multifamily Housing Properties** means a four-story or higher multifamily residential building consisting of five or more residential units under one roof that is newly constructed after October 26, 1992, and for which housing assistance is used for construction, or a binding commitment is made, before construction begins, to provide housing assistance for the newly constructed property.

Multifamily properties of four or more stories that are newly constructed after October 26, 1992 and that received binding commitments for housing assistance before October 26, 1992 to either carry out new construction or to assist the newly constructed property are specifically exempted from the requirements of the law’s new construction provision. Such properties are covered under the Other Dwelling Units category listed below to the extent that they received housing assistance on or after April 24, 1993.

For purposes of determining whether a property is subject to the new construction provisions the field office must determine whether a property meets the definition of “newly constructed multifamily property” and whether a binding commitment for housing assistance has been or will be entered into on or after October 26, 1992. Under the new construction category, the term “binding commitment” is interpreted differently depending on the particular program. For newly constructed Section 8 project-based certificate projects, a “binding commitment” means execution of an Agreement to Enter Into Housing Assistance Payments Contract (Agreement). In the public and Indian housing programs, the term means execution

of the Annual Contributions Contract (ACC).

**Rebuilt Multifamily Housing Properties** means a four-story or higher multifamily residential building of five or more units under one roof that is rebuilt on or after October 1, 1994 and for which housing assistance is used for rebuilding the property or a binding commitment is made, before rebuilding begins, to provide housing assistance for the rebuilt property. “Rebuilt” is defined as the repairing or reconstructing of portions of a multifamily property where the cost of the alterations is 70 percent or more of the replacement cost of the completed multifamily property, not including the value of the land on which the multifamily property is located.

As with newly constructed properties, the term “binding agreement” is defined in the Section 8 project-based certificate and moderate rehabilitation programs to mean execution of an Agreement to Enter Into Housing Assistance Payments Contract (Agreement). In the public and Indian housing program, “binding commitment” means execution of the ACC.

**Other Dwelling Units** are not limited to federally-assisted multifamily residential properties in buildings of four or more stories, but also encompasses federally-assisted single-family residential units and multifamily units in buildings one to three stories in height. The category further covers all public and Indian housing, HOPE 1 assisted properties, and Section 8 certificate (both project and tenant-based), voucher, and moderate rehabilitation units that are not explicitly included under either the new construction or rebuilt definitions.

## ***II.2 Property Categories and Required Protection Levels***

**Newly Constructed Multifamily Properties** are required to be equipped during construction with automatic sprinkler systems and hard-wired smoke detectors. The automatic sprinkler systems must be in compliance with the National Fire Protection Association standards NFPA 13, 13D, or 13R (or successor standards) as appropriate and must include an alarm signaling system with appropriate warning signals in accordance with the National Fire Alarm Code, NFPA 72 (or successor standards) to the extent that such an alarm system is required by Federal, State, or local laws or regulations. In addition to the sprinkler system and associated alarms, the dwellings are required to be protected by hard-wired smoke detectors installed in accordance with NFPA 74 or its successor standard. Note that NFPA 74 has been superseded by Chapter 2 of the National Fire Alarm Code, NFPA 72.

For buildings in New York City, the automatic sprinklers may be omitted if an engineering analysis demonstrates that an alternative design or system (which may include sprinklers) achieves a level of life safety of the building occupants, equal to or greater than that provided by the sprinklers. The required engineering analysis must be performed in accordance with guidelines established by the General Services Administration which are included in this Guide in Appendix B.

**Rebuilt Multifamily Housing Properties** is required to be brought into compliance during rebuilding with the requirements of the chapter on existing apartments (Chapter 19) of the Life Safety Code, NFPA 101. Compliance can be achieved by meeting one of four “options”



provided in NFPA 101. The appropriate smoke detection, alarm and sprinkler protection depends on which option is selected.

**Other Dwelling Units** are required to be protected by hard-wired or battery-operated smoke detectors in accordance with NFPA 74, which is now Chapter 2 of NFPA 72, the National Fire Alarm Code. Owners of units who installed battery-operated or hard-wired smoke detectors prior to April 24, 1993 in accordance with HUD requirements including those published on July 30, 1992 (57 FR 33846) will not be required to comply with any additional requirements mandated by this law.

**State and Local Requirements** in effect in the jurisdiction in which the property is located will take precedence over the requirements of the law only if they are more stringent.

### ***II.3 Minimum Requirements For Installed Alarm and Sprinkler Systems***

Minimum requirements for alarm and sprinkler systems are dependent on the HUD property category. Such requirements are outlined in this section based on the protection levels associated with each of the three HUD property categories:

- I. Newly Constructed Multifamily Housing Properties,
- II. Rebuilt Multifamily Housing Properties, and
- III. Other Dwelling Units.

**II.3.1 Newly Constructed Multifamily Housing Properties** will require both sprinklers (except for properties located in New York City for which an engineering analysis performed in accordance with the requirements in Appendix B demonstrate that an equivalent level of life safety for building occupants is provided) and hard-wired smoke detectors. The three sprinkler standards cited in the law are NFPA 13, 13D, and 13R. The scope of NFPA 13R includes sprinkler systems in multifamily residences up to and including four stories in height and will therefore apply to newly constructed multifamily properties up to four stories. NFPA 13 applies to all other sprinkler installations in this category. NFPA 13D applies to one and two family residences and mobile homes and therefore cannot be used under this property category.

**The minimum requirements for alarm equipment include the following:**

A local alarm system with manual pull boxes and activation to sound indicating devices throughout the building on the flow of water in the sprinkler system is required for all spaces outside of individual apartments EXCEPT where tenant separations are greater than 3/4 hour fire rated **and** each apartment has an independent exit or stairway to grade. In all cases, hard-wired, single- or multiple station smoke detectors sounding only in the apartment of origin are required within all apartments. Here, hard-wired means that the detector is powered by the commercial light and power system (120 VAC). Battery operated detectors are only permitted in existing construction. Figures II.1(a) and (b) provide illustrations of “typical” household multiple-station smoke detector systems.

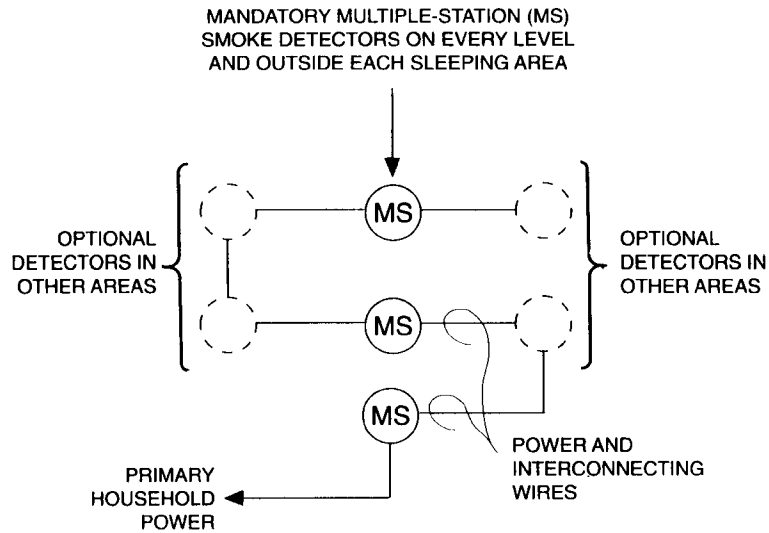

Figure II.1(a) Typical household multiple-station smoke detector system.

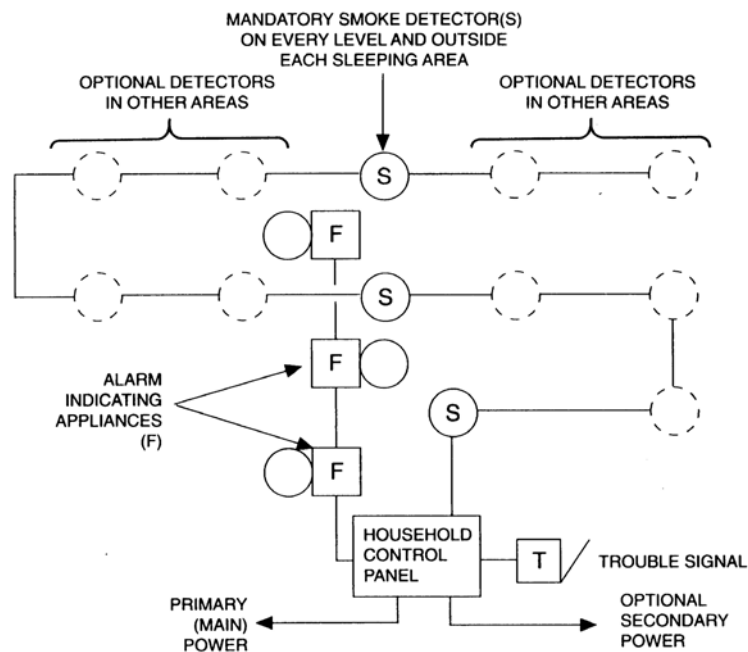
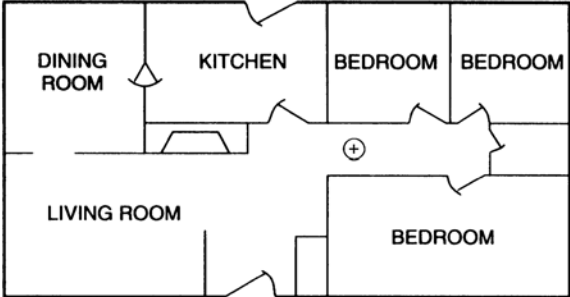

Figure II.1(b) Typical household fire alarm system with separate control panel.

Reprinted with permission from *Fire Alarm Signaling Systems*, Bukowski and O'Laughlin, 2nd edition, Copyright ©1989, National Fire Protection Association, Quincy, MA 02269. This reprinted material is not the complete and official position of the National Fire Protection Association on the referenced subject which is represented only by the standard in its entirety.

The number of smoke detectors required in each apartment will vary. They are required “... outside each, separate sleeping area (Figures II.2(a) and (b)) and on each additional story of the dwelling ...(Figures II.3(a) and (b)).” Since most apartments occupy only one story, this will generally require only one detector unless the bedrooms are in more than one area. Further, in new construction smoke detectors are required in every sleeping room, except where the dwelling unit/apartment is protected by automatic sprinklers. Since sprinklers are required in this housing category, individual sleeping room smoke detectors are not required. Multiple detectors in the same dwelling unit must be interconnected such that when one activates, they all alarm.



2

Figure II.2(a) A smoke detector should be located between each sleeping area and the rest of the family living unit.

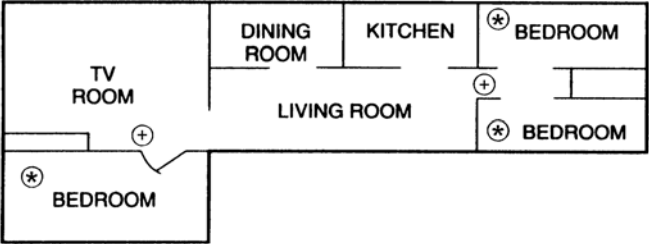

Figure II.2(b) In family living units with more than one sleeping area, a smoke detector (indicated by +) should be provided to protect each separate sleeping area. In new construction, additional smoke detectors are required within each bedroom unless protected by automatic sprinklers (indicated by \*.)

---

Reprinted with permission from *Fire Alarm Signaling Systems*, Bukowski and O’Laughlin, 2nd edition, Copyright ©1989, National Fire Protection Association, Quincy, MA 02269. This reprinted material is not the complete and official position of the National Fire Protection Association on the referenced subject which is represented only by the standard in its entirety.

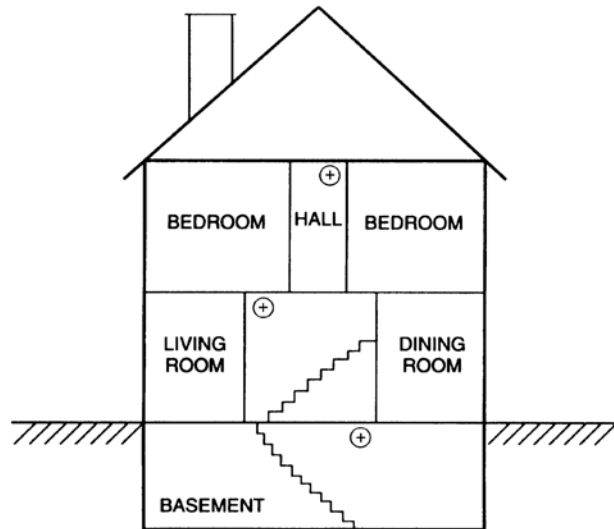

Figure II.3(a) As a minimum, a smoke detector should be located on each story.

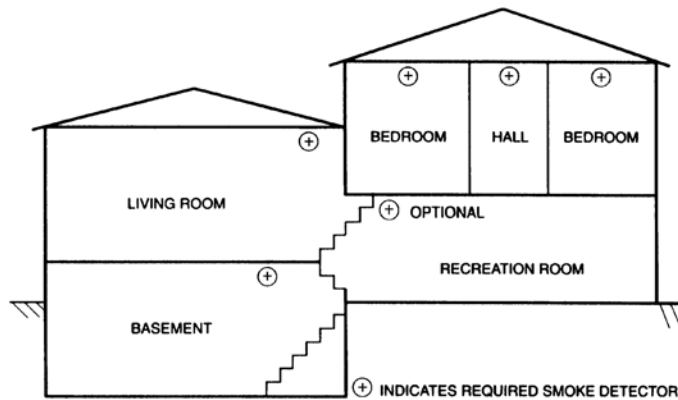

Figure II.3(b) Required smoke detectors in a split-level arrangement. (The indicated smoke detector is optional if no door is provided between split-level living and recreation rooms.)

**The minimum requirements for automatic sprinklers under NFPA 13 include the following:**

Full coverage/exempted areas. The building must be fully sprinklered, including the dwelling units, the common areas such as corridors and lobbies, and building service areas. Standard sprinkler heads are required throughout the building with residential sprinklers permitted in the dwelling units and their adjoining corridors.

Several areas within the dwelling units may be exempted from sprinkler coverage, depending on the type, size, and construction of the space. Such spaces include bathrooms 55 sq. ft or smaller in area, and clothes closets, linen closets, and pantries no larger than 24 sq. ft with the smaller dimension (i.e., width or length) not exceeding three feet. All exempted areas must have noncombustible or limited combustible interior finish having a 15-minute thermal barrier in accordance with NFPA 220, Standard on Types of Building Construction including behind “plastic” fixtures or tub surrounds. Figure II.4(a) and (b) illustrate typical sprinkler layouts in adjacent apartments. In Figure II.4(a) “pendant” type sprinklers are installed in all areas of the dwelling, including the bathrooms. Note that closets met the exemption criteria and were not sprinklered. In Figure II.4(b) “sidewall” type sprinklers are installed in the apartments. In this case, both bathrooms and closets met the exemption requirements. In both examples, the utility closets (e.g., mechanical or HVAC) are sprinklered.

**Advisory:** *If bathrooms are equipped with plastic fixtures or tub surrounds the wall behind such items must meet the combustibility requirements. If the plastic tub surround or fixture(s) do not meet the combustibility requirements and are installed directly to the studs without a qualified subwall such as 1/2 inch gypsum board behind it, the bathroom must be sprinklered.*

Water demand. Water demand is determined using the area/density hydraulic method outlined in NFPA 13 for light hazard occupancies. The “worst case” flow rate and pressure is calculated for the most remote area of the sprinkler system and is added to fire hose flow requirements. Typically, remote common areas can include up to 12 sprinklers, but the number will vary depending on the type of sprinkler head selected. Within dwelling units, the number of sprinklers to be included in the design area is limited to four. Examples of typical four-sprinkler design areas for dwelling units and adjacent corridors are provided in Figure II.5.

The water supply must provide at least a 30 minute duration of the required flow rate. Water supply piping to the sprinkler system must be separate from the domestic water system, although where they separate is regulated by local utility policy. It is preferable for the sprinkler system to come off before the meter to avoid hydraulic losses from the meter. If the sprinkler piping comes off after the meter, a 1” or larger meter may be required. Some utilities also require a backflow preventor which adds more losses and cost. It would pay to negotiate this with the utility.

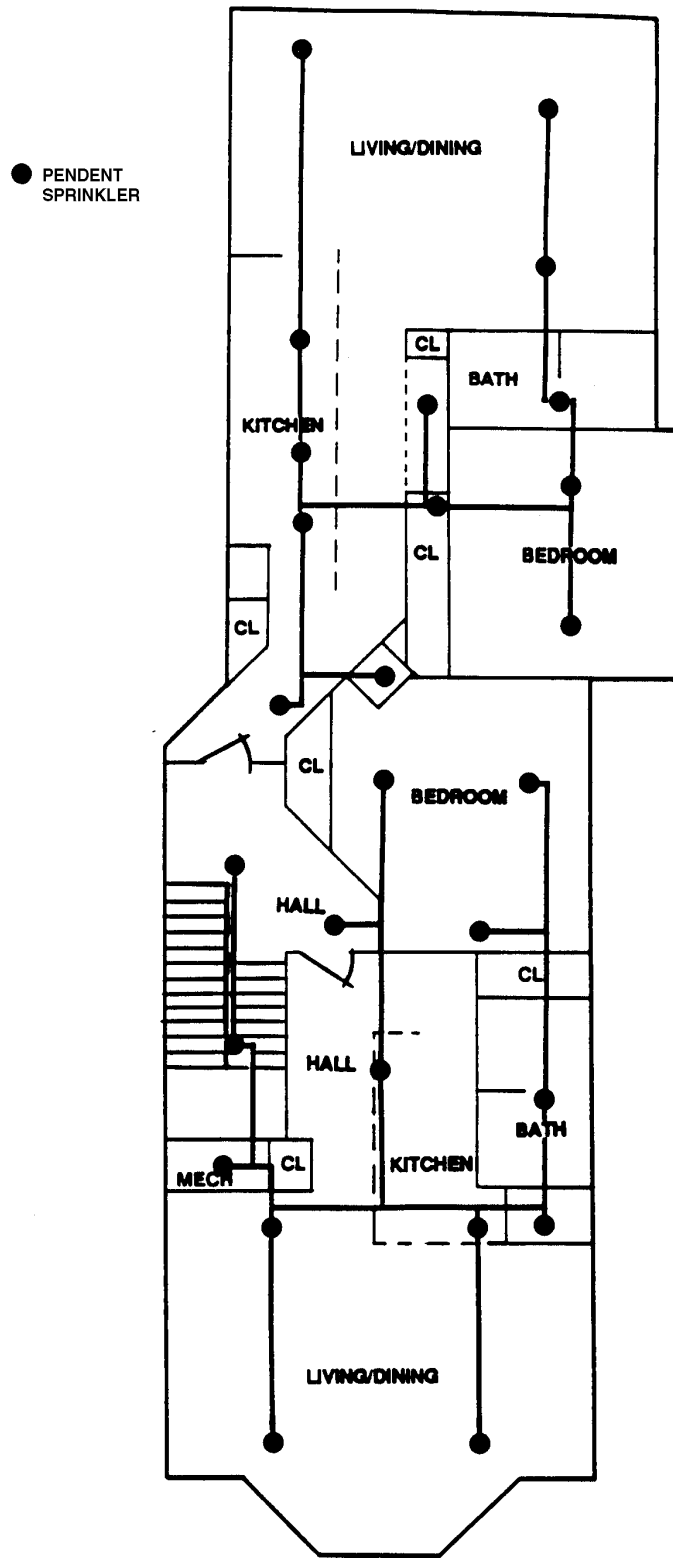

Figure II.4(a) Typical “Pendent” Sprinkler Layout for Apartments (bathrooms not exempted.)

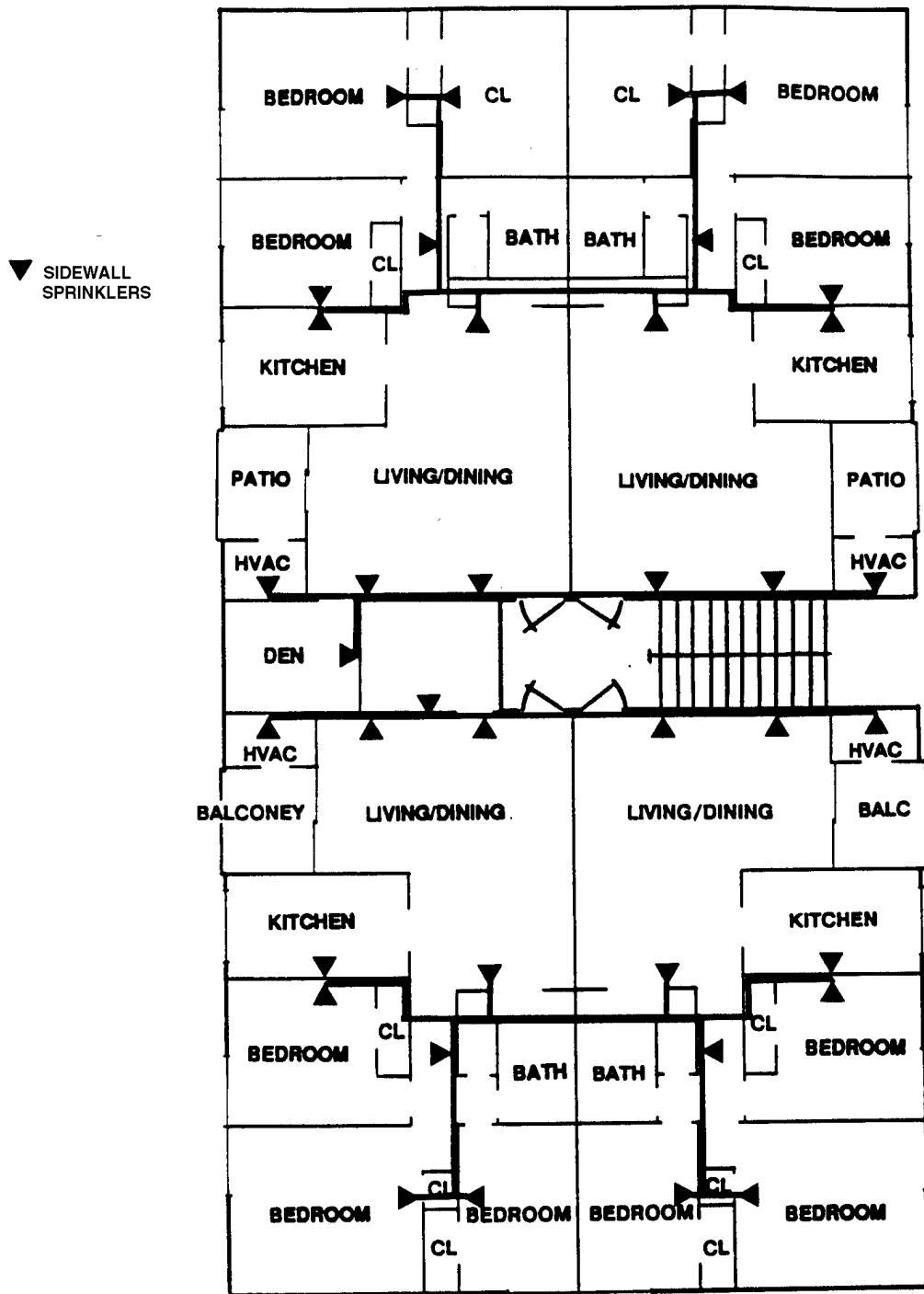

Figure II.4(b) Typical “Sidewall” Sprinkler Layout for Apartments (bathrooms meet the exemption.)

**Advisory:** *Individual sprinkler devices are designed to operate over different areas of coverage. The common spray sprinkler usually covers a minimum of 125 - 144 sq. ft. in residential building applications. However, sprinklers are available that can increase the area of protection for each sprinkler (e.g., to a maximum of 400 ft<sup>2</sup> per sprinkler), potentially requiring considerably fewer sprinklers. These sprinklers are referred to as “extended coverage” sprinklers and are available in both pendent and sidewall designs. The maximum square or rectangular area of coverage for these sprinklers are defined in the “listing” information for the device, along with the water demand requirements to be used in determining the water demand for the system.*

*A “qualified” design contractor should optimize system design wherever possible to reduce the number of sprinkler heads and the amount of piping in order to reduce system cost.*

Alarm/supervision. Electrical supervision of the supply valves, including connection to the fire alarm system, and local water flow alarm are required on all sprinkler systems having more than 20 sprinkler heads.

**The minimum requirements for automatic sprinklers under NFPA 13R include the following:**

Full coverage/exempted areas. While the standard requires that a building be fully sprinklered, more areas of the building can be exempted from coverage than permitted in NFPA 13. Additional exempted areas include: porches, balconies, corridors, open/attached stairs, attics, penthouse equipment rooms, crawl spaces, floor-ceiling spaces, elevator shafts and other concealed spaces not used for living or storage.

Water demand. The water demand is limited to supplying up to a maximum of four sprinklers in any individual dwelling unit. The four sprinkler maximum water supply also applies to areas outside the dwelling units that meet maximum area requirements. Depending on the building geometry and sprinkler design, the water demand could be considerably less than for comparable designs under NFPA 13, and easier to meet by typical domestic water systems. Figure II.5 provides illustrations of typical design areas within dwelling units, including adjacent corridors.

Alarm/supervision. Systems designed and installed in accordance with NFPA 13R are required to provide a local water flow alarm, and be connected to the building’s fire alarm system if one is provided.



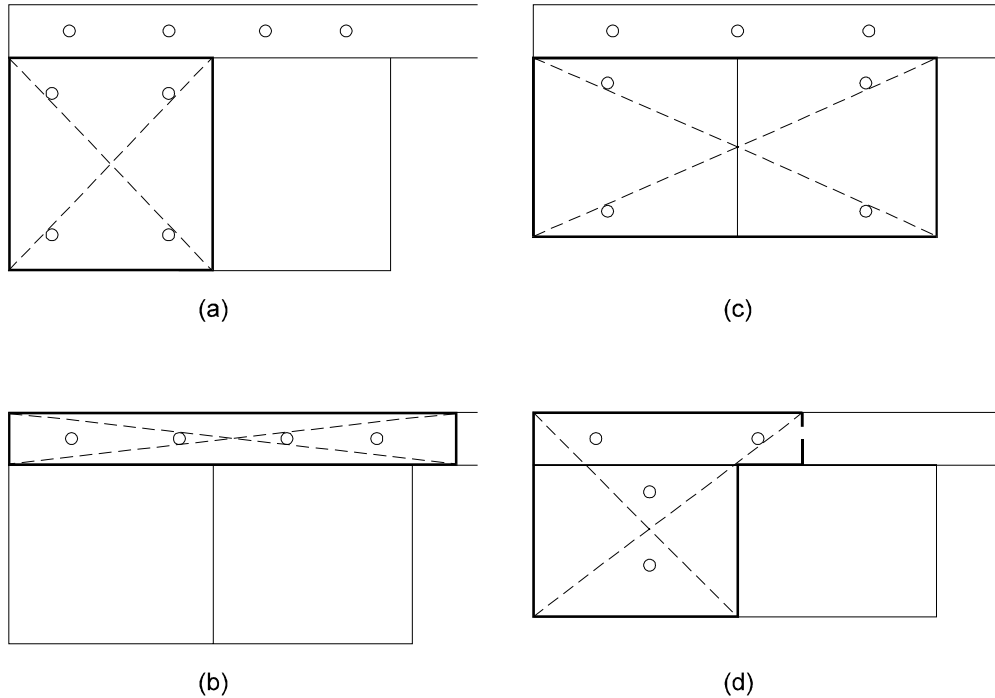

Figure II.5 Examples of the four-sprinkler design area for dwelling units in conformance with NFPA 13. Reprinted with permission from *Automatic Sprinkler Systems Handbook*, Copyright©1991, National Fire Protection Association, Quincy, MA 02269.

**Advisory:** *There are advantages associated with selection of NFPA 13R as the governing standard whenever possible. For example:*

- (1) *frequently the public water supply is adequate without the addition of expensive fire pumps or water tanks;*
- (2) *greater flexibility regarding areas that can be exempted from coverage without significant increase in risk to the building residents;*
- (3) *significant reduction in costs associated with component specifications.*

**II.3.2 Rebuilt Multifamily Housing Properties** must be brought into compliance with Chapter 19 of the Life Safety Code (NFPA 101). Since Chapter 19 adopts requirements from Chapters 1-7 and 31, these are also required in order to comply strictly with the law. Examples of requirements from other chapters adopted by reference include the design and arrangement of the exit system, exit signs and emergency lighting, stair details, protection of vertical openings, interior finish, elevators, and active fire protection systems.

Due to the complexity of these requirements it is not practical to provide detailed assistance in this guide. The following represents only an overview of the alarm and sprinkler approaches permitted in Chapter 19 of NFPA 101.

**Advisory:** *It is strongly recommended that the field office contract with a qualified fire protection engineering firm to make specific design accommodations.*

Chapter 19 allows considerable flexibility with respect to the protection provided in that it recognizes four optional protection schemes:

1. No alarms or sprinklers
2. Complete detection
3. Partial sprinkler (6 or fewer floors only)
4. Complete sprinklers (required for greater than 6 floors)

A specific partial sprinkler system is required under Option 3, and a complete sprinkler system is required under Option 4. The minimum alarm system requirements for Option 2, 3 or 4 are the same as those for the new multifamily property category except Option 2 requires complete smoke detection (every 30 feet in corridors and for each 900 ft<sup>2</sup> or less in other spaces of the building).

The Life Safety Code<sup>7</sup> defines the maximum travel distance as the linear distance measured on the floor or walking surface along the centerline of the natural path of travel starting from the most remote point subject to occupancy, curving around corners or obstructions with a 1 ft clearance and ending at the center of the exit doorway.

Which of these options are available for use in a specific property depends on the maximum travel distances present:

- Maximum travel distance **within** the apartment to the corridor door  $\leq$  75 ft, Options 1 or 3.
- Maximum travel distance **within** the apartment to the corridor door  $\leq$  125 ft, Options 2 or 4.
- Maximum travel distance from the apartment to the closest protected exit (e.g., the door to an enclosed stairway)  $\leq$  100 ft, Option 1.
- Maximum travel distance from the apartment to the closest protected exit (e.g., the door to an enclosed stairway)  $\leq$  150 ft, Option 2 or 3.
- Maximum travel distance from the apartment to the closest protected exit (e.g., the door to an enclosed stairway)  $\leq$  200 ft, Option 4.

**Advisory:** *In some cases, it may be less expensive to add partitions which reduce the travel distance and qualify the property under Option 1 or 2 rather than to retrofit a sprinkler system under Option 3 or 4.*

**Sprinkler coverage requirements** for rebuilt multifamily properties of four to six stories are contained in Chapter 19 of the NFPA 101 Life Safety Code. Under Chapter 19, a rebuilt building must fully meet the requirements of one of four protection options. Only Options 3 and 4 involve the use of automatic sprinklers.

**Option 3: Partial coverage.** Permits partial sprinkler systems to be installed to protect common path corridors and hazardous common areas. This design option is intended to compensate for inadequacies in fire resistance of construction, flame spread ratings of interior finish, and travel distances which already exist in the building and would be prohibitively costly to alter to comply with the basic requirements of NFPA 101, Chapter 19.

Installation requirements are governed by NFPA 13 or 13R, depending on the building height. It should be noted that partial sprinkler systems are not permitted in either NFPA 13 or 13R. However, such systems are permitted under NFPA 101 provided that all other installation requirements of the appropriate sprinkler standard are met.

For buildings that are four stories in height, either NFPA 13 or 13R can be selected for compliance. If the building is five or six stories, NFPA 13 is the appropriate standard.

Under Option 3, corridors outside dwelling units are to be protected by automatic sprinklers. In addition, a single sprinkler is required to be installed inside each dwelling unit unless the entrance door has a 20 minute fire endurance rating and is self closing.

Hazardous areas such as utility rooms, laundry rooms, storage areas, etc. **may** be sprinklered as a substitute for fire resistant construction.

Water demand. Water demand is determined by the area/density method provided in NFPA 13. However, in the event that sprinklers are installed in the dwelling units (not required), the use of residential or other quick response sprinklers in the dwellings is encouraged.

**Advisory:** *Under certain circumstances the “room design method” (referred to as the small room method) may be used to calculate the water demand. Under this method, the sprinkler water demand is based on the demand for the room requiring the greatest water demand and may be significantly lower than that determined by the area/density method. When applying this method, certain requirements for enclosure integrity and fire resistance must be met.*

Alarm/supervision. Electrical supervision of supply valves and water flow alarm are required with connection to the building’s fire alarm system if one is provided.

**Advisory:** *While partial sprinkler systems are prohibited in NFPA 13 or 13R, provision for this option in NFPA 101 for rebuilt properties may allow an otherwise noncompliant building to qualify under the HUD rebuilt multifamily residence category in the most cost effective manner available.*

**Advisory:** *Whenever possible it is recommended that NFPA 13R be selected as the governing standard; i.e., for any rebuilt buildings four stories or less in height. Additional cost savings may be achievable without significant increases in resident risk.*

**Option 4:** Full coverage/exempted areas. Applies to rebuilt buildings greater than six stories in height. Under NFPA 101, such buildings are required to be sprinklered throughout. The governing installation standard is NFPA 13.

The requirements of NFPA 13 apply in terms of the types of sprinklers to be used, exempt coverage areas, and water demand. The use of residential sprinklers is encouraged, and exempted areas include bathrooms and closets in the dwelling units that have noncombustible or limited combustible interior finish materials with a 15 minute thermal barrier per NFPA 220, Standard on Types of Building Construction.

**Advisory:** *If bathrooms are equipped with plastic fixtures or tub surrounds the wall behind such items must meet the combustibility requirements. If plastic fixtures or tub surrounds are installed directly to the studs without a “qualified” subwall behind it, the bathroom must be sprinklered.*

Alarm/supervision. Electrical supervision of supply valves and water flow alarm must be provided, and connected to the local alarm system when one is provided.

**Advisory:** *Major tradeoffs in construction requirements, including fire resistance, travel distances, flame spread rates, etc. are permitted if option 4 is adopted. Avoidance of major construction modifications may represent a significant potential for cost savings.*

**Advisory:** *Under Options 1 or 2, it may be possible for a given property to comply without any sprinkler system if the maximum travel distances are short enough. In these cases, the minimum protection would consist of hard-wired smoke detectors in every apartment. Here, battery powered detectors are acceptable and interconnection to sound all devices at once is not required.*

**II.3.3 Other Dwelling Units** require the installation of single- or multiple-station smoke detectors. They are required to be installed outside each separate sleeping area and on each additional

story of the home, excluding unfinished attics or crawl spaces. In new construction they are also required within each sleeping room, all must be powered from the 120 vac supply, and must be interconnected so that all detectors sound when any one is activated.

In existing dwellings, detectors are not required within sleeping rooms, they may be battery powered, and they are not required to be interconnected to sound the alarm in all units. However, all detectors must be "... clearly audible within the bedrooms with all intervening doors closed and any appliances (such as window air conditioners) on." This latter requirement may dictate interconnection of remote detectors to those near the bedrooms. The term "clearly audible" is defined as producing a sound level of 15 dBA above the ambient noise level in the space.

There are no requirements for automatic sprinkler protection in Other Dwelling Unit properties.

## ***II.4 Additional Considerations***

In the previous sections, the minimum requirements under the law were presented. However, the quality of protection provided can be significantly enhanced and numerous problems can be avoided if certain guidelines are followed in the procurement of systems to comply with the law.

All of these fire protection systems, from simple smoke detectors to complete sprinkler systems must be **designed** for the specific installation by persons qualified to do so. The first step is to hire only qualified contractors to do the work. A discussion of minimum qualifications follows, along with other important considerations for both alarm and automatic sprinkler systems. A sample Statement of Work suitable for inclusion in government contracts is provided in Appendix A. Also included in Appendix A are standard forms for approval testing of sprinkler systems and maintenance/testing records for alarm and sprinkler systems.

### **II.4.1 Fire Alarm Systems**

Contractor Qualifications: There is a national program for the certification of persons who design and install fire alarm equipment run by the National Institute for the Certification of Engineering Technicians (NICET). Under the NICET program, persons progress through a series of levels by a combination of self study, on-the-job training, and passing written examinations. There are significant differences between ordinary electrical wiring techniques and the installation of fire alarm equipment, so general electrical contractors are not necessarily qualified or capable of doing alarm work unless they are NICET certified or factory trained by the manufacturer of the alarm equipment (but then only for the installation of that manufacturer's equipment).

Therefore, it is crucial that the system design, including specification of the number, type, and location of devices for the specific installation be performed by a person holding a NICET Level 3 certification. Actual installation should be done by persons with a NICET Level 1, supervised by a NICET Level 2. The only exception is for single- or multiple-station

smoke detectors. While the selection of type, number, and location should be done by a NICET Level 2 or higher, the actual installation can be done by a general electrician since these devices are wired the same as a light fixture. The primary cause of alarm system failures is intentional disconnection by the homeowner due to excessive false alarms, and the primary cause of false alarms is incorrect location of detectors. NICET certified designers know the places to avoid locating detectors to minimize false alarm problems.

**Advisory:** *The field office should take adequate precautions to insure that only qualified designers and installation contractors are used. Lack of competence and experience can result in non-compliant installations, poor cost effectiveness, and a reduction in the intended level of life safety.*

Coverage Areas: Fire statistics from the U.S. Fire Administration show that you are 2 ½ times less likely to die in a house fire where the home is protected by smoke detectors. In ten independent studies conducted in four countries over a 20 year period, 206 full-scale fire experiments in actual houses and apartments with actual smoke detectors were conducted to examine their performance in providing safety for occupants. These tests showed the following:

- smoke detectors on each floor level of the home provided the most cost-effective protection,
- either the ionization or photoelectric types of detectors provide adequate warning, and
- the addition of heat detectors provided little additional protection.

As a result of this research, the National Fire Alarm Code (NFPA 72) currently requires only smoke detectors for protection of residences. Supplementary heat detectors are permitted for the protection of spaces where smoke detectors may not be installed, such as in kitchens, attics or garages.

Reliability/False Alarms: In the recent report of the National Smoke Detector Project conducted by the Consumer Product Safety Commission, National Fire Protection Association, the Congressional Fire Services Institute, and the U.S. Fire Administration, data obtained from field tests of smoke detectors in 1200 American homes was reported. It was found that about 13% of the detectors tested were unpowered, most of these having been disconnected by the homeowner after an excessive number of false alarms. Therefore, if the protection envisioned in Public Law 102-522 is to be achieved, false alarms must be minimized. This requires care that the right detectors are located in the right places.

The greatest source of false alarms is cooking, followed by steam from showers. Both of these problems can be minimized by careful location of smoke detectors. Detectors should never be located in kitchens or within about three feet of the door to a kitchen or bathroom containing a tub or shower. In a small apartment where the detector cannot be located far from the cooking area, the use of a photoelectric detector is preferred since they are less prone to react to cooking. Since smoke flows along the ceiling, the existence of a soffit will

help impede the flow of smoke from cooking from reaching the smoke detector. In a fire, the larger quantity of smoke produced will activate the detector in time regardless of the soffit.

Hard-wired smoke detectors required by Public Law 102-522 are powered from the 120 VAC power available in the dwelling. NFPA 72 allows these to be either dedicated branch circuits or circuits which also supply lights and receptacles. Some experts feel that the latter is preferable since it is less likely that the homeowner will turn off the power to the detector if it means that some lights or outlets will not work. Some interconnected detectors can be damaged if different detectors are powered from different phases of the AC supply. A qualified alarm installer should know this, but where general electricians are being used, this should be pointed out to them.

Power Sources: Another consideration is the power source for single- and multiple-station smoke detectors. The law and its referenced standards require AC powered in new construction and permit battery power in existing. Operation from AC power is advantageous in any installation since the homeowner does not have to change batteries, but the additional cost of wiring can be prohibitive. Certainly, if other wiring upgrades are being made, or if the wall finishes are being replaced, it is a good idea to install AC powered detectors.

Whenever AC powered detectors are being installed, AC with battery backup should be utilized. These detectors have a 9 volt battery which powers the detector if the AC is off. The incremental cost of these models is small over the AC only versions and installation cost is the same. Running in a backup mode, the batteries last 6-7 years before they need to be replaced, so the burden on the homeowner is minimal. The additional reliability is well worth the additional cost, and several court cases have held landlords liable for detectors not working during power failures because detectors with backup power are readily available at small additional cost so it is “reasonable” to do.

Alarm/Supervision: It is important to understand that single- and multiple-station smoke detectors can be used **only** within individual living units. They should not be connected into a building fire alarm system, but it is permitted to utilize a remote signaling device which produces a supplementary signal in a specific location. This can include signaling at an attended location (e.g., a manager’s office or front desk) in cases where there might be no one at home or where disabled or elderly occupants might need evacuation assistance. Activating a building evacuation signal is prohibited because of the relatively high rate of false alarms from smoke detectors in living units and the associated loss of credibility of the fire alarm system.

Where alarms are required in common use areas of multifamily properties, a fire alarm system consisting of separate detectors, sounders, and a control panel, is required. Such systems can be arranged to transmit alarm signals automatically to the fire department or to a monitoring station. This is not required by the law and is generally not necessary in residential properties since they are seldom devoid of any occupants who can call the fire department.

In properties with both sprinklers and fire alarm systems (not just single-station alarms), the sprinkler system should be connected to the alarm system to sound the alarm whenever the

sprinkler system is flowing water. This is done through an inexpensive waterflow switch and is a very good idea, both from the viewpoint of fire protection and to minimize water damage from a sprinkler system problem (e.g., a frozen pipe, mechanical damage, or vandalism). The alarm system can also be used to provide inexpensive monitoring of sprinkler shut-off valves so that they cannot be inadvertently left off.

Where remote monitoring of the system is desired, control panels are needed to provide such an interface. These systems transmit signals to a monitoring service by connection to the telephone line. They are programmed to automatically dial the service and report via a device called a Digital Alarm communicator (DAC). Other devices called Tape Dialers should never be used as they are unreliable. Remote monitoring of the system is recommended for sprinklered properties since this includes supervision of water supply valves, and it assures rapid notification of the fire department and minimizes the potential for water damage.

Provisions for the Hearing Impaired: A new area within the National Fire Alarm Code is the requirements for flashing lights to accommodate persons with hearing impairments. Chapter 2 places the responsibility on the occupant to notify appropriate persons of their need for such accommodation, and the builder or landlord is then responsible for providing the equipment. Within the individual living unit each single- or multiple-station detector must be provided with a low intensity (15 candela minimum) strobe light which can be powered from a battery or from AC. The bedroom in which a hearing impaired person sleeps must be equipped with a high intensity strobe which is powered from the AC. This light must produce at least 177 candela if mounted on the ceiling, or 110 candela if mounted at least 24 inches below the ceiling.

In the common areas of multifamily properties in which hearing impaired persons live, strobe lights are required in addition to audible devices. The number, location, and intensity of these devices are specified in Chapter 6 of the National Fire Alarm Code (NFPA 72). In larger spaces where more than one strobe light can be in a person's field of view, the strobes should be synchronized to flash together (unsynchronized strobes can cause seizures in some persons with epilepsy). In spaces with single strobes, unsynchronized devices reduce costs because they place less demand on system power supplies.

The requirement for design by a NICET Level 3 or higher contractor should assure that all of these factors are considered for every installation since these represent requirements in the referenced standards or good engineering practice.

#### **II.4.2 Automatic Sprinkler Systems**

Contractor Qualifications: A NICET program has also been set up to certify individuals who provide detailed design and installation of automatic sprinkler systems. Typically, basic design is performed by a licensed fire protection engineer (PE) or certified architect. Detailed design and sprinkler system layout should be performed by an individual certified as a NICET Level III sprinkler system designer, with review being performed by a NICET Level IV or a licensed fire protection engineer (PE).



Installation should be performed by a crew where the ratio of qualified “fitters” to apprentices is 1:1. A fitter is an individual with a minimum of five years of installation experience. A fitter is expected to be fully knowledgeable regarding the detailed requirements of the applicable codes and standards and is responsible for installation compliance. There are no requirements for an apprentice.

Frequently, local jurisdictions will have additional requirements for both designers and installers.

**Advisory:** *Under some jurisdictions non-NICET qualified installers (e.g., plumbers) may be permitted to install sprinkler systems using nonmetallic piping. Caution is recommended in permitting such practices since most plumbers are not familiar with the detailed requirements of the standards and may overlook important design/installation features, resulting in an inferior installation that could reduce the intended level of life safety.*

**Sprinkler Coverage:** The use of partial sprinkler systems to compensate for deficiencies in fire resistance, interior flame spread and egress for Rebuilt Multifamily Housing should not be misconstrued as meeting the requirements of a sprinklered building under NFPA 13, 13R or the local building code. However, partial systems can provide considerable benefits in both reducing the life safety risk due to hazardous areas of the building, and reductions in insurance premiums.

If extensive use of partial systems is required to satisfy the requirements in NFPA 101, Chapter 19, consideration should be given to installation of a complete sprinkler system in compliance with NFPA 13 or 13R, whichever applies. The additional cost may be recouped in only several years based on reductions in the insurance premiums. And, the reliability of a complete system is significantly greater than for isolated partial systems. NFPA has no record of a multiple fatality fire in a “fully” sprinklered building.

Areas of residential buildings that are exempted from sprinkler coverage under NFPA 13 or 13R have been identified based on review of national fire incident data. These areas are estimated to have little or no effect on the actual fire risk and may provide significant economies in terms of installation costs.

**Water Supply:** Having a reliable, adequate water supply is critical to satisfactory performance of a sprinkler system. In addition to basic considerations such as the amount of water required, the system pressure, and duration of flow, there are several other issues which require attention.

**Service Interruption:** The most frequent cause of water service interruption is a closed control valve. Steps should be taken to minimize the potential for such an event. For example, wherever possible the water supply should be arranged so that the only way to shut off the sprinkler water supply is to shut off the domestic service as well. Requirements for separate domestic and sprinkler water supplies in NFPA 13 limit such actions. However, this

can be readily accomplished under NFPA 13R as illustrated in Figure II.6 for a typical residential building.

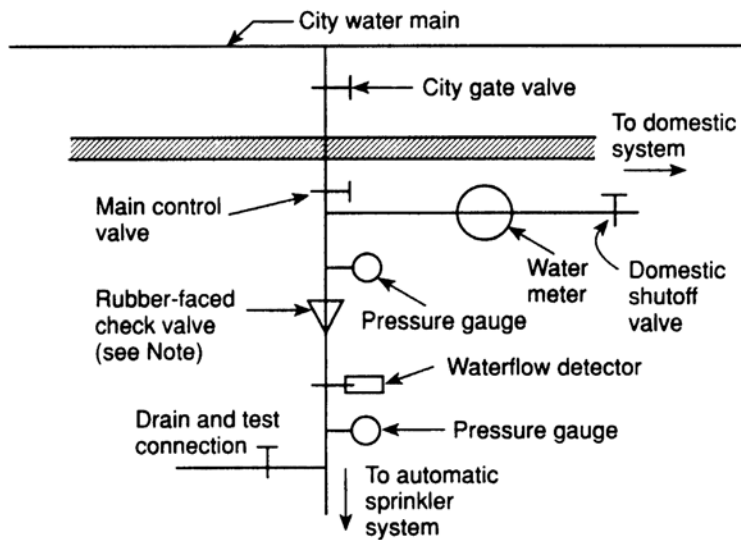

NOTE: Rubber-faced check valves optional.

Figure II.6 Preferable arrangement.

Reprinted with permission from NFPA13R, *Installation of Sprinkler Systems in Residential Occupancies up to and Including Four Stories in Height*, Copyright©1994, National Fire Protection Association, Quincy, MA 02269. This reprinted material is not the complete and official position of the National Fire Protection Association on the referenced subject which is represented only by the standard in its entirety.

**Water Quality:** Sprinkler piping can be degraded rapidly due to chemical or microbial induced corrosion. Local water quality should be tested to insure that such effects will be minimal. Where possible, such effects can be reduced dramatically by the use of non-metallic piping (e.g., plastic) listed for such usage.

**Backflow Protection:** Frequently, the local water authority requires installation of backflow protection in the sprinkler system to insure that water from the sprinkler system does not drain back into the domestic system in the building or the city water supply. Considerable controversy exists over this requirement. The cost of backflow devices can be high, adding considerable cost to the sprinkler system. Recent studies indicate that simple “single check valves” provide adequate backflow protection and are the least expensive available backflow devices. Figure II.6 illustrates a typical installation of a single check valve that serves as backflow protection.

**Advisory:** *The water authority usually has the last word on the need and type of backflow protection device(s). It is advisable to obtain the services of a qualified fire protection engineering firm to address this issue with the local water authority if the potential exists for significant cost impact for the property under consideration, or if it is anticipated that HUD will be involved in other similar projects in this jurisdiction.*

**Freezing:** Extensive requirements exist in NFPA 13 regarding protection of sprinkler systems against freezing. While several design alternatives are available, including the use of dry pipe systems and using antifreeze solutions, these alternatives should be considered as last choices. The impact on life safety performance and the reduction in reliability due to added hardware should always be considered. Therefore, it is recommended that wet pipe systems be installed wherever possible and appropriate cautions be evoked to minimize the potential for freezing.

**Advisory:** *While not required, it is a good design practice in areas subject to freezing to install sprinkler piping in the interior walls. Exterior wall installations have resulted in freezing under severe conditions.*

**Advisory:** *If sprinkler piping is installed above the ceiling in an unheated attic space specific installation practices must be met. Such practices are frequently provided by the insulation manufacturer. Figure II.7 provides illustrations of how to install sprinkler piping and attic insulation to prevent freezing of the sprinkler piping. There have been many instances where improper installation of the attic insulation have resulted in freezing sprinkler pipes and pipe failures.*

**Seismic Protection:** The loss of a sprinkler system due to a minor seismic event is a serious reliability problem. Where needed, proper installation of sprinkler piping should include the use of flexible pipe couplings, sway bracing, etc. In areas required to be protected against earthquakes (guidance provided in NFPA 13), contractors must demonstrate competence in performing these unique design requirements.

■ Indicates Insulation

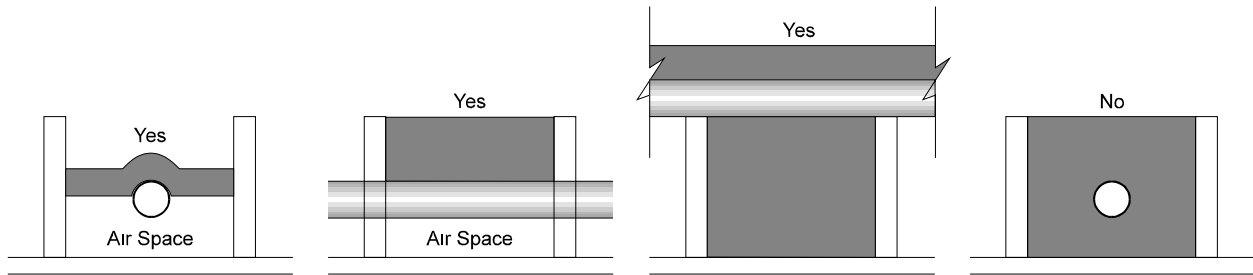

Figure II.7 Examples of proper thermal insulation in attics containing sprinkler piping.

**Alarm/Electrical Supervision:** All sprinkler systems should include a local water flow alarm in accordance with NFPA 70, the National Electrical code, Article 760. Such an alarm will notify the residents in the event that the sprinkler system goes off. In addition, the system should always include electrical supervision connected to the alarm system when one is available. These features are important in order to notify building residents and local fire departments in the event that a sprinkler system flows water; such a condition could indicate a fire or a false activation. Both types of incidents require response by the building residents and local emergency organizations.

**Sprinkler Type:** Residential or quick response sprinklers should be used whenever possible. These sprinklers are designed to respond rapidly to small fires. Considerable research has resulted in residential and quick response sprinkler technology that provides a high level of life safety.

NFPA 13 permits the use of residential sprinklers in residential portions of multistory buildings and their adjacent corridors. There are important life safety advantages to using residential sprinklers wherever possible. In addition, the four sprinkler design area permitted in NFPA 13R is extended to NFPA 13 for the individual dwelling units, potentially reducing the amount of water required by the sprinkler system.

**Component Quality Control:** System components such as sprinkler heads, selected piping, valves, pumps, etc. are required to be “listed” for such use by an organization acceptable to the authority having jurisdiction; e.g., Underwriters Laboratories, Inc. Listed components are labeled as such and can be examined before or after installation by the installer, the building owner and/or the local authority. Qualified installers should be depended upon only to install listed components where required by NFPA 13, NFPA 13R or the local authority.

**System Acceptance Testing:** All installed sprinkler systems must be tested and approved. The installation contractor is required to conduct a series of “approval” tests and document results for transmittal to the authority having jurisdiction. The authority as well as the building owner must be notified of the test schedule and are permitted to observe the testing. Examples of report forms for acceptance testing are provided in Appendix A.

Maintenance: Sprinkler systems must be maintained in accordance with NFPA 25, Water-Based Fire Protection Systems (1992 ed). The building owner has the responsibility for assuring that the sprinkler system is maintained in proper operating condition. This involves routine checking of nonsupervised valves, routine visual inspection of system components and periodic system/water supply flow tests. Such maintenance can be performed by a sprinkler installation contractor or the owner's building maintenance staff provided they are qualified. A recommended schedule for routine maintenance and testing of sprinkler systems is provided in Appendix A.

Building Occupant Information: Guidelines regarding how sprinkler systems work, common misconceptions, and what tenants should do in the event that a sprinkler system goes off should be developed and provided to each tenant. Tenants should be cautioned regarding hanging objects from the sprinklers, not painting the sprinkler heads, maintaining a minimum clearance of 18 inches below sprinklers and immediate reporting of damaged or leaking sprinkler systems. Resources where assistance can be obtained for this effort are provided in Appendix B.

# **Part III. Important Issues in Implementing Automatic Sprinkler Requirements**

## ***III.1 Understanding Sprinkler Technology***

### **What is a fire sprinkler system?**

Fire sprinkler systems are designed and installed to “automatically” spray water onto a developing fire. Such systems are intended to “control” a fire, therefore providing time to escape and limiting the extent of damage. Complete extinguishment is not the intended design objective; but in fact, modern sprinkler systems frequently completely put out fires. The introduction of “residential” sprinklers and other quick response sprinkler technology has further enhanced the extinguishment capability and life safety performance of sprinkler systems.

### **How does a sprinkler system actually work?**

Fire sprinkler systems are activated by heating individual sprinklers beyond a preselected temperature level, normally in the range from 135 to 165 F for residential applications. A misconception associated with these systems is that if one sprinkler opens, all sprinklers open and spray water. In fact, only the sprinklers in the immediate vicinity of the fire typically open, limiting water application to the area of fire origin. Typically, one or two sprinklers are sufficient to control a residential fire.

### **Are all installed fire sprinkler systems the same?**

No. Installed systems can vary considerably, depending on the governing codes and standards that are applied and the selection of hardware components and basic design scheme. However, the performance objectives are the same; to provide a reasonable level of life safety and property protection from fire.

### **Are Sprinklers required in all parts of a building?**

No. Both NFPA 13 and 13R allow certain areas of dwelling units to be exempted from sprinkler coverage. However, limitations associated with both the size of the space and the flammability of the walls and ceiling must be met. NFPA 13R also extends the exempted areas beyond the dwelling units to include common areas, exterior stairs and other areas. In addition, Option 3 of NFPA 101, Ch 19 permits the use of “partial” sprinkler systems to protect selected hazardous areas.

### **What requirements govern the design and installation of fire sprinkler systems?**

Nationally recognized codes and standards include the NFPA 101 Life Safety Code, and NFPA 13 and NFPA 13R sprinkler installation standards. In addition, local jurisdictions may have adopted one of the model building codes with or without local variations as well as local ordinances related to fire sprinkler systems.

### **Are there special qualifications for designers and installers?**

Yes. Typically, basic sprinkler system design is performed by licensed professional engineers or architects. Detailed design and installation are performed by licensed contractors, using certified engineering technicians for the design work and qualified fitters for the installation. Frequently, local jurisdictions will have requirements for both designers and installers.

### **Who is the ultimate approval authority?**

The local Authority Having Jurisdiction (AHJ). Local AHJ's typically have certification requirements for sprinkler system designers and installation contractors. They also have a design approval process, permit requirements, and final system approval testing and certification requirements. All sprinkler installations should comply with the requirements of the local AHJ.

### **How much do sprinkler systems cost?**

While costs vary depending on the geographical location, available labor, etc., typically the cost of installing a sprinkler system in a new building is estimated at \$1.00 to \$1.50 per sq. ft. If the system is being installed in an existing building (i.e., retrofitted) the cost is on the order of 50% higher.

### **Are there ways to recoup the cost of a sprinkler system?**

Yes. Many local AHJ's permit design tradeoffs if an approved fire sprinkler system is installed in the building. In addition, insurance companies routinely provide premium discounts on the order of 15-20% per year.

### **How reliable are fire sprinkler systems?**

Historical records of sprinkler performance indicate an effectiveness level in the 95-99% range, provided that the system is properly installed and maintained. Accidental discharges are extremely rare, estimated at 1 in 16 million sprinklers per year of service. And, insurance records indicate that potential fire damage costs are many times greater than that associated with water damage from a sprinkler system during a fire.

## **What are the common failure modes for sprinkler systems?**

The dominant failure modes include (1) lack of water due to someone shutting off the water, (2) component failure due to poor system maintenance, and (3) component failure due to improper installation (e.g., pipe failure due to freezing or earthquake).

### ***III.2 Steps in the Design/Install Process***

Compliance with the basic automatic sprinkler requirements under the law (PL 102-522) can be accomplished through a five step process, including the following:

#### **Step 1: Identification of HUD Property Category**

The applicable property category should be determined for each candidate property. This should be performed by qualified HUD field personnel or by contractor(s) familiar with the requirements for each of the property categories.

#### **Step 2: Basic Design**

The basic sprinkler design effort is normally performed by a qualified design professional. In selected jurisdictions installation contractors also maintain such expertise. The basic design effort includes several tasks, including the following:

- (a) selection of the applicable engineering standards;
- (b) identification of unusual requirements, local statutes, etc. that may deviate from the requirements in the applicable standards; and
- (c) provision of general guidelines regarding occupancy class, water supply, types of sprinklers, and main system equipment and components.

This step does not include preparation of formal drawings, and could be limited to specification of the applicable standard(s), depending on the extent of conflict between national standards and local statutes.

#### **Step 3: Working Plans/Installation**

This step involves preparation of detailed working plans/shop drawings and specifications, and the actual installation of the sprinkler systems. Typically, a licensed sprinkler contractor is required to perform these services. And, if



problems arise that require further design discretion, they should be referred to a qualified design professional.

**Step 4: Approval Testing**

The licensed sprinkler installation contractor must perform a series of approval tests, document the results, and provide the results to the local Authority Having Jurisdiction (AHJ). Testing includes flow testing of underground water systems, hydrostatic testing of the sprinkler system, water flow alarm tests, and main drain valve tests. Frequently, the AHJ will require witnessing of the tests by its personnel. Results must be documented in writing, and acceptance certificates must be prepared by the sprinkler contractor. (Note: Example forms for acceptance/approval testing are included in Appendix A.)

**Step 5: Inspection/Maintenance Plan**

A routine inspection and maintenance program must be set up by the building owner. Such a plan can be developed and/or conducted by a licensed sprinkler contractor or, if qualified, the owner's building maintenance personnel. NFPA 25, Water-based Fire Protection Systems, provides detailed guidance regarding required inspection and maintenance of sprinkler system components as well as frequency. Example schedules and checklists are provided in Appendix A. Written records should be maintained by the owner.

### ***III.3 Choosing the Right Sprinkler Design Standard***

#### **III.3.1 HUD Property Categories**

As outlined in Public Law 102-522, there are three distinct property categories under consideration for mandated inclusion of automatic sprinkler systems. The type and extent of automatic sprinkler protection required is dependent on the property "category" and the building height. The property categories are (I) Newly Constructed Multifamily Properties, (II) Rebuilt Multifamily Properties, and (III) Other Dwelling Units. Specific requirements or criteria associated with each property category are summarized in Table I.1 (reprinted here for convenience).

Table I.1 HUD Property Categories (from Part I)

HUD Property Category	Elements
I. Newly Constructed Multifamily	(a) $\geq 4$ stories, and (b) $\geq 5$ units under one roof, and (c) constructed after 10/26/92, and (d) HUD assistance used or committed after 10/26/92 Exempted: New properties which received HUD binding commitments for assistance before 11/26/92
II. Rebuilt Multifamily	(a) $\geq 4$ stories, and (b) $\geq 5$ units under one roof, and (c) rebuilt on or after 10/1/94, and (d) HUD assistance or binder before construction began, and (e) cost of alteration $\geq 70\%$ of replacement cost
III. Other Dwelling Units	(a) all other properties $\geq 4$ stories, or (b) multifamily from 1-3 stories, or (c) single family

### III.3.2 Required Levels of Sprinkler Protection and Governing Standards

The required level of automatic fire sprinkler protection is dependent on the HUD property category associated with a particular property. For example, if the property is determined to be “newly constructed,” automatic sprinkler protection is required throughout the building.

The governing standards for the design and installation of automatic sprinklers in HUD properties include the following:

- (1) NFPA 13, Installation of Sprinkler Systems,
- (2) NFPA 13R, Sprinkler Systems in Residential Occupancies Up to and Including Four Stories in Height, and
- (3) NFPA 101, Life Safety Code, Chapter 19, Existing Apartment Buildings.

**NFPA 13** provides detailed design and installation requirements for a broad range of building types, including multistory residential. It is considered the baseline standard for automatic sprinklers and provides a high level of reliability for compliant automatic sprinkler installations.

**NFPA 13R** applies to residential buildings no higher than four stories. Requirements for coverage areas and water supply are potentially less demanding in NFPA 13R as opposed to NFPA 13. These differences have been determined not to compromise the overall reliability of the installed sprinkler systems for this limited occupancy class (i.e., multifamily  $\leq 4$  stories in height), but do provide for the possibility of significant cost savings.

**NFPA 101, Chapter 19** specifically applies to Category II, Rebuilt Multifamily Housing. Of the four fire protection “options” provided in Chapter 19, only options 3 and 4 include

automatic sprinklers. The intent is to permit considerable flexibility in achieving an acceptable level of fire protection in existing structures where compliance similar to that required for new construction would be prohibitively costly and difficult to achieve. For example, in existing buildings not exceeding six stories in height, Chapter 19 permits the use of “partial” sprinkler systems. Such systems are used to protect only the high hazard areas of the building such as furnace rooms or common storage areas.

The required extent of automatic sprinkler protection and the applicable code/standards for fire sprinkler systems are summarized in Table III.1 for each candidate HUD property category. This table provides quick guidance regarding protection requirements and appropriate selection of design/installation standards.

Table III.1 Required Automatic Sprinkler Protection and Governing Code/Standards

HUD Property Category	Required Sprinkler Coverage	Applicable Codes/Standards
I. Newly Constructed Multifamily 4 stories > 4 stories	Complete** Complete**	NFPA 13 or 13R NFPA 13
II. Rebuilt Multifamily <u>Option 3 (NFPA 101, Ch 19)</u> 4 stories 5 or 6 stories <u>Option 4 (NFPA 101, Ch 19)</u> > 6 stories	Partial Partial Complete	NFPA 101* (NFPA 13 or 13R) NFPA 101* (NFPA 13) NFPA 101* (NFPA 13)
III. Other Dwelling Units	None	NFPA 13R or 13D

\* NFPA 101 outlines the sprinkler coverage requirements; NFPA 13 and 13R provide detailed sprinkler system design guidance.

\*\* For buildings in New York City, the automatic sprinklers may be omitted if an engineering analysis demonstrates that an alternative design or system (which may include sprinklers) achieves a level of life safety of the building occupants, equal to or greater than that provided by the sprinklers. The required engineering analysis must be performed in accordance with guidelines established by the General Services Administration which are included in this Guide in Appendix B.

### ***III.4 Selecting the Contractor(s)***

Only qualified contractors should be permitted to design and/or install proposed alarm or sprinkler systems.

Design compliance with local code requirements, selection of the most beneficial design in terms of life safety and cost efficiencies, and selection of appropriate governing engineering standards are all important elements of the basic design task. As discussed in Part II.4.2, licensed engineers and architects experienced in alarm or sprinkler design should normally be used for this initial design task.

In many jurisdictions, local installation contractors are also qualified to perform the initial design task along with detailed design, installation and acceptance testing. For relatively simple designs

there are potential advantages to obtaining all of the necessary services to complete the installation from one contractor. However, for large projects a fire protection or architectural firm experienced in this area can provide general design guidance that may dramatically effect the final installation costs and approval by the local authority.

In identifying fire protection engineering or architectural services, the field office should require that bidders provide documentation of experience and qualifications to perform such services along with evidence of familiarity with the most current hardware technologies. These qualifications are necessary to insure preparation of “cost/beneficial” designs that take advantage of sprinkler hardware advancements in terms of life safety performance and cost.

Potential sprinkler installation contractors should be required to demonstrate qualifications and work experience consistent with the National Institute for the Certification of Engineering Technicians (NICET) guidelines.

### ***III.5 Important Differences in Minimum Sprinkler Requirements***

For purposes of compliance with Public Law 102-522, the least restrictive requirements for a particular HUD property category should be considered adequate. And, in most cases, the least restrictive requirements will provide design options that can be used by the designer/installer to reduce the cost of the system. In many cases these cost savings are significant without any measurable reduction in safety.

Requirements for the installation and maintenance of automatic sprinkler systems are extensive, regardless of which standard(s) are applied. Generally, it is appropriate to obtain the services of qualified design professionals and licensed sprinkler installers/contractors to design and install a fire sprinkler system and obtain the necessary approvals to insure system operability and reliability. However, there are basic minimum requirements that vary somewhat, depending on which standards govern the design and installation of the sprinkler system. These variations are potentially important in terms of system performance and system cost. The following is a detailed discussion of the minimum requirements in NFPA 13, 13R and 101, Chapter 19 for key system elements such as water supply, sprinkler types, and locations that can be exempted from sprinkler coverage. While some redundancy with Part II can be found here in Part III, the user will find review of this part to be easier in the absence of repeated references back to Part II. An abbreviated summary of the minimum requirements is presented in Table III.2 at the end of this section for quick reference.

#### **III.5.1 NFPA 13 Installation of Sprinkler Systems (1994 ed)**

Water Supply: At least one acceptable automatic water supply is required, as defined in NFPA 13. Typical acceptable water supplies include public water systems, elevated storage tanks, pressure tanks, and stored water sources with automatic pumps.

System Types: NFPA 13 recognizes several types of automatic sprinkler systems, including (1) wet pipe, (2) dry pipe, (3) preaction and deluge, (4) combined dry pipe and preaction, and (5) antifreeze systems. All of these types of systems are suitable for use in multifamily

residential buildings, but each system type requires unique specifications, components and design requirements.

**Advisory:** *Whenever possible, a wet pipe system is preferred. Dry pipe or antifreeze systems can be used in areas where freezing is possible, but require special design and installation considerations.*

**Advisory:** *The use of antifreeze systems may require additional valves and backflow prevention to insure that the antifreeze does not flow back into the public water system. The local water authority may prohibit the use of antifreeze, or require special treatment of such systems.*

**Advisory:** *If sprinkler piping is installed above a ceiling in an unheated attic space, specific installation practices must be maintained for both the sprinkler piping and attic insulation. Figure II.7 in Part II provides illustrations of how to install sprinkler piping and attic insulation to prevent freezing, a significant problem in many areas.*

**Sprinkler Types:** Listed standard sprinklers are acceptable throughout the building. Residential sprinklers are permitted inside dwelling units and in adjoining corridors.

**Advisory:** *The use of residential or quick response sprinklers are preferred throughout the building. These types of sprinklers have been demonstrated to provide improved life safety while maintaining the property protection normally associated with automatic sprinkler systems.*

**Piping:** Piping for use in an NFPA 13 system must be listed for such applications. Common types of sprinkler piping include steel, copper, and specific types of plastic (i.e., polybutylene (PB) and chlorinated polyvinyl chloride (CPVC)). The minimum pipe diameter permitted for sprinkler piping is nominally 3/4 inches.

All piping, valves, meters, etc. connecting the sprinkler system to the water supply must be listed (i.e., tested and certified by a nationally recognized organization acceptable to the local authority such as Underwriters Laboratories, Inc.). Combined domestic and automatic sprinkler supply piping is not permitted.

**Advisory:** *Problems have occurred in the use of plastic pipe as a result of joining methods that resulted in moderate to long term leakage. It is important to insure that the joining techniques used are part of the listing of the pipe system and meet appropriate provisions of ASTM standards for pipe systems for fire protection service.*

**Advisory:** *The use of small diameter pipe (i.e., less than 3/4 inch) is under investigation and may be permitted on a limited basis. However, it should not be permitted unless the design professional or the installation contractor can demonstrate*

*that NFPA 13 has been changed to permit the smaller diameter pipe, and that the smaller diameter pipe is listed for such service.*

**Advisory:** *Sprinkler piping can be degraded rapidly due to chemical or microbial induced corrosion. Local water quality should be tested to insure that such effects will be minimal. In some cases such effects may be reduced through the use of non-metallic piping (e.g., plastic) which does not react to most corrosive processes.*

**Required Coverage:** The standard requires that a building be fully sprinklered. Coverage areas include habitable spaces (i.e., dwellings and common areas), concealed spaces, vertical shafts, stairways, building service chutes, elevator hoistways and machine rooms, electrical equipment rooms, and so forth.

**Advisory:** *Under Option 3 of NFPA 101, Chapter 19, for rebuilt multifamily residential buildings, partial sprinkler systems can be used to help relax other building construction requirements. While NFPA 13 does not recognize partial sprinkler systems as an acceptable sprinkler design alternative, the requirements in NFPA 13 must still be met if a partial system is installed.*

**Exempted Coverage Areas:** The only areas exempted from sprinkler coverage under NFPA 13 are within the individual dwelling units. Exempted areas include:

- (a) bathrooms no greater than 55 sq. ft. in area with walls and ceilings of noncombustible or limited combustible construction having a 15 minute thermal barrier. A typical material that meets these requirements is painted or vinyl covered drywall.
- (b) clothes closets, linen closets and pantries no greater than 24 sq. ft. in area and with the smaller dimension (i.e., width or length) not exceeding 3 feet, and walls and ceilings of noncombustible or limited combustible materials.

**Hydraulic Design:** Normally the water flow rate and pressure are determined hydraulically, based on the area/density method provided in NFPA 13. Hose stream requirements must be added to the water demand determined independently for the sprinkler system. An exception permits calculation of the water demand inside individual dwelling units based on the four sprinkler maximum demand method permitted in NFPA 13R. A flow duration of thirty minutes is required.

**Advisory:** *The area/density method, if applied to the common areas or other spaces outside the dwelling unit, will frequently dominate the water flow demand requirement. The resulting demand may be considerably higher than for a sprinkler system designed for the same building under NFPA 13R. Therefore, whenever possible, consideration should be given to application of the requirements in NFPA 13R if the building height and the HUD property category permit its use.*

Alarm/Supervision: Local water flow alarm is required on all sprinkler systems having greater than 20 sprinklers. Electrical supervision of water flow valves is also required, with connection to the alarm system if one is provided.

***Advisory:** Normally it is good practice to at least require local water flow alarm for any installed sprinkler system, including partial systems of only a few sprinklers installed to protect specified areas under NFPA 101, Chapter 19, Option 3. Such practice reduces the possibility of extensive water damage due to system leakage or accidental sprinkler discharge.*

Seismic Protection: Seismic protection is required for sprinkler piping in areas subject to earthquakes. Guidance is provided regarding what geographical areas are included as well as various techniques for providing such protection.

Plans and Calculations: Detailed working plans and supporting calculations are required to be submitted to the local approval authority for approval prior to installation. Instructions regarding the general requirements and layout of sprinkler drawings/plans are provided in NFPA 13 (Chapter 6).

Approval/Acceptance Testing: Installation contractors are required to schedule and perform acceptance tests on all new or modified sprinkler systems. Contractors must prepare and sign Contractor's Material and Test Certificates (examples provided in Appendix A). Acceptance testing includes: (1) flushing of underground piping, (2) hydrostatic testing of the sprinkler system, (3) valve operation tests, (4) water flow tests, and other related tests.

Maintenance: A scheduled maintenance program should be set up by the property owner in accordance with NFPA 25, Standard for the Inspection, Testing and Maintenance of Water-Based Fire Protection Systems. Typical schedules and forms for maintenance are provided in Appendix A.

### **III.5.2 NFPA 13R, Sprinkler Systems in Residential Occupancies Up To and Including Four Stories in Height (1994 ed)**

Water Supply: At least one automatic water supply is required, as defined in NFPA 13R. Typical acceptable water supplies include public water systems, elevated storage tanks, pressure tanks, and stored water sources with automatic pumps.

Only a limited number of valves and hardware are required to be listed.

Common supply piping to the building can be used to supply domestic and sprinkler systems where

- (a) the domestic demand is added to the sprinkler system demand for purposes of determining the amount of water needed, or

- (b) water flow to the domestic system is automatically interrupted in the event of sprinkler system operation.

**Advisory:** *Where common supply piping is used, it is preferable to design the supply main so that the sprinkler system can not be isolated from the domestic system and shut off. A typical arrangement is illustrated in Figure II.6 in Part II. Exceptions are provided for systems that are supervised or for valves that are locked open. These precautions are necessary to insure system reliability.*

**Advisory:** *The use of common supply piping may require backflow prevention in order to assure that the sprinkler system water can not flow back into the domestic system or the public water supply. Requirements are normally determined by the local water authority.*

**System Types:** The most common types of sprinkler systems recognized in NFPA 13R are wet and dry pipe systems. As the terms suggest, wet pipe systems have water in the piping at all times, while dry pipe systems do not. Wet pipe systems are preferred for residential applications since there are no delays associated with water reaching the sprinkler heads, and should be installed in all areas not subject to freezing.

If areas are subject to freezing, piping can be protected through the use of antifreeze or by use of a dry pipe system. Both of these approaches require special considerations, and equipment and hardware listed specifically for such use, and the designs must comply with additional provisions of NFPA 13. Alternatively, sprinkler systems can be designed to avoid installation of piping in exterior walls where freezing may occur; piping installed in attic spaces can be installed along with the attic insulation so that freezing will not occur.

**Advisory:** *Whenever possible, a wet pipe system is preferred. The use of antifreeze may require additional equipment to prevent contamination of a public water supply. In some cases, the local water authority may even prohibit the use of antifreeze.*

**Advisory:** *While not required, it is a good practice in areas subject to freezing to install sprinkler piping in interior walls. In addition, as illustrated in Figure II.7 (Part II) insulation manufacturers frequently provide guidance on pipe installation in attics subject to freezing.*

**Sprinkler Types:** Listed residential sprinkler heads are required to be used inside all dwelling units. They are also permitted in corridors and lobbies adjacent to dwelling units provided these common spaces have maximum ceiling heights of ten feet or less, and the ceilings are smooth and flat.

Standard or quick response sprinkler heads are to be used outside the dwelling units for all other applications.



**Advisory:** *Except where the hazard requires special consideration, residential sprinkler heads should be used wherever possible. This type of sprinkler has been developed to provide unique life safety performance under residential type fires. Residential or quick response sprinklers should be used in common areas such as corridors, lobbies and basement utility areas.*

**Piping:** Piping for use in an NFPA 13R system must be listed for such applications. Common types of sprinkler piping include steel, copper, and specific types of plastic (i.e., polybutylene (PB) and chlorinated polyvinyl chloride (CPVC)).

**Advisory:** *Problems have occurred in the use of plastic pipe, primarily as a result of joining techniques that resulted in moderate to long term leakage. It is important to insure that the joining techniques used are part of the listing of the pipe system and meet appropriate provisions of ASTM standards for pipe systems for fire protection service.*

**Advisory:** *Sprinkler piping can be degraded rapidly due to chemical or microbial induced corrosion. Local water quality should be tested to insure that such effects will be minimal. Where possible, such effects may be reduced by the use of non-metallic piping (e.g., plastic) listed for such application.*

**Required Coverage:** The standard requires that a building be fully sprinklered. There are no exceptions for partial sprinkler systems designed to protect isolated areas.

**Exempted Coverage Areas:** Certain areas are exempted from sprinkler coverage, even though NFPA 13R generally assumes that the entire building will be sprinklered. The exempted areas include the following:

- (a) bathrooms no greater than 55 sq. ft. in area with walls and ceilings of noncombustible or limited combustible construction having a 15 minute thermal barrier. A typical material that meets these requirements is drywall, painted or vinyl finished.
- (b) clothes closets, linen closets and pantries within the dwelling units no greater than 24 sq. ft. in area and with the smaller dimension (i.e., the width or the length) not exceeding 3 ft, and walls and ceilings of noncombustible or limited combustible materials.
- (c) porches, balconies, corridors and open and attached stairs.
- (d) attics, penthouse equipment rooms, crawl spaces, floor-ceiling spaces, elevator shafts, and other concealed spaces not used for living or storage.

**Hydraulic Design:** The sprinkler systems in the individual dwelling units are required to supply sufficient water pressure and flow to accommodate up to as many as four sprinklers at one time. Outside the dwelling units, the demand is to be calculated by the area/density method

outlined in NFPA 13, which could result in a considerably higher water demand. The required flow duration for systems designed under NFPA 13R is 30 minutes. That is, the water supply must be able to accommodate the required flow rate and the pressure for 30 minutes.

*Advisory: There are exceptions in NFPA 13R that permit the use of the four sprinkler maximum outside the dwelling units, depending on the size of the floor areas and the ceiling height of the spaces to be protected. In general, the use of the four sprinkler maximum can result in a lower water supply demand than would be expected under the area/density method. In many areas the public water system can supply the water demand for the four sprinkler maximum design without pumps or other hardware that adds considerable cost to the basic system costs.*

Alarm/Supervision: Local water flow alarm is required on all sprinkler systems having greater than 20 sprinklers. Electrical supervision of water flow valves is also required, with connection to the alarm system if one is provided.

*Advisory: Normally it is good practice to at least require local water flow alarm for any installed sprinkler system, including partial systems of only a few sprinklers installed to protect specified areas under NFPA 101, Chapter 19, Option 3. Such practice reduces the possibility of extensive water damage due to system leakage or accidental sprinkler discharge.*

Seismic Protection: Seismic protection is required for sprinkler piping in areas subject to earthquakes. Guidance is provided in NFPA 13 regarding what geographical areas are included as well as various techniques for providing such protection. NFPA 13R refers to NFPA 13 for seismic requirements.

Plans and Calculations: Detailed working plans and supporting calculations are required to be submitted to the local approval authority for approval prior to installation. Instructions regarding the general requirements and layout of sprinkler drawings/plans are provided in NFPA 13R (Chapter 2).

Approval/Acceptance Testing: Installation contractors are required to schedule and perform acceptance tests on all new or modified sprinkler systems. Contractors must prepare and sign Contractor's Material and Test Certificates (examples provided in Appendix A). Acceptance testing includes (1) flushing of underground piping, (2) hydrostatic testing of the sprinkler system, (3) valve operation tests, (4) water flow tests, and other related tests.

Maintenance: A scheduled maintenance program should be set up by the property owner in accordance with NFPA 25, Standard for the Inspection, Testing and Maintenance of Water-Based Fire Protection Systems. Typical schedules and forms for maintenance are provided in Appendix A.

### III.5.3 NFPA 101 Life Safety Code, Chapter 19 (1994 ed)

The requirements in Chapter 19 of the NFPA 101 Life Safety Code apply only to HUD property category II - rebuilt multifamily properties of four or more stories in height. Under Chapter 19, an existing building must fully meet the requirements of one of four options. Options 3 and 4 involve the use of automatic sprinkler systems.

Option 3 (applicable to buildings of 4 to 6 stories) permits partial sprinkler systems installed to protect hazardous areas and common path corridors. Option 4 (applicable to buildings greater than six stories) requires complete sprinkler coverage throughout the building. Generally, where Option 3 or 4 is adopted, other fire safety requirements such as interior finish flame spread, travel distances, and fire resistance of walls, ceilings, and doors are relaxed.

#### **Option 3 - Partial Sprinkler Systems**

**Applicable Sprinkler Requirements:** For properties of four or five stories the installation requirements in NFPA 13R should be applied. For properties of six stories or higher, NFPA 13 is the applicable installation standard.

**Sprinkler Types:** The use of residential or quick response sprinklers in dwelling units is recommended.

**Required Coverage:** Sprinklers are required in the corridors outside dwelling units. In addition, one sprinkler is required inside each dwelling unit at the exit door unless the exit door has a fire resistance rating of at least 20 minutes and is provided with an automatic closer device.

Sprinklers may be used as a substitute for more stringent fire resistant construction in common hazardous areas such as utility rooms, laundries, storage areas, etc.

**Exempted Areas:** N/A

**Hydraulic Design:** The design area and water demand are determined in accordance with NFPA 13 and the listing of the sprinkler.

**Alarm/Supervision:** per NFPA 13

***Advisory:*** *The use of Option 3 in existing 4, 5 or 6 story properties may in some cases permit significant reductions in fire resistance requirements, egress requirements, travel distances, etc. This option may permit cost effective fire protection upgrades where otherwise the construction costs to comply with Chapter 19 would be prohibitive. It should also be noted that in certain cases it will be more economical to add fire rated partitions and increase the fire resistance of selected walls, ceilings and doors than to install partial*

*sprinkler systems. Qualified fire protection engineering firms should be selected to assist in selection of the most cost effective approach.*

#### **Option 4 - Complete Retrofit Sprinkler Systems**

**Applicable Sprinkler Requirements:** Option 4 applies to buildings over six stories in height. Therefore, the requirements in NFPA 13 apply.

**Sprinkler Types:** Residential or quick response sprinklers are recommended for use in the individual dwelling units. The requirements of NFPA 13 apply regarding the selection of sprinklers for the areas outside the dwelling units, but residential or quick response sprinklers are also encouraged for use in these areas.

**Required Coverage:** Option 4 requires complete sprinkler coverage throughout the building, per NFPA 13.

**Exempted Areas:** Sprinklers may be omitted in bathrooms and closets inside dwelling units. Limitations regarding combustibility of interior finish and the size of the areas are the same as those for NFPA 13.

**Hydraulic Design:** The design area and water demand are determined in accordance with NFPA 13 using the area/density method or the small room method, depending on which applies.

**Alarm/Supervision:** A local water flow alarm is required which must also operate the building fire alarm system if one is provided. When tied to the building fire alarm system, remote transmission of sprinkler operation as well as a fire alarm is recommended in order to provide quick notification to the fire department.

***Advisory:*** *Major tradeoffs in construction are permitted in terms of fire resistance, travel distances, number of exits, and protection of vertical openings when Option 4 is used. As with Option 3, a qualified fire protection engineering firm should be selected to assist in determining the most cost effective approach.*

Table III.2 Summary of Minimum Requirements for Automatic Sprinklers

Feature	NFPA 13	NFPA 13R	NFPA 101, Ch 19
Water Supply	At least one acceptable supply, i.e., public water, elevated storage, pressure tanks, stored water with automatic pumps; all components must be listed.	<ul style="list-style-type: none"> <li>• At least one acceptable supply.</li> <li>• Common domestic and sprinkler supply permitted</li> <li>• Only selected components must be listed</li> </ul>	Refers to NFPA 13
System Types	Wet, dry, preaction and deluge, combined dry and preaction, antifreeze	<ul style="list-style-type: none"> <li>• Same as NFPA 13</li> <li>• Wet system preferred for life safety</li> <li>• Caution for freezing</li> </ul>	Refers to NFPA 13
Sprinkler Types	“Listed” standard sprinklers throughout building; residential sprinklers permitted in dwelling units and adjoining corridors	<ul style="list-style-type: none"> <li>• Listed residential sprinklers in dwelling units, corridors, and lobbies (restrictions apply)</li> <li>• Standard or quick response in rest of building</li> </ul>	Residential or quick response in dwelling units
Piping	<ul style="list-style-type: none"> <li>• Steel, copper, polybutylene, CPVC</li> <li>• Minimum diameter = 0.75 in. (3/4 in.)</li> <li>• All components must be “listed” for application</li> </ul>	Same as NFPA 13	Refers to NFPA 13
Required Coverage	Total coverage, including concealed spaces, stairways, and mechanical enclosures	Total coverage	<p><u>Option 3:</u> Partial systems</p> <ul style="list-style-type: none"> <li>• Sprinklers in corridors with one sprinkler inside each dwelling unit above exit door (restrictions apply)</li> <li>• Substitute for fire resistance in utility, laundry and storage areas</li> </ul> <p><u>Option 4:</u> Complete retrofit</p> <ul style="list-style-type: none"> <li>• Total coverage</li> </ul>

Feature	NFPA 13	NFPA 13R	NFPA 101, Ch 19
Exempted Areas	Bathrooms <55 ft <sup>2</sup> with noncombustible or limited combustible walls and ceilings Clothes closets, linen closets, pantries ≤24 ft <sup>3</sup> in area with non or limited combustible walls and ceiling	Bathrooms (same as NFPA 13)  Same as NFPA 13 Porches, balconies, corridors, open/attached stairs, attics, penthouses, crawl spaces, etc.	<u>Option 3:</u> Partial systems Not applicable <u>Option 4:</u> Complete retrofit Bathrooms and closets per NFPA 13
Hydraulic Design	Area/density method	Inside dwelling units: maximum up to 4 sprinklers;  Outside dwelling units: area/density method	Area/density method per NFPA 13
Alarm/Supervision	Local water flow for > 20 sprinklers Supervision of water flow valve with connection to alarm system if one is provided	Same as NFPA 13  Same as NFPA 13	Same as NFPA 13
Seismic	Required in areas subject to earthquake	Same as NFPA 13	No reference (covered by NFPA 13)
Plans and Calculations	Must be submitted to local AHJ for approval prior to installation	Same as NFPA 13	No reference (covered by NFPA 13)
Approval/Acceptance Testing	Installation contractor must schedule conduct and document series of test	Same as NFPA 13	No reference (covered by NFPA 13)
Maintenance	Scheduled maintenance program should be setup by building owner per NFPA 25	Same as NFPA 13	No reference (covered by NFPA 13)

### ***III.6 Demonstrating an Equivalent Level of Safety to Sprinklers***

The General Services Administration has developed requirements for the engineering analysis which can be used to demonstrate that arrangements or systems provide a level of life safety for building occupants equivalent to that provided by sprinkler systems. These requirements are included as Appendix B of this guide, and are summarized in this section.

There are three endpoint criteria necessary to demonstrate an equivalent level of safety to sprinklers. First, the housing unit must be designed, constructed, and maintained to prevent flashover (defined as an upper layer temperature of 600 °C, 1100 °F; or a heat flux of 20 kW/m<sup>2</sup>, 1.8 Btu/ft<sup>2</sup>/sec) in the room of fire origin. Second, to limit the fire size to no more than 1 MW (950 Btu/sec), and third, to prevent flames from leaving the room of fire origin. These criteria must be met under the worst case fire scenarios identified.

The analysis must be performed by a qualified fire protection engineer, defined as the holder of a degree in fire protection or firesafety engineering and four (4) years of professional experience or a licensed Professional Engineer registered in fire protection or in a related discipline and holding the grade of Member in the Society of Fire Protection Engineers. Determination of acceptability is the responsibility of the head of the agency responsible for providing Federal assistance or his designated representative.

## IV. REFERENCES

Public Law 102-522, Fire Administration Authorization Act of 1992

NFPA 13, Installation of Sprinkler Systems (1994 ed)

NFPA 13R, Sprinkler Systems in Residential Occupancies Up to and Including Four Stories in Height (1994 ed)

NFPA 13D, Sprinkler Systems in One- and Two-Family Dwellings and Manufactured Homes (1994 ed)

NFPA 25, Water-Based Fire Protection Systems (1992 ed)

NFPA 70, National Electrical Code (1993 ed)

NFPA 72, National Fire Alarm Code (1993 ed)

NFPA 74, Household Fire Warning Equipment (succeeded by NFPA 72)

NFPA 101, Life Safety Code, Chapter 19 (1994 ed)

NFPA 220, Standard on Types of Building Construction (1992 ed)

The forms which follow are reprinted with permission from *Fire Protection Systems, Second Edition*, Copyright ©1993, National Fire Protection Association, Quincy, MA 02269.