

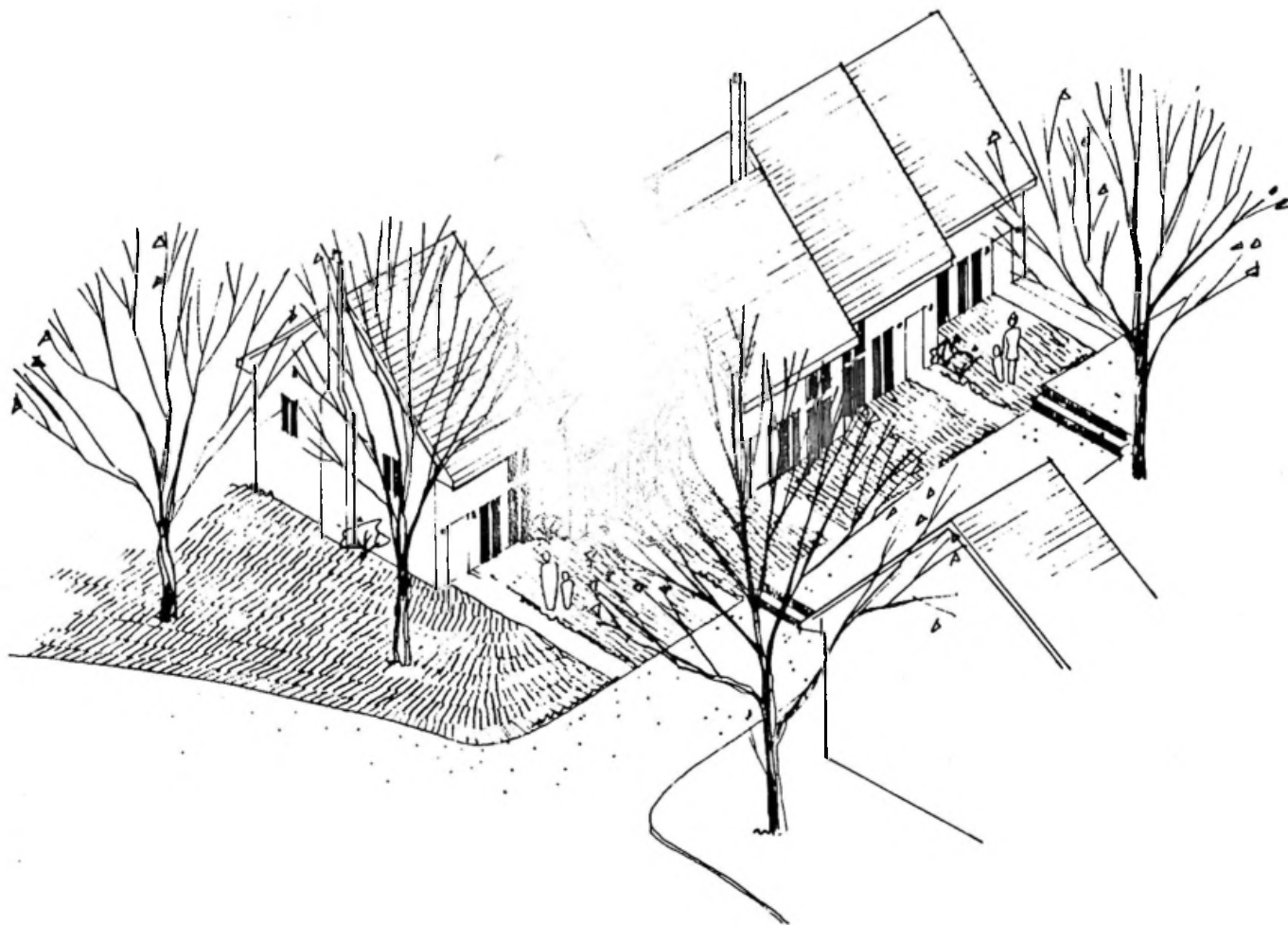

Affordable HOUSING



**Development Guidelines for
State and Local Government**

**AFFORDABLE HOUSING DEVELOPMENT GUIDELINES
FOR STATE AND LOCAL GOVERNMENT**

Prepared for

**U.S. Department of Housing
and Urban Development
Office of Policy Development and Research
Innovative Technology Division**

Contract HC-5789

to

**Dewberry & Davis
Fairfax, VA**

by

**NAHB National Research Center
Upper Marlboro, MD**

November 1991

TABLE OF CONTENTS

Preface	i
Acknowledgments	iii
Chapter One: Introduction	1
What is Affordable Housing	1
What Can This Manual Do?	2
Chapter Two: Development Approval Processing	5
Introduction	5
Evaluating the Current System	5
Revamping the Current System	6
Creating a Reasonable Development Approval Process	7
Preapplication Stage	7
Application Stage	10
Staff Review Stage	11
Public Hearing Stage	13
Other Issues	14
Neighborhood Meetings	15
Improving Intergovernmental Coordination	15
Chapter Three: Land Use	17
Introduction	17
Increasing Buildable Land Supply	18
Zoning, Density, and Lot Size	19
Small-Lot Districts	21
Setback Requirements	23
Environmental and Topographic Constraints	26
Land/Price Ratios	26
Planned Unit Development	28
Ancillary Apartments	28
Site Planning	28

The work that provided the basis of this publication was supported by funding under a contract with the U.S. Department of Housing and Urban Development. The substance and findings of that work are dedicated to the public. The authors are solely responsible for the accuracy of the statements and interpretations contained in this publication. Such interpretations do not necessarily reflect the views of the Government.

	39
Chapter Four: Streets	39
Introduction	40
Principles of Residential Street Layout	43
Street Hierarchy Classification System	46
Access and Street Alignment	47
Vertical and Horizontal Alignments	47
Number of Lanes and Pavement Widths	50
Speed	51
Gradients	52
Cul-de-Sacs and T-Turnarounds	53
Loops	54
Alleys	55
Street Construction	55
Emergency Vehicles, Moving Vans,	55
Snow Plows, Garbage Trucks	56
Intersections	57
Curbs	58
Parking	58
On-Street Parking	59
Off-Street Parking	59
Parking Construction	60
Rights-of-Way	61
Easements	62
Chapter Five: Curbs and Gutters	65
Introduction	65
Swales	65
Types of Curbs	66
Gutters	67
Curbs in Off-Street Parking Areas	67
Construction Methods	68
Chapter Six: Sidewalks and Walkways	71
Introduction	71
Sidewalks in Residential Areas	71
Pathways and Walkways	71
Dimensions and Construction	73
	74

Chapter Seven: Storm Drainage Systems	77
Introduction	77
Design Storm Requirement	78
Detention/Retention	78
Overland Relief	79
Materials	80
Stormwater Structures	80
Manholes/Inlets	80
Inlet/Outlet Controls	83
Chapter Eight: Sanitary Sewers	85
Introduction	85
Manholes, Curvilinear Sewers, Cleanouts	85
Cleanouts	88
Drop Manholes	88
Pipe Materials	90
Design Criteria	91
Inspection	91
Common Laterals	92
Chapter Nine: Water Supply	95
Introduction	95
Water Mains	95
Water Service	96
Connections	96
Multiple Connections	96
Sizing	98
Accessory Items	101
Chapter Ten: Utilities And Utility Easements	103
Introduction	103
Easements	103
Materials	104
Installation	104

Chapter Eleven: Design	107
Introduction	107
Unit Orientation	108
Exterior Appearances	109
Unit Size	111
Interior Layout	111
Designing for Economy	113
Chapter Twelve: Construction And Building Codes	115
Introduction	115
Footings and Foundations	116
Footing Widths	117
Footing Reinforcement	119
Footing Depth	119
Basement Foundation Walls	120
Wood Floor Construction	125
Sill Plate	126
Floor Center Support Beam	126
Walls and Partitions	131
Roof Framing and Sheathing	139
Plumbing	140
Plumbing System Design	142
Drains and Vents	142
Water Service and Distribution	147
Water Heaters	150
Electrical	150
Heating, Ventilation, and Air Conditioning	151
Chapter Thirteen: Rehabilitation	157
Introduction	157
Acquiring Property for Rehabilitation	157
Economic Analysis	158
Single Room Occupancy	159
Bibliograph	163

PREFACE

At the forefront of the several important issues affecting the nation is a need for affordable housing. Good, safe, sanitary housing is essential to a decent life and central to the well-being of the nation. Widespread homeownership benefits society as a whole by strengthening household ties to the community and providing opportunities for investment in the nation's future. In recognition of the important role of homeownership, U.S. Department of Housing and Urban Development Secretary Jack Kemp has identified "expanding homeownership and affordable housing opportunities" as one of his top priorities.

The delivery of affordable housing is a complex activity that involves the support of many parties and the coordination of their activities and efforts. A key problem has been the proliferation of excessive or unnecessary regulations and standards that stifle the ability of the housing market to provide affordable Housing. In March 1990 Secretary Kemp, at the request of the President, established the Advisory Commission on Regulatory Barriers to Affordable Housing. The Commission was asked to identify regulatory barriers to affordable housing and recommend how these barriers could be removed. The Commission's report, "Not in My Back Yard"- Removing Barriers to Affordable Housing was submitted to President Bush and Secretary Kemp in July, 1991.

The Commission report presents a bold and comprehensive plan for Federal, State, local and private action for regulatory reform. The Commission proposed, as part of its 31 recommendations, that the U.S. Department of Housing and Urban Development provide expanded technical guidance and information to State and local governments that are seeking to reform their regulatory systems.

A rapidly expanding body of knowledge on regulatory reform has been accumulating in cities and communities throughout the United States. Some of the information has come from U.S. Department of Housing and Urban Development-sponsored programs, while much has also been generated by grassroots civic organizations, local public officials, nonprofit groups, builders, and consumers who want to buy affordable homes. Much of this important and valuable information has been gathered into this volume. It is intended as a handbook for local governments that want to join the effort to reaffirm the American Dream of a good home in a good neighborhood for every family in America.

Acknowledgments

This manual was prepared for the U.S. Department of Housing and Urban Development by the NAHB National Research Center under contract to Dewberry and Davis. The work was directed by the Office of Policy Development and Research.

The principal author was E. Lee Fisher, with writing and editing assistance from Carol E. Soble and design and production assistance from Jane J. Willeboordse and Victoria A. Klobe. James Murphy, Senior Associate of Dewberry and Davis, provided project oversight.

INTRODUCTION

For millions of American families, the dream of a home remains just that--a dream. Many factors are at work denying housing opportunity and choice. For the very low-income, the root cause is poverty. Aspects of both the financing and tax systems are also major factors in the affordability squeeze. Another significant factor contributing to that squeeze is excessive, exclusionary or unnecessary State and local regulations, standards and development controls. These regulations not only restrict the ability of the private market from meeting the demand for affordable housing but also limit the efficacy of government housing assistance and subsidy programs.

What is Affordable Housing?

The term "affordable housing" means different things to different people. The Advisory Commission on Regulatory Barriers to Affordable Housing stated the issue most clearly, "What does it mean if there is not enough affordable housing? Most urgently, it means that a low- or moderate-income family cannot afford to rent or buy a decent-quality dwelling without spending more than 30 percent of its income for shelter, so much that it cannot afford other necessities of life. With respect to renters, the Commission is particularly concerned with those with incomes below 50 percent of the area median income. In other cases, it also means that a moderate-income family cannot afford to buy a modest home of its own because it cannot come up with the downpayment, or make monthly mortgage payments, without spending more than 30 percent of its income on housing."

Introduction

What Can This Manual Do?

Intended for use by local governments that have determined affordable housing is a priority, this manual outlines a set of development practices that can assist in the delivery of affordable housing. It focuses on land development techniques, construction practices and building codes, zoning provisions, and subdivision requirements and offers suggested ordinances and code language that can help modernize a community's existing regulations and ensure the cost-effective production of safe, decent housing. Suggested code and ordinance language is enclosed in double-lined boxes and printed in italics.

The suggested code and ordinance language reflects some of today's most important research-based advances in both land development and construction techniques. In most cases, these advances have found successful application in various communities across the country under the JVAH program and have proven that a system of modernized regulations enhances rather than compromises the neighborhoods that American families call home. In short, an important part of the solution to the need for affordable housing lies in regulatory reform.

For nearly a decade, the U.S. Department of Housing and Urban Development with the assistance of the NAHB National Research Center have been investigating and promoting solutions to the problem of increasing housing costs. This manual, reflecting ten years' worth of theoretical and practical experience, represents the best efforts of researchers, community planners, and elected officials to address the housing affordability issue.

This volume contains a compilation of proven cost-reduction measures applicable to development approval processing, land planning and development, and construction techniques. It builds on the earlier successes of the U.S. Department of

Housing Development's Joint Venture for Affordable Housing (JVAH). Methods used in the original JVAH demonstration program are chronicled in two earlier HUD publications: **Challenge and Response, Volume I - Affordable Residential Land Development;** and, **Challenge and Response, Volume II - Affordable Construction Techniques.**

1870
The first of the year
was a very dry one
and the crops were
very poor. The
winter was also
very cold and
the snow was
very deep.

DEVELOPMENT APPROVAL PROCESSING

Introduction

The multiplicity of local regulations that govern the development and/or rehabilitation of individual homes and entire neighborhoods is usually administered by a host of government agencies and departments, each of which operates on its own timetable and brings its own particular perspective, statutory responsibilities, and concerns to the residential development process. With today's expanding array and reach of development regulations, the development approval process now plays a significant role in the timely and efficient delivery of affordable housing.

It is obvious that rational and efficient administration of development regulations is an essential complement to any affordable housing effort. The development approval process must be "systematized" so that it operates predictably, reasonably, efficiently, and rapidly while still protecting the community's health, welfare, and safety. An important step that municipalities can take to promote affordable housing is to review the entire regulatory process from zoning through permitting as it is experienced by developers and thereby identify procedures that can be simplified, abbreviated, or approved.

Evaluating the Current System

The system as it now exists can offer insights into the effectiveness of its operations. *The National League of Cities*¹ recommends that the following kinds of factors should be evaluated:

- length of the process from application submission to approval or issuance of permit
- number of separate permits, approvals, hearings, and administrative reviews necessary for construction and occupancy of a dwelling

¹ National League of Cities, "Streamlining the Local Development Process," in *Housing Supply and Affordability*, Urban Land Institute, 1983.

Development Approval Processing

- number of separate agencies, departments, boards, and other groups that must review the application
- types and detail of information, including special plans and designs required for various approvals

In addition, a couple of inquiries into the operation of the system can yield information on backlogs, snags, and time elapsed for typical project approval. For example, it might be useful to undertake a comparison of time required for processing today versus five or 10 years ago. The length of the process can be determined by documenting dates of application submission and the dates of development approval. A more detailed look into the process would involve an investigation into the time consumed by individual agencies, departments, boards, etc., in making their respective determination on a proposed project. Patterns of time delays might signal snags that can be untangled through redesign of the process.

Revamping the Current System

Any attempt at revamping the current system should reflect the following guidelines:

- provide plain and concise information about requirements and procedures
- allow ready access to key personnel who will make initial findings and decisions
- establish a cooperative and coordinated review process that is geared to solving problems and issues, not to creating them
- make rapid reviews and prompt decisions
- provide a well-defined appeals process

The success of redesigning the system is dependent not only on the above considerations but on the process by which change is achieved. The reform effort can be carried out by government staff, consultants, a specially convened task force or commission, or some combination of these actors who have credibility with the overall community. For the following reasons, a working group of public officials, builders and developers, representatives of community groups, and consultants is especially appropriate to review and make recommendations on the development approval process:

- it gives the task the status of a communitywide effort in which diverse interests and views are presented
- it helps consolidate community support for the recommendations and the actions needed to implement them
- it helps broaden awareness and understanding of affordable housing and of the municipality's support of it

In any event, it is important to recognize that any reform effort must balance the sometimes conflicting goals and needs of elected officials, regulators, developers and builders, citizen interest groups, affordable housing advocates, and others. A reworked development approval system must allow for both predictability and flexibility, all the while ensuring efficiency, fairness, and effectiveness. Further, a redesigned system must lend itself to easy implementation, politically, legally, and practically speaking.

Creating a Reasonable Development Approval Process

The following discussion breaks down the approval process into its component stages: preapplication, application, staff review, public hearings, and final decision. It looks at how localities can expedite and improve each of the basic stages by streamlining procedures.

Preapplication Stage

The process of residential development is anything but straightforward. Developers recognize that their concepts and plans must undergo a series of adjustments and revisions if a development proposal is to comply with local regulations, satisfy citizen concerns, and remain marketable given the development schedule and local economic conditions. And these revisions can consume substantial time and money. For their part, regulators are obligated to protect the public trust and to ensure that a development proposal does not compromise the public health, safety, and welfare.

To minimize risk all around, both developers and local regulators in many communities are finding it useful to engage in **preapplication conferences** before the developer's

Development Approval Processing

formal submission of an application. Such meetings provide developers with the opportunity to explore the feasibility of a proposal without undertaking expensive engineering and architectural work. Local regulators explain the steps that must precede approval; the probable receptiveness of government staff, elected officials, and the general public to the proposal; and any pending public actions that might affect the developer's plans. The information shared at the meeting enables the developer to work from an informed position and to make a decision to commit time and money to the development if the chances for success appear reasonable. In short, a preapplication conference should dramatically limit the number of trips back to the drawing board.

Suggested Ordinance Language

Preapplication Conference: (a) At the request of the applicant, the planning commission shall authorize a preapplication conference. (b) The preapplication conference shall allow the applicant to meet with appropriate municipal representatives. These individuals, who shall be designated by the [mayor and/or governing body/planning commission/other] may include: the municipal engineer; the municipal planner; the municipal building code official; the municipal zoning official; a representative from the planning commission and/or board of adjustment; representatives from environmental, historic preservation, and other commissions as deemed appropriate; and/or any other representatives invited by the planning commission chairperson. (c) Applicants seeking a preapplication conference shall submit the information stipulated in [Appropriate Ordinance Article] 10 days prior to the preapplication conference. (d) If requested and paid for by the applicant, a brief written summary of the preapplication conference shall be provided within 10 working days of the final meeting. (e) The applicant may be charged a reasonable fee for a preapplication conference. (f) The applicant shall not be bound by the determination of the preapplication conference, nor shall the planning commission or subdivision and site plan committee be bound by any such review.

Source: *The Subdivision and Site Plan Handbook*, Listokin and Walker, Rutgers, The State University of New Jersey, 1989.

As an adjunct to the preapplication conference, printed information targeted to the developer or interested citizen should be available for distribution. The information should respond to the needs of both experienced developers and newcomers and include the following:

- lists of permits required for every type of regulation, with summaries of information needed for each
- explanations of procedures, along with official time periods or deadlines and estimates of processing time
- schedules of fees for all permits
- complete copies of ordinances and regulations
- an explanation of appeal procedures
- checklists of guidelines and criteria used by staff in the review process, which may be collected in a guidebook or manual
- general information on the local government, including its organization and key personnel, with names and telephone numbers

The ready availability of such material can reduce the staff time needed to explain the approval process. To remain useful, the material must be updated as ordinances, policies, and procedures are amended or revised.

In addition to printed materials, a centralized information function can be a useful resource for both developer and the general public's inquiries into the development process. It can serve as a clearinghouse for the several departments that play a role in the approval process. The centralized information function can take one of several forms, including

- a central telephone point where calls can be routed for general information, if only to clarify the nature of the request and reroute it to the correct department
- a referral desk, stocked with written materials and staffed by employees who can answer general questions and refer others to the appropriate person
- an application center, where staff accept and assist with applications, answer questions, route applications and plans to the correct departments, and collect approved applications and issue the final permit

Development Approval Processing

- a central permit office, staffed by interdisciplinary teams drawn from individual departments, which is capable of accepting applications and issuing permits to all but the most complex projects

Whatever form it takes, the centralized information function must be staffed by personnel knowledgeable of the process and able to direct questions appropriately. Further, it is important to recognize that all of the centralized information arrangements are best suited to simple projects, not to complex projects that often require negotiations.

Application Stage

The redesign of the approval process provides an excellent opportunity to revise the application form itself to simplify application screening, focus review efforts, guide decisions makers, and streamline recordkeeping. In addition, all government agencies and departments with a role in the development process should coordinate their information requests to ensure that the application does not ask for duplicative data. As a general principle, the application should not ask developers for information that the community does not absolutely need. An atmosphere of cooperation will encourage applicants to seek early clarification of any points of confusion.

If developers do not secure the printed information made available at the preapplication stage, they should be able to obtain a full package of materials at the application stage. The package should include the following:

- an application form
- a directory or checklist of all required permits
- permit fee schedules
- information about departments and regulations
- copies of ordinances
- manuals, flow charts, or instruction sheets describing the steps necessary for approvals and their time frames

It is incumbent upon the applicants to provide all the information required by the application form. A complete and accurate application can prevent delay.

Suggested Ordinance Language

Complete Application: A subdivision and site plan application shall be complete for purposes of commencing the applicable time period for action when so certified by the [administrative officer/planning commission]. In the event such certification of the application is not made within 45 days of the date of its submission, the application shall be deemed complete upon the expiration of the 45-day period for purposes of commencing the applicable time period unless (1) the application lacks information indicated on the checklist of items to be submitted specified in [appropriate Ordinance Article] and provided in writing to the applicant, and (2) the [administrative officer/planning commission] has notified the applicant, in writing, of the deficiencies in the application within 45 days of submission of the applicant. The planning commission may subsequently require correction of any information found to be in error and submission of additional information not specified in the ordinance, as is reasonably necessary to make an informed decision. The application shall not be deemed incomplete for lack of any such additional information or any revisions in the accompanying documents so required by the planning commission.

Source: *The Subdivision and Site Plan Handbook*, Listokin and Walker, Rutgers, The State University of New Jersey, 1989.

Staff Review Stage

Once submitted for a rezoning, subdivision approval, building permit or other type of development approval, an application is subjected to direct review and evaluation by agency/department staff. Most of the time dedicated to staff review is, however, devoted to routing the application to the appropriate office, working through a backlog of applications, or resolving differences among staff or between staff and the developer. One or more of the following techniques can streamline the staff review stage:

- A combined or joint review committee can coordinate reviews by several agencies or departments through regular meetings of department/agency representatives. The committee should be composed of department heads or individuals authorized to make decisions so that the group itself can decide on applications. The effectiveness of a combined or joint review committee depends on earlier analysis completed by individual departments. The committee on its own, however, can

Development Approval Processing

reduce total processing time by setting realistic deadlines and, when one individual delays the entire process, by exerting peer pressure. Joint review committees can resolve disagreements more immediately than can departments/ agencies acting individually and can evaluate a project in its entirety rather than in separate pieces.

- With a system of concurrent reviews, the department responsible for granting development approvals receives a copy of the application at the same time that all other departments with a role in the approval process receive their copy of the application. Concurrent reviews tend to minimize delay, particularly if a single staff member or department is appointed to coordinate the entire operation.
- Fast-tracking noncontroversial or routine projects can shorten the approval process by eliminating public hearings, giving priority to applications needing the attention of only one or two departments, and, for some project types, clearing the way for administrative approval rather than commission or council action.
- Permit expeditors can guide development applications through the review process and serve as the developer's prime contact person. The permit expeditor can assist the preparation of the application and serve as a go-between during the review and approval stages. Usually, expeditors focus on commercial or industrial projects.
- Establishing realistic review deadlines can provide the staff with guidelines for performance and stimulate productivity, although such deadlines can rarely be enforced. Deadlines can, however, give the developer a rough estimate of the time required for staff review.
- Contracting out site plan reviews to consultants can help relieve backlogs in high-growth areas where the relevant departments and agencies are overburdened with project applications. Contracting out is also an efficient use of resources in communities where the level of development is too low to justify the

employment of a full-time planning staff. When developers have the option of specifying either in-house staff or consultant review of an application, they simply indicate their preference for an expedited review. They may, however, have to pay 20 percent to 30 percent more for the service but are ensured of professional decisions within a shorter time frame.

Public Hearing Stage

In most instances, local law requires development proposals to be placed before the general public for comment and reaction. The traditional forum for soliciting public response to a development proposal is the public hearing. Particularly for major developments, the approval process can extend for several months and may be complicated by a developer request for a rezoning or by the need for special review procedures related to subdivision design features or other considerations. Projects deemed controversial by the general public or special interests consume even more public hearing time as citizen activists make their positions--both pro and con--known.

Any of the following improvements to the hearing process can speed the entire development approval process:

- Streamlining hearing procedures can substantially compress the time required for a public hearing--even for complex projects. Rules for public hearings, embodied in either the relevant ordinances or in an officially adopted set of bylaws or procedural rules, may spell out how the proposal is to be presented, which staff response is required, and who is entitled to comment. If necessary, time limits can be imposed on speakers, or requirements can specify that each single speaker represent a single group.
- Combined multiple hearings before a joint hearing body can consolidate the often six or seven hearings required by some jurisdictions for subdivision applications that request a rezoning. Combined multiple hearings are especially appropriate for noncontroversial projects, although it is important to

Development Approval Processing

recognize that any project application may raise issues that might legitimately necessitate a hearing. As with combined or joint staff review, combined multiple hearings permit a fairer consideration of project applications by enabling all viewpoints to be considered and resolved simultaneously.

- Appointing hearing examiners to conduct hearings relieves elected or appointed officials of the responsibility to participate in hearings and introduces greater objectivity into the approval process. A hearing examiner conducts a hearing and submits a report and recommendation to the local legislative decision-making body. The examiner usually takes a balanced view of the merits and demerits of the proposal and introduces greater certainty and regularity into the conduct of the proceedings. Reliance on a hearing examiner is appropriate for either limited reviews of special exceptions, variances, and special permits or for major hearings on rezoning and subdivision applications.
- In some communities, replacing hearings with administrative decisions is appropriate when a large number of applications can justify screening out noncontroversial proposals. Under this arrangement, the local decision-making body can devote its time to focusing on policy issues and major projects.

Other Issues

Efforts to simplify and rationalize the development approval process can contribute significantly to speeding the production of needed affordable housing and can demonstrate local government's commitment to expanding housing options for its citizens. It is important to note, however, that even the best intentions of local governments to reform their approval mechanisms can be undermined by other variables sometimes beyond the control of local decision makers. Some of these issues are discussed below in an attempt to alert participants in the approval process to potential obstacles to the expeditious processing of development applications.

Neighborhood Meetings

Citizen interest groups, growing ever more sophisticated in the techniques and strategies of delaying project approvals, are making the prospect of affordable housing less and less of a reality in many communities. In prolonging the approval process, they effectively increase the developer's carrying costs to an extent that once-affordable housing is priced out of the affordable range.

Community decision makers must not only remain aware of citizen attempts to derail a needed project but must take the necessary steps to defuse opposition and create a greater, communitywide understanding of the need for affordable housing. One useful tactic is to hold neighborhood meetings well before scheduled public hearings. When project plans are unveiled for the first time at public hearings, several reactions can occur, most of them time-consuming. A neighborhood meeting, on the other hand, provides an opportunity to explain the purpose of a proposed project, allay public fears about the project, put to rest ill-founded rumors, and, above all, explain in detail how the project can benefit the **entire** community. Working out neighborhood objections with citizens' groups before the first hearing can prevent a series of lengthy, frustrating, and repetitive hearings.

Improving Intergovernmental Coordination

Negotiating the local government approval process can represent challenge enough for the developer. But often it is not only local government regulation that governs a development proposal. Frequently, developers must secure permits from more than one government entity, sometimes because their projects lie in more than one jurisdiction, but more often because state or federal agencies have jurisdiction over some aspect of the development, i.e., wetlands protection or protection of a threatened or endangered species. In any case, developers end up dealing with a complete array of separate agencies, each with its own rules and time schedules for obtaining permits. For an individual project, developers can attempt to coordinate multiple approval systems on a case-by-case basis by meeting with representatives of all

Development Approval Processing

relevant government agencies to work out a mutually acceptable, coordinated approach that minimizes duplication and maximizes concurrence of reviews.

Case Study

In Phoenix, Arizona, the city's chief planner, working with other department heads, developed a streamlined process that cut processing time dramatically without jeopardizing the health, safety, or general welfare of the local citizens. Features of Phoenix's modernized regulatory approach follow:

- **Assistance to developers before application.** A Predevelopment Advisory Team, made up of members of the Planning, Streets and Traffic, and Engineering Departments, provides information and assistance to developers before the submission of formal applications.
- **Expedited reviews and approvals through the Development Coordination Office.** The Development Coordination Office, a division of the Planning Department, is staffed by senior personnel from three city departments and assists developers with zoning matters and site plan reviews.
- **Use of administrative hearings in lieu of city council hearings.** Many matters relating to development now come before a hearing officer, leaving the city council free to deal with issues that involve policy. Administrative hearings are used for site plans, subdivision plats, lot divisions, zoning adjustments, fee waivers, grading and drainage, floodplain problems, fire code variances, off-site improvements, and building code variances.
- **Policy manuals.** Several city departments have published policy manuals that are made available to builders and developers as unified sources of information.
- **"Over-the-counter" processing.** Virtually all small projects can be processed during a single visit by the developer or builder to the Building Safety, Planning, Streets and Traffic, Water and Wastewater, and Engineering Departments. Some more substantial types of approvals such as model home permits and minor site variations can also be processed in this fashion.
- **Private sector consultants for plan review.** The Engineering Department permits developers to contract with private sector consulting engineers for review of development plans. Reviews by such consultants can typically be completed more rapidly than reviews carried out by the Engineering Department. The developer contracts for the consultant's services, paying the consultant's fee in exchange for the time gained.
- **Interdepartmental coordination for complex projects.** A development services administrator in the city manager's office can assist in expediting the approval process through interdepartmental coordination. Among other things, this official can request the release of building permits if time is critical and review processes appear to be lagging.

Source: *Challenge and Response - Volume I, Affordable Residential Land Development*, NAHB National Research Center, 1987.

LAND USE

Introduction

Urban sprawl, high land prices, traffic congestion, and growing concerns for environmental protection issues--often the result of low-density zoning--are forcing communities to reevaluate established patterns of residential development. The model of residential development traditionally preferred by American society has been the large, detached single-family home, sited near the center of a spacious lot, facing similar homes on a wide street. In fact, single-family detached units on one-third of an acre or more are the predominant type of home in existence today. The growing need for affordable housing has, however, demanded a closer look at what types of homes and communities we provide and at what cost to homebuyers. In this analysis, one key element stands out: the rising cost associated with the purchase and development of land for building sites is the single greatest reason for the increasing prices and reduced affordability of new homes.

Average Lot Prices as a Percentage of Average Home Prices

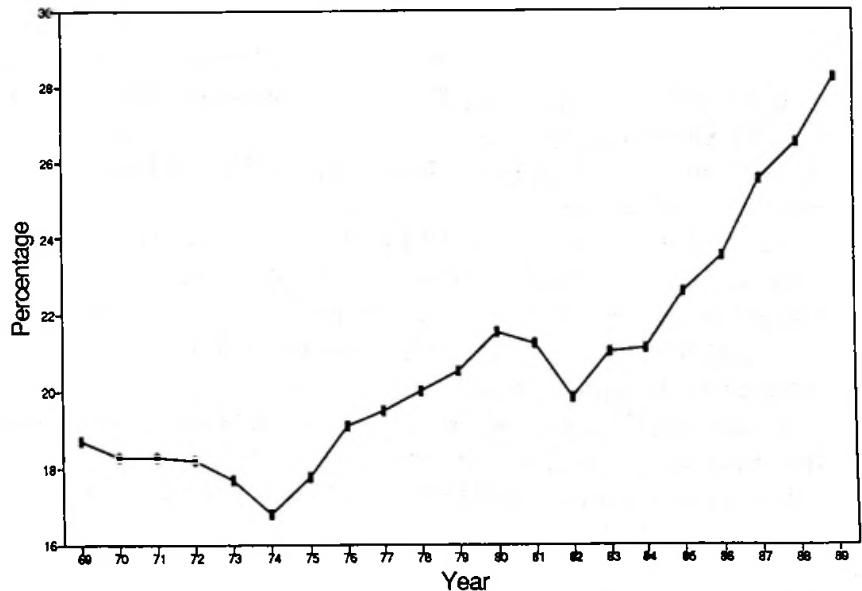

Source: U.S. Census Bureau

Land Use

According to the U.S. Census Bureau, the national average price of a residential lot increased 813 percent in current dollars in 20 years--from \$5,200 in 1969 to \$42,300 in 1989. If affordable housing is to become a reality, communities, developers and builders, and buyers may have no choice but to accept higher densities.

In many ways, local government policies influence the supply and, therefore, cost of land. Local zoning requirements, land development standards, environmental policies, and infrastructure capacity and standards--most of which are under local control--directly affect the cost of housing. Because land in its natural state is in fixed supply, it is impossible for municipalities to increase the quantity of raw land. But it is possible for most local governments to increase the supply of **buildable** land through enlightened policies.

Many options can provide less expensive and more efficient use of diminishing land resources. These techniques apply equally well to detached and attached units and to single-family as well as multifamily dwellings. Reducing land costs is accomplished through higher densities, by allowing either smaller minimum lot sizes or smaller front and side yard setbacks. In turn, smaller lots and alternative site planning techniques can dramatically influence the costs associated with site improvements. This chapter focuses on the land use regulatory framework dictated by local zoning regulations.

Increasing Buildable Land Supply

In *Land for Housing: How Local Governments Can Help Increase Supply*², the Urban Land Institute (ULI) notes the following five categories of local government actions that can help increase land supply:

- increasing allowable densities, which permit more units on available land and thus an increase in the land supply

² Regal, Stuart L. and Weitz, Stevenson, *Land for Housing: How Local Governments Can Help Increase Supply*, Urban Land Institute, 1984.

- overcoming infrastructure funding problems by emphasizing alternative revenue sources
- overcoming environmental and topographic constraints, with emphasis on combining residential development with agricultural and wetlands protection
- developing tax-delinquent and surplus public land
- using tax and eminent domain powers to influence landowner decisions

The above items are by no means all-inclusive but are starting points for community efforts directed at increasing affordable housing opportunities. The following discussions deal with issues and methods that local governments should investigate to make the most efficient use of available land resources.

Zoning, Density, and Lot Size

In general, zoning ordinances create categories of land use and thereby restrict the use of land and decrease the amount of land available for housing. Once zoning ordinances are enacted, exceptions to the ordinances usually require highly prescribed, formal procedures, including public hearings, that are time-consuming and invariably costly for the developer and the homebuyer or renter.

The relationship of zoning to land cost is direct. The Urban Land Institute found that the average lot prices in the 10 cities rated most restrictive in their zoning requirements were almost twice the average in the 10 cities rated least restrictive. During the five-year period from 1985 to 1990, the average land price increase for 30 cities across the United States was 6 percent per year compounded, compared with the consumer price index increase of 4 percent per year. Nonetheless, annual increases in the land prices of individual cities ranged as high as 27 percent in the case of San Jose, California. A 27 percent annual increase means that a building lot that cost \$70,000 in 1985 would sell for \$230,000 in current dollars in 1990. Seven cities out of the 30 in the ULI survey registered yearly land price increases of 12 percent or more.

Land Use

In addition to the increases in land costs, carpeting the landscape with low-density housing has been a recipe for disaster. The cost of sprawl in terms of traffic congestion, overextended municipal services, pollution, and lost farmland is enormous. Further, growing citizen dissatisfaction with a perceived reduction in quality of life has spawned civic organizations dedicated to slowing or halting growth. As a result, affordable housing issues are often exacerbated.

Pioneering new patterns of development involves a certain amount of risk, especially as building downsized homes on smaller lots appears to be the logical way to meet the demand for affordable single-family homes. But today's public officials and developers and builders often find themselves catching up with earlier trends that are now part of the American way of life. For example, siting higher-density development nearer employment centers makes life much easier for working couples and single-parent families by reducing commuting time and providing the "critical mass" needed for services such as daycare centers. Generally, though, the standards governing such development aspects as density, house and lot sizes, frontages, sideyards, and building orientation and siting frequently limit the housing industry's ability to deliver affordable housing.

It is significant to note that many older communities were originally subdivided into small-lot neighborhoods before the enactment of modern land use regulations. Some of the most desirable and livable towns and cities across the nation owe their uniqueness and appeal to compact land use patterns. True, these cities and towns were laid out before the advent of the automobile and the development of modern utility and emergency equipment. On the other hand, most have accommodated modern facilities adequately without sacrificing community character.

It is also interesting that planners in some of these older communities seem to have forgotten what made them interesting and desirable in the first place. Many have followed the lead of newer places in requiring large lots in new subdivisions, making the expanding parts of town look like every other community in America, overextending community services, and compounding traffic and infrastructure problems.

An approach to flexible land use should be included in subdivision ordinances that allow smaller lots for affordable housing without compromising the livability of the community as a whole.

The below ordinance language permits conventional subdivisions to be developed with some of the flexibility normally associated with cluster and planned unit developments.

Suggested Ordinance Language

Residential development design: (a) In conventional developments, the planning board may vary lot areas and dimensions, yards, and setbacks for the purpose of encouraging and promoting flexibility, economy, and environmental soundness in layout and design, provided that the average lots' areas and dimensions, yards, and setbacks within the subdivision conform to the minimum requirements of the municipal development regulations, and provided that such standards shall be appropriate to the type of development permitted. (b) Residential lots shall front on residential access or subcollector streets, not on collector streets. (c) Every lot shall have sufficient access to it for emergency vehicles as well as for those needing access to the property in its intended use. (d) The placement of units in residential developments shall take into consideration topography, privacy, building height, orientation, drainage, and aesthetics. (e) Buildings shall be spaced so that adequate privacy is provided for units.

Source: *The Subdivision and Site Plan Handbook*, Listokin and Walker, Rutgers, The State University of New Jersey, 1989.

Small-Lot Districts

As rising land prices in many markets force both finished lot costs and resulting home prices ever skyward, the most significant savings in development costs can be achieved by reducing the size of the lot. Most zoning ordinances reflect traditional biases against smaller lots by allowing only large minimum lot sizes in most residential districts. However, communities that have attempted to meet the need for more affordable housing by implementing small-lot districts have found that, as land costs rise and more small-lot units are built, consumer and community acceptance of small-lot units increases. In fact, a recent survey conducted by the National Association of Home Builders (NAHB) revealed that homebuyers are more willing to sacrifice land than space or quality within the house.

Land Use

Small-lot development not only decreases the amount of land needed for each house but reduces the linear footage of streets, sidewalks, curbs, gutters, and utilities and produces substantial savings in site preparation costs. The small-lot district designation commonly involves a reduction in the zoning district requirements and an increase in density in terms of allowable units per acre. Frequently, a small-lot ordinance provides other incentives for developers but includes measures to ensure that the quality of development is maintained.

Case Study

The city of San Antonio has had a great deal of success with its small-lot home district. The zoning change that created the district was spurred by an economic slump that found homebuyers seeking less expensive housing. Developers petitioned the city government for the special district to reduce their land costs in providing homes. San Antonio's ordinance amendment created an R-7 small-lot home district to complement its R-1 and R-5 classes. The new district reduced overall lot sizes from 5,000 to 4,200 square feet; reduced lot widths from 50 to 42 feet; created a setback arrangement that allows for off-street parking and staggered street faces; reduced sideyard setbacks, allowing zero-lot-line development; and reduced minimum rear setbacks.

The San Antonio ordinance offers design flexibility that encourages developers to build not only more affordable houses, but more attractive and interesting ones as well. Within the first 17 months of implementation of the R-7 ordinance, 10 subdivisions had been approved within the small-lot home district. Roughly 10 percent of all single-family lots approved in San Antonio since adoption of the ordinance have been located in such subdivisions. In case studies of two San Antonio developments conducted under HUD's Joint Venture for Affordable Housing, home sales in the new districts were described as outpacing projections.

Source: *Affordable Single-Family Housing, A Review of Development Standards*, American Planning Association, Planning Advisory Service Report Number 385, 1984.

In many communities, small-lot development is already included as an option in planned unit development (PUD) ordinances. However, many developers have found that PUD approvals are more complicated and time-consuming than conventional approvals and, thus, more costly. Creation of a small-lot district standardizes the approval process for higher-density development, increasing the potential cost savings

associated with more efficient use of land and reduced public improvements.

Setback Requirements

Zoning requirements generally include minimum front-, side-, and rear-yard setbacks. Reductions in these often arbitrary limits can achieve considerable land savings and reduce associated utility and infrastructure costs. The traditional practice of using large setbacks from all four boundaries of the lot reduces the usability of land on both sides of the house, particularly on smaller lots.

Residential units typically are sited in the middle of a lot, with the main building structure oriented parallel to the street. By siting the building perpendicular or at an angle to the street, developers can reduce lot widths and side-yard setbacks and achieve a corresponding reduction in lot size and the amount or "run" of utilities needed to serve the lot. Front and rear setbacks are another area of potential cost savings. A shallow front setback can be complemented with rear parking facilities and an adjoining alley. A rear alley can provide utility easements and a service lane and reduce the number of curb cuts.

Comparison of
(A) conventional and
(B) small-lot siting of houses

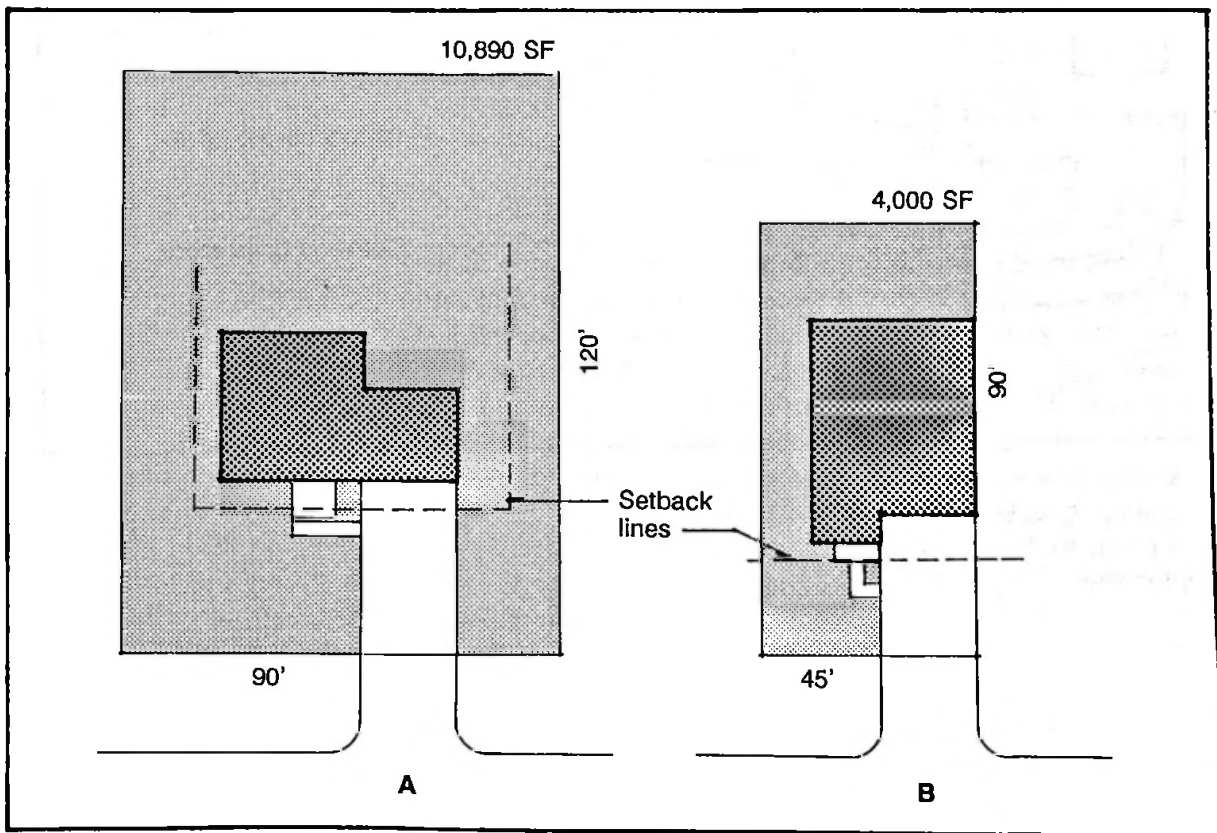

Land Use

Units can be set back at varying depths from the street and can feature alternating designs and design details that break up the monotonous repetition of garage doors or off-street parking. Furthermore, placement of units in clusters can create a sense of community and provide opportunities for consolidated open space. Other alternatives include the "pinwheel" placement of homes, with each unit opening on a different view from its immediate neighbors.

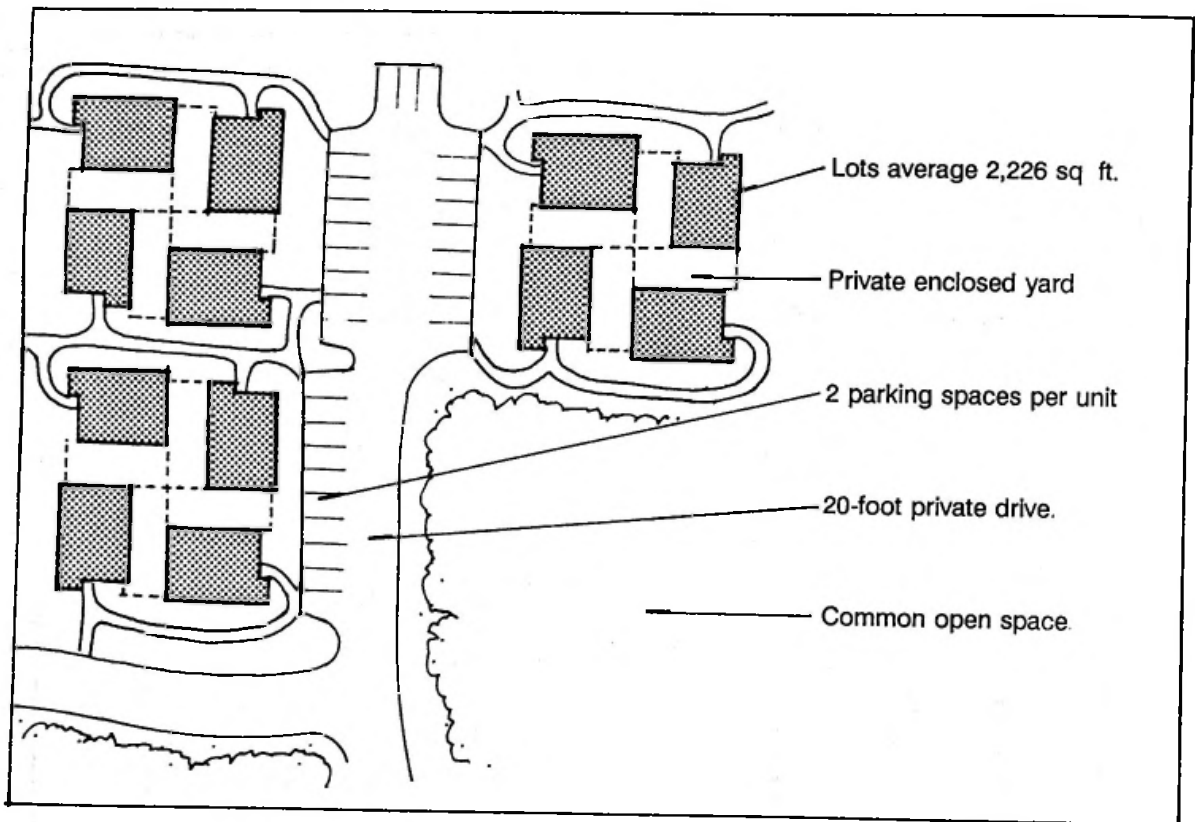

High density, "pinwheel" site plan in Lacey, Washington, by Phillips Homes

"Pinwheel" configuration in the Cottages Development, Olympia, Washington

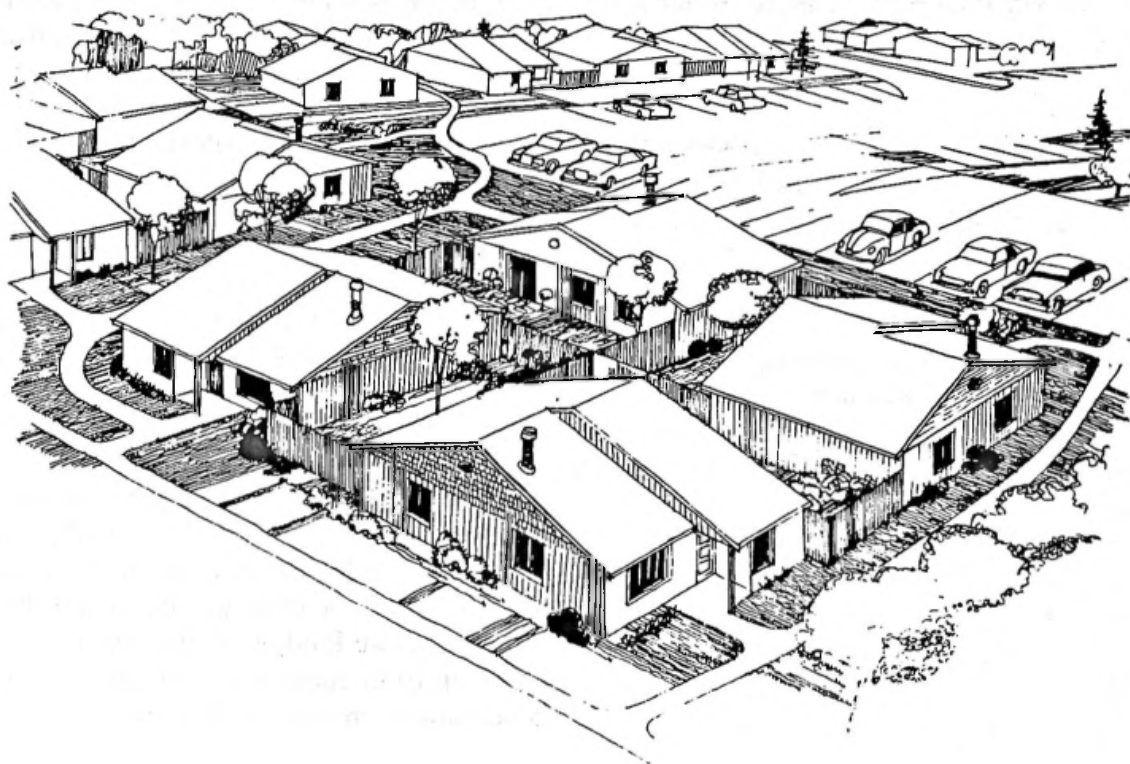

Design considerations for small-unit developments are important to the overall success of any high-density project. Developers and their project team need to devise creative design schemes that relieve any sense of overcrowding and ensure privacy. Unit design must be in proportion to the size of the lot, with small lots requiring an emphasis on maximizing open spaces and increasing privacy and usable yard areas.

Land Use

Environmental and Topographic Constraints

According to the earlier mentioned Urban Land Institute report, environmental and topographic constraints often reduce the supply of land available for affordable housing. Most notably, concern with and regulation of wetlands and other sensitive lands, steep slope areas, and endangered and threatened species can remove substantial acreage from the developable land supply. Accordingly, answers to the following questions should help determine if these constraints can be modified to help reduce land shortages:

- is the land to be protected important to the ecological balance or agricultural productivity of the community and region, or is its primary benefit simply the preservation of open space?
- what will be the probable cumulative effect of environmental constraints and related regulatory actions on developable land and housing costs?
- are there reasonable alternatives to the proposed actions that could allow residential development on part of the site without serious damage to ecological or agricultural functions?
- if the proposed actions will constrain the supply of developable land, what countermeasures can be taken to increase the land supply or facilitate development in other locations?

The ULI report contains several case studies on how different communities have dealt successfully with the issues of environmental and topographic constraints, including wetlands preservation. These case studies prove that communities can develop strategies to reconcile environmental and housing issues if they are willing to search for solutions.

Land/Price Ratios

In addition to higher density, another way to reduce housing costs is to revise some of the traditional land/sales price ratios, even though the land/sales relationship is beyond the direct control of local government and is based on customary business practices. Lenders and builders usually adhere to a 25 percent to 33 percent land to sales price cost ratio. That is, a finished lot valued at \$75,000 will result in a home priced

between \$225,000 and \$300,000. The land/price ratio has gradually moved upward since 1980 but varies considerably from market to market. In particularly affluent areas, land prices may reach as much as 75 percent of the sales price. However, what works with a \$800,000 structure on a \$1 million lot does not work with a \$40,000 structure on a \$50,000 lot.

To encourage the production of affordable housing, local government can make expensive land more affordable by permitting development at higher densities. A \$60,000 dwelling unit on a \$60,000 lot would not be easy to finance, but, by dividing a piece of land into four \$15,000 lots, a \$60,000 home would satisfy the traditional land/sales price relationship. Removing local density restrictions and providing adequate infrastructure is the best solution to affordable housing for most communities.

Land Use

Planned Unit Development

In the late 1950s and 1960s, home builders and public officials began to use an approach to zoning and subdivision regulation called Planned Unit Development (PUD). Also called Planned Residential Development (PRD), Comprehensive Residential Development (CRD), or Community Unit Plan (CUP), this approach usually incorporates a variety of housing types and land uses, higher densities, and open space and common land managed by a community or homeowners association.

PUD land use is characterized by flexibility and encourages both public and private innovation to a greater extent than is permitted by more traditional zoning and subdivision controls. On one hand, this flexibility makes it possible for the developer to change long-term development plans to meet current market demands. On the other hand, it gives local authorities the latitude to negotiate with the developer and encourages tradeoffs on density, mixed use, and street and utility requirements for such desired amenities as open space and recreational facilities.

Ancillary Apartments

Ancillary or accessory apartments such as "granny flats" and garage apartments provide affordable rental housing in more affluent neighborhoods and make for-sale homes more affordable by providing owners with rental income. Without changing the look or scale of a neighborhood, such ancillary units could double an area's density. A California nonprofit, the San Francisco Development Fund, conducted a demonstration program--called the Double Unit Opportunity program--to encourage creation of such units. They found that accessory apartments can be a modest source of affordable housing by increasing the efficient use of existing land and structures.

Site Planning

Site planning and land development represent major areas of potential cost reduction for most developers and builders. These costs often increase in direct proportion to the

complexity of zoning requirements, subdivision regulations, and levels of required standards.

In fact, most of the development cost savings resulting from changes in development standards discussed in this manual can be attributed to increased density. In most of HUD's Joint Venture for Affordable Housing demonstration projects, reducing land costs per housing unit was the single biggest factor in achieving affordability. Higher density allows land and improvement costs to be spread over a larger number of units. Reduced frontage and frontyard setbacks allow for less pavement and sidewalk per unit, shorter utility runs, and reduced material costs. By contrast, wide streets and rights-of-way, although sometimes functionally justifiable, add to land development and, ultimately, housing costs.

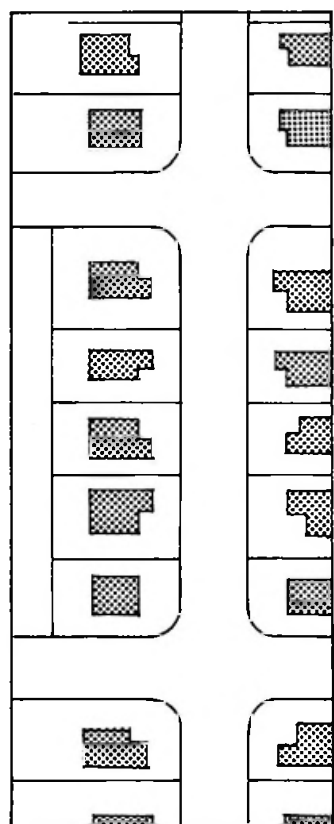

Conventional subdivision grid pattern

Site planning for higher-density development poses challenges in the design and aesthetics of housing and land use. To maintain and even improve livability in the context of increased density, developers and communities must devote special attention to the following guidelines for site planning:

- encourage site plans that increase density and maintain open space, preserve natural features, and provide for adequate parking and privacy landscaping
- avoid development plans with wide streets in grid patterns, large lots, deep setbacks, and low density
- reduce or eliminate setbacks from all four lot boundaries
- support "zero-lot-line" and "Z" lot configurations

Traditional Approaches

Traditional housing development plans prevalent in the post-World War II period are characterized by a grid pattern of wide streets with houses sited on large lots with deep setbacks. Such plans were widely believed to afford privacy and provide desirable residential environments. Local housing ordinances supported and continue to support the then-current philosophy of large-lot development by restricting density per acre and specifying large setbacks.

Land Use

However, there is little reason to believe that this extravagant use of land contributed significantly to the goals of desirability and privacy. Nothing intrinsic in the large-lot development pattern promotes or increases privacy, and "desirable residential environments" often gave rise to today's pattern of urban sprawl. In many instances, communities made little provision for open space or common land or for integration of common open space into the overall design of the development. Further, large-lot development does not make efficient use of community services such as roads and water and sewer systems that must traverse considerable distances to serve all units. The cost of wasted capacity is borne by both residents and the public sector.

Innovative Approaches

There are a number of ways that well-planned, higher-density development can contribute to, rather than detract from, community aesthetics and livability. For example, it is often easier to increase the amount of common open space and preserve attractive natural features in a plan for higher-density development.

Other potential problems of higher density--particularly privacy and parking--can be overcome through innovative planning. Privacy can be provided by coordinating the placement of fences and/or plantings. For attached units, sound-conditioning can be incorporated into common walls.

Rearyards and front entry courts can be enclosed. Parking can be provided through placement of garages or carports within parking areas and by use of planted islands.

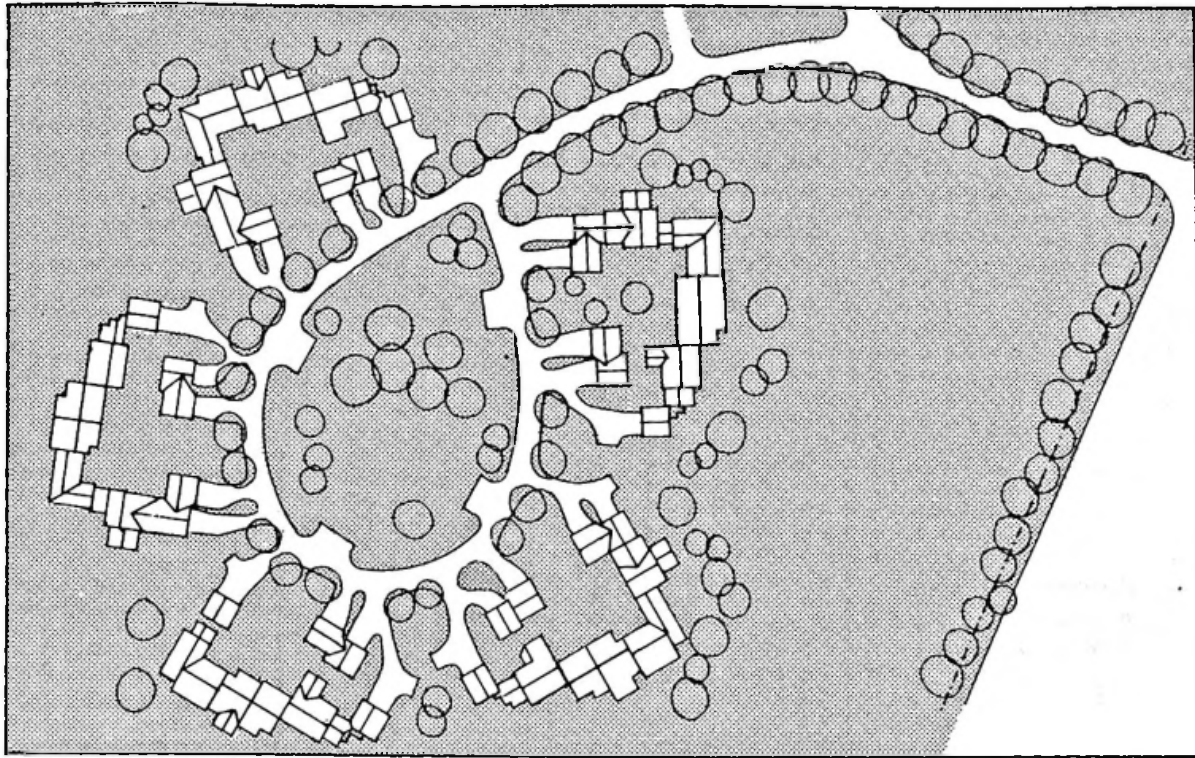

Typical plan of a cluster neighborhood

Zero Lot Line

Zero-lot-line (ZLL) siting is a useful way to make the most of a small lot. This development technique permits units to be sited on one or more lot lines, making efficient use of available space by creating a single, usable yard area rather than two unusable narrow sideyards. Garages can be moved from one side of the unit and placed at either the front or rear of the house.

A commonly expressed concern with small-lot homes and ZLL sitings is the potential lack of privacy. To counter this, walls that are located on lot lines are frequently required to

Land Use

be windowless, with a small easement granted for maintenance.

The zero-lot-line approach is basically a detached version of the duplex home. That is, by moving one duplex unit away from the common wall to the other side of the lot, high density is maintained while creating a freestanding, single-family detached subdivision. Usually, main living areas are oriented toward the sideyard, taking advantage of the "court."

- (A) *Conventional siting practice*
- (B) *Zero-lot-line siting*

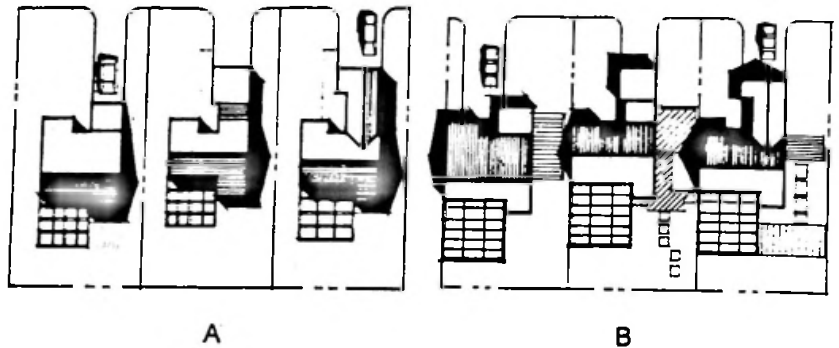

ZLL homes can be either attached or detached single-family homes. A common feature of the ZLL home is the atrium, with a central patio serving as the focus of a one-story home, sometimes augmented by a side yard for increased interior light.

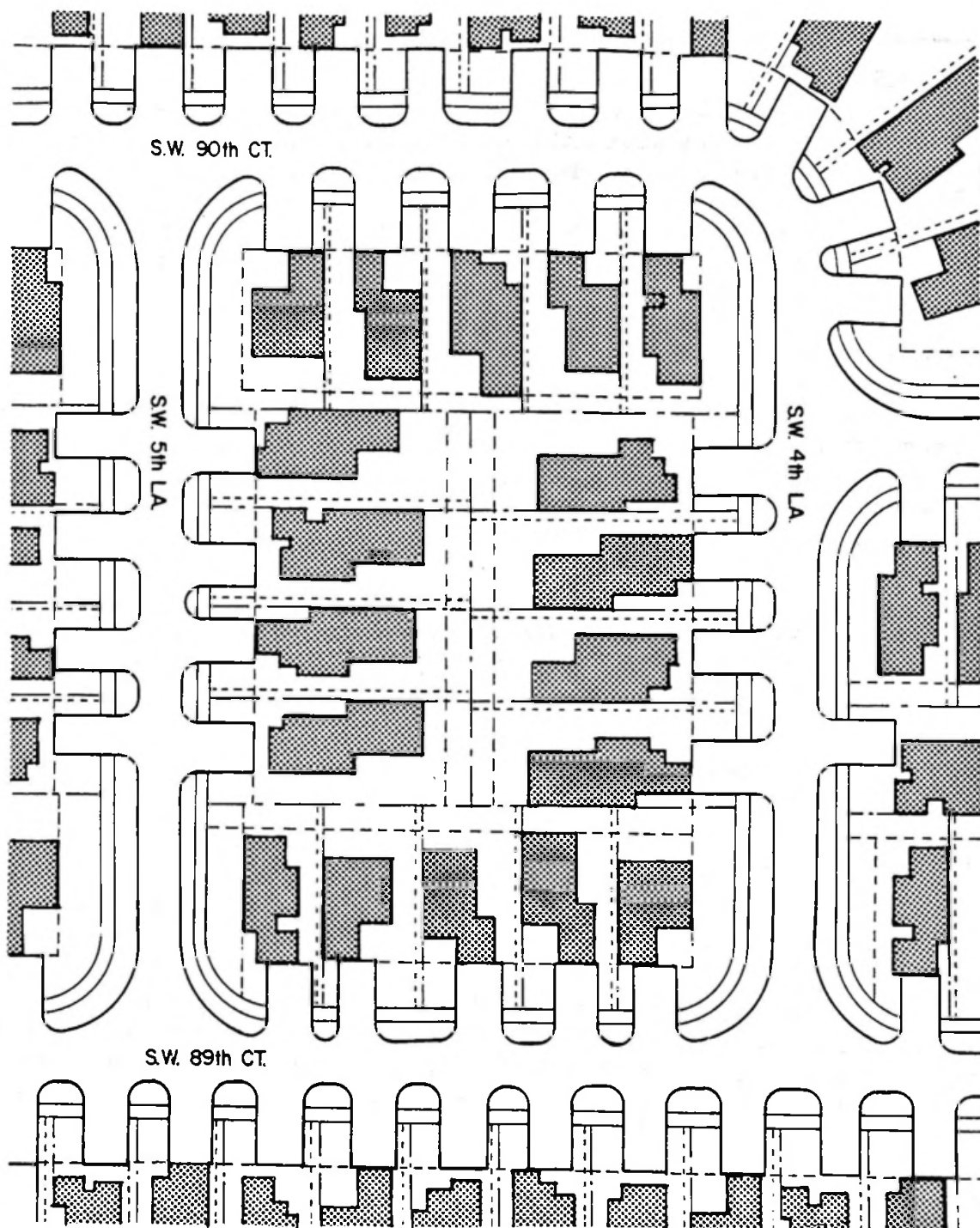

Dade County

Case Study

Florida's Dade County enacted a ZLL ordinance in 1979 with two goals in mind: more efficient use of land to increase available affordable housing and the integration and design of indoor and outdoor areas. Bird Road Estates combined 64 ZLL homes with 44 conventionally sited homes that served as a buffer between the small lots and surrounding development. The developer kept lot coverage at 26 percent, far below both the 50 percent allowed in other small-lot developments and the 35 percent approved for conventional lots. The U-shape of the homes (ranging in size from 1,713 square feet to 1,193 square feet) incorporated a small patio that faced the windowless neighboring wall and provided a strong transition between the indoor and outdoor areas of the home. To allow for maximum integration of indoor and outdoor areas, county officials insisted on a 15 percent minimum of open wall space to accommodate windows and glass doors. As is common, the developer built the homes larger than the minimum allowable unit size; considerations of marketability frequently play an important part in developer decisions to exceed minimum requirements.

Source: *Affordable Single-Family Housing, A Review of Development Standards*, American Planning Association, Planning Advisory Service Report Number 385, 1984.

"Z" Lot Configuration

An adaptation of the zero-lot-line approach is an innovative concept called "Z" lots. Sometimes called "herringbone" or "sawtooth," these angled lots expand frontages and expose more of the home to the street. Because of the angle, garages do not dominate the streetscape as much as in traditional rectangular lot layouts, especially if garage door locations are alternated from one house to the next. The Joint Venture for Affordable Housing demonstration project in Everett, Washington, included a variation on the Z-lot approach with garages set at an angle to the homes and the street.

Typical "Z" lot

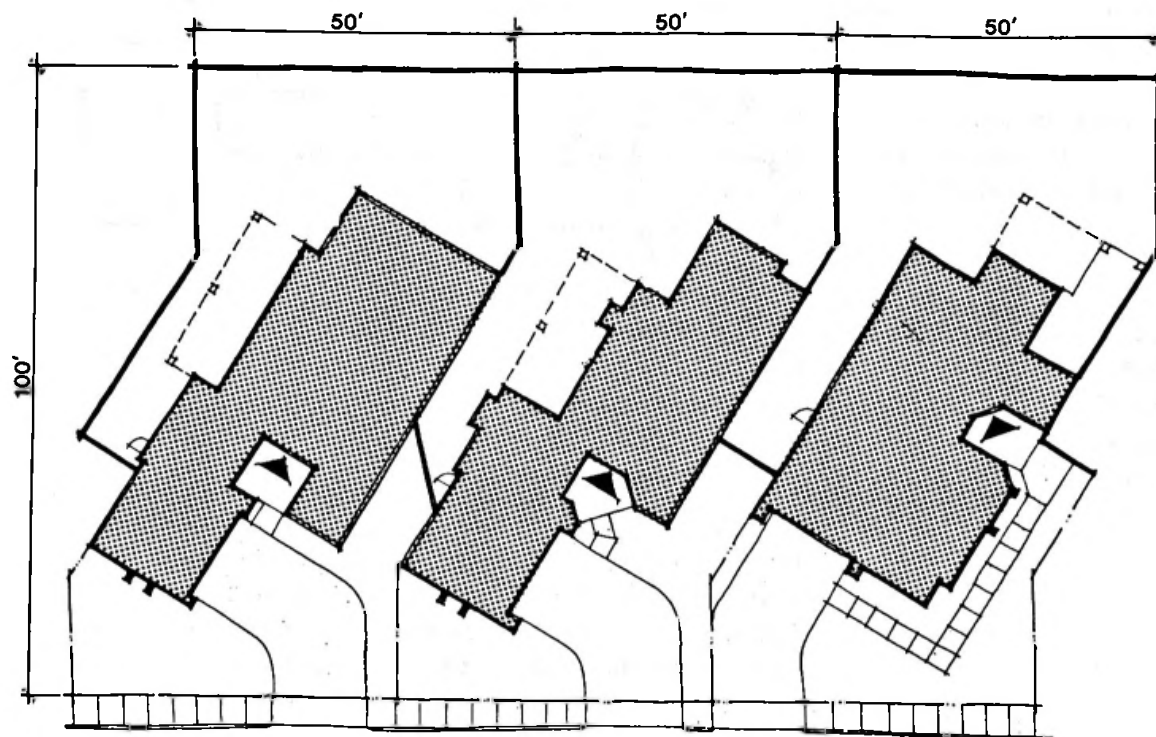

Clustering

Many clustering arrangements have been successfully designed to combine higher density, aesthetics, and livability. Clusters can be incorporated into site development plans to preserve open space for community use while reducing development costs.

In addition, it has been found that such arrangements can increase the sense of community among residents within each cluster and among adjacent and neighboring clusters. A cluster can become a psychologically identifiable "place" more easily than can rows of detached houses on rectangular lots. Groups of clusters can relate to each other through joint access to common land.

Clusters can be designed for siting single-family detached or attached homes, duplexes, quadruplexes, etc.

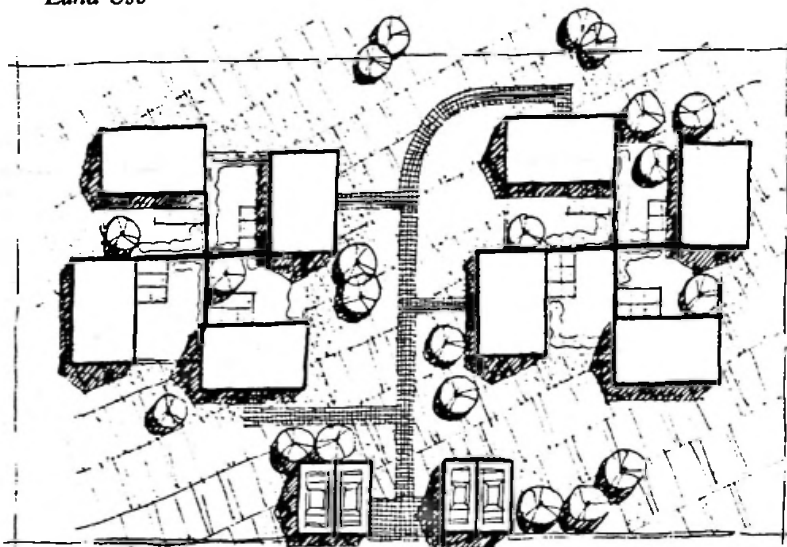

Typical "pinwheel" lot arrangement

Source: Mithun Bowman
Emrich Group, Bellevue, WA

Land planning using the cluster approach achieves many aims, not the least of which is its considerable potential for reducing costs. Clustering is an attractive, cost-effective way to achieve maximum land efficiency while increasing the market value of the finished units. A recent survey conducted by the National Association of Home Builders affirms that prospective homebuyers feel that overall lot size made less of a difference than did interior space.

Clustering takes one of two forms:

- dwellings or small lots organized around courts or cul-de-sacs
- attached single-family units (duplexes, triplexes, and quadruplexes) arranged around private courtyards or parking compounds

By clustering lots on the most buildable portion of the site, the rest of the site remains in open space and utilities can be centralized, thereby reducing public improvement costs. Developing a cluster neighborhood can mean building at higher densities, and, in some cases, a community must grant density bonuses as an incentive to encourage builder use of the cluster techniques. Generally, however, cluster development increases only the net density of a site, not the gross density.

By enabling builders to locate their units on the buildable portions of the site, clustering increases the chances that the development will be built to its maximum site potential under the permitted densities. Under conventional lot layout, a developer who was not able to build on portions of the site because of poor soils, steep slopes, or other resource constraints would be forced to reduce the number of total units planned for the site.

Homebuyers usually prefer the advantages of a natural landscape with mature trees and open spaces; clustering maintains and enhances this feature. By siting homes close to each other, less grading is required to finish the site. Natural stormwater drainage features can be retained and eliminate the need for expensive drainage systems. Open space can function both for water retention and as passive or active recreation areas.

1870
The first of the year was a very
dry one, and the crops were
very poor. The weather was
very hot, and the crops were
very dry. The crops were
very poor.

The second of the year was a
very wet one, and the crops
were very good. The weather
was very cool, and the crops
were very green. The crops
were very good.

STREETS**Introduction**

Everyone benefits from street improvements that are functionally adequate, durable, and cost-effective. Builders know that inadequate or deteriorating streets can be a major cause of buyer dissatisfaction. Homebuyers want streets that are safe and functional yet provide an attractive residential environment. The cost of maintaining streets is an important concern to public officials and the community as a whole. But excessively wide streets that are designed to highway standards do not contribute to any of the above and, in fact, compromise housing affordability.

Although extensive studies of higher-order streets and highways have been conducted by universities, highway departments, and the federal government, little statistical information or research has focused on the refinement of residential street standards. Yet residential streets carry the vast proportion of any community's traffic. Over the years, rigid zoning ordinances and subdivision regulations have produced repetitious street patterns and monotonous streetscapes and have often contributed to housing affordability problems. Overly stringent residential street standards do not necessarily ensure the best long-term value for either the community or the homebuyer.

In the absence of appropriate research-based guidelines for the design of residential streets, municipalities often have either adopted modified highway design standards, developed standards intuitively without benefit of thorough analysis, or "borrowed" standards from other communities. For example, emergency vehicle access often provides for emergency possibilities that are highly improbable. Because excessive traffic speed causes far more injuries and deaths than residential fires, residential streets designed solely for high-speed emergency vehicle access actually decrease the overall safety of the neighborhood.

Too often local decision makers forget that residential streets are part of the neighborhood and, as such, are used for a

variety of purposes for which they were not designed. Residential streets not only provide direct automobile access to occupants' homes, they also provide a visual setting, a pedestrian circulation system, a meeting place for residents, and, like it or not, a play area for children. Streets designed and engineered solely for the convenience of easy automobile movement overlook their many overlapping uses. In other words, streets should be designed to serve the neighborhood; the neighborhood should not be designed to serve the streets.

Major street design problems fall into the following three categories:

- **Overdesign.** Wasteful overdesign serves no useful purpose and adds unnecessarily to environmental damage by frequently requiring more cut and fill and more paving. Overdesign also causes greater impact on groundwater supply, higher erosion potential, and increased heat build-up in the summer. Unnecessarily wide streets built to highway standards are costly to install and to maintain. Additional first costs are borne by the homeowner and contribute to escalating housing prices while excessive maintenance costs are passed on to the community in the form of taxes.
- **Lack of order.** When the needs of the neighborhood are not considered, streets often lack an appropriate sense of order. Without order, there are streets and houses but no neighborhood. The sense of community is lost.
- **Residential character.** When streets are designed to move rather than control traffic, vital neighborhood concerns are ignored. Wide, straight streets encourage speeding, and traffic with no particular need to be in the neighborhood is channeled through the community. Safety, peace, and quiet are sacrificed.

Principles of Residential Street Layout

The design of a residential street should be appropriate to its functions, which include not only providing circulation but also enhancing a residential community's living environment.

According to the Institute of Transportation Engineers, the design of local streets must recognize the following factors:

- safety for both vehicular and pedestrian traffic
- efficiency of service for all users
- livability of the residential environment
- economy of land use, construction, and maintenance

The Institute of Transportation Engineers developed the following residential street design criteria:³

- paved access should be provided to all developed parcels
- street design should discourage through traffic
- layout should not create excessive travel lengths
- street system should be logical, understandable, and easily read by the user
- local systems should not detract from the efficiency of adjacent major streets
- local systems should not rely on extensive traffic regulations or controls
- traffic generators such as schools, churches, or neighborhood shops within residential areas should be considered in the circulation pattern
- residential streets should clearly communicate their function and place in the street hierarchy
- local systems should be designed for relatively low-volume traffic; collectors, however, should be planned to accommodate peak demands
- to discourage excessive speeds, streets should be designed with curves, changes in alignment, and short lengths and should not be wider than necessary
- conflict points between pedestrians and vehicles should be minimized
- minimum area should be devoted to streets, consistent with safety and livability
- the number of intersections should be minimized
- street layout should allow economic development of land
- streets should be responsive to topography and other natural features

³ *Recommended Guidelines for Subdivision Streets*, Institute of Transportation Engineers, 1984.

Streets

- residential areas should provide for public transit service as appropriate
- streets should be designed for local emergency services
- pedestrians, nonmotorized vehicles, and truck deliveries should be accommodated
- streets should enhance the community's visual image

These principles suggest that residential street standards should be developed for a hierarchy of streets. Streets carrying through traffic should be separated from those providing access to residential properties. For example, interstate highways are designed for high-speed through automobile and truck traffic with no direct property access. At the other end of the spectrum are dead-end residential streets designed only for property access. Highways and arterial streets are considered traffic systems; residential streets should be considered more a part of the neighborhood than part of a traffic system. As such, the street systems and their functions should be easily recognizable by users so that the intended function is readily apparent. Too often, a lack of distinction among residential streets invites high-speed traffic into an area where it does not belong.

Most residential streets are public streets that developers dedicate to the local government upon or shortly after completion. Local government then becomes responsible for maintenance. Private streets are owned and maintained by a homeowners association or other community group. Some communities allow flexibility in the design of private streets but have overly restrictive standards for public streets. However, ownership of a street should not be a factor in its design or function. Design of all streets, public and private, should be based on volume and characteristics of expected traffic and on the likely amount of on-street parking. Accordingly, costs of street construction and maintenance can be minimized on a per dwelling unit basis.

Street Hierarchy Classification System

The four-category hierarchy of streets, in descending order, includes arterial, collector, subcollector, and access streets. An arterial is a high-volume street with the function of conducting traffic between communities and major activity centers. Residential streets may fit into any category except arterial and are defined below.

Suggested Ordinance Language

Collector street: A street which carries residential neighborhood traffic, but which provides no or limited residential frontage.

Subcollector street: A street which provides access to abutting properties and which may also conduct traffic from residential access streets that intersect it.

Access street: A street which provides access to abutting properties; it shall be designed to carry no more traffic than that which is generated on the street itself.

Special purpose streets:

(1) Alley: A special type of street which provides a secondary means of access to residential lots, normally located at the rear of the lots. (2) Marginal access street: A street parallel and adjacent to a collector or higher level street which provides access to abutting properties and separation from through traffic. Such streets shall be designed at the level of either residential access streets or subcollector streets as anticipated traffic volumes dictate. (3) Divided street: Such streets shall be designed to the aggregate dimensions of both segments.

Source: *Performance Streets, A Concept and Model Standards for Residential Streets*, Bucks County Planning Commission, Doylestown, PA, 1980, and *Residential Streets, Second Edition*, American Society of Civil Engineers, Urban Land Institute, National Association of Home Builders, 1990.

Streets

Average daily traffic (ADT)--or average daily trips--is one factor in the design or alteration of streets, but should not be the sole factor. A generalized classification scheme based on ADT is presented below.

Suggested Ordinance Language

Residential Street Classes Based on Traffic Volume

<u><i>Class</i></u>	<u><i>Usual ADT Range</i></u>
<i>Collector</i>	1,000-3,000
<i>Subcollector</i>	250-1,000
<i>Access Street</i>	0-250

Source: *Performance Streets, A Concept and Model Standards for Residential Streets*, Bucks County Planning Commission, Doylestown, PA, 1980.

ADT should not be the only index for local residential street design. If designed properly, subdivision streets should be noticeably devoid of traffic and excessive speeds and should encourage residential driving attitudes and habits that differ from highway and arterial driving behaviors. Momentary yielding to resolve minor traffic conflicts is practical at residential street speeds because delays are minimal and expected. Traffic yields to drivers backing out of driveways or backing drivers yield to oncoming traffic. When parked vehicles impede two-way traffic lanes, approaching vehicles often yield and then proceed with caution. Short delays are expected and accepted when vehicles such as garbage trucks or emergency services that use streets infrequently are in the neighborhood. Designs that encourage cautious driver behavior result in reduced speeds and, thus, safer streets.

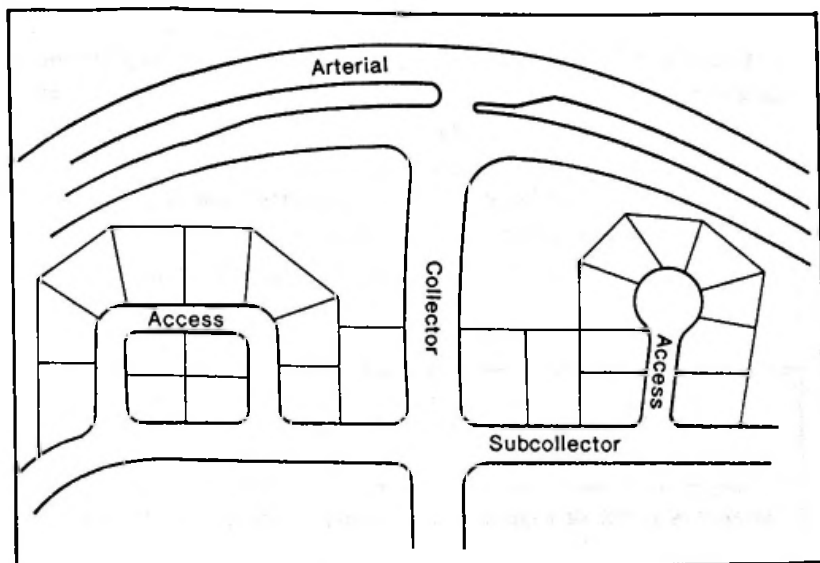

Access street use

Therefore, the primary considerations in selecting street standards are the characteristics of local residential traffic and residents' expectations. ADT should be used only to provide additional guidance. Most sources estimate that the ADT per single-family detached home ranges from eight to ten vehicle trips per day. Therefore, ten homes on a cul-de-sac street will normally generate 80 to 100 vehicle trips per day.

Factors other than ADT that should be considered in making decisions about street design include the following:

- lot widths and residential density
- availability of off-street parking
- vehicle ownership and use characteristics of present or projected neighborhood residents
- family size and age characteristics expected within the neighborhood as reflected in location, kind, size, and price or rent of dwellings
- proximity to shopping and other support or service facilities
- proximity to public transportation
- consideration of the community's public services such as trash collection, snow removal, and public safety

Streets

Because some of the above factors are not easily quantifiable, observing existing neighborhood patterns will be useful in determining probable local traffic characteristics.

Access and Street Alignment

Collector streets should connect with streets of equal or higher class at two or more intersections.

Suggested Ordinance Language

Every residential collector must be provided with no fewer than two access intersections to streets of equal or higher classification in the streets hierarchy.

Source: *Performance Streets, A Concept and Model Standards for Residential Streets*, Bucks County Planning Commission, Doylestown, PA, 1980.

Neighborhood access through subcollector streets can be provided by either single or multiple connections with collector or arterial streets. Advantages of a single neighborhood entrance include elimination of through traffic and short-cutters, increased security, and a greater sense of community. Advantages of multiple access include reduced internal congestion and diffusion of traffic impacts on the external road system.

Street alignment should be the result of an evaluation of several factors, including topography, soil and geologic conditions, drainage patterns and runoff quantities, length and type of streets, purpose of individual streets, and desired design character. Alignments should avoid both endless vistas of trafficways and labyrinths that are irrational and confusing.

An accurate topographic map is necessary for optimum residential neighborhood planning. The land planner should be aware of development, construction, operation, and maintenance efficiencies that accrue from properly interrelating street layout with natural topography.

In the past, new subdivision streets tended to follow a linear grid pattern with straight streets, especially when the land was relatively flat or could be so graded. More recently,

curvilinear street patterns have become predominant in new residential development. In addition to creating a more attractive neighborhood, streets that follow natural contours can achieve substantial economies. Further, stormwater management usually becomes less complex when planners use as many natural drainage paths as possible. Whatever their relative advantages, both linear and curvilinear layouts should respect the street hierarchy.

Vertical and Horizontal Alignments

Vertical alignment--the rise and fall over hills into low spots--of residential streets should ensure that drivers can negotiate hills in adverse weather and that sight distances are adequate for safety. Horizontal curves on low-speed residential streets are not as critical a safety factor as for higher-speed streets. More important on residential streets is maintaining adequate sight distances for the safety of pedestrians and pets.

Number of Lanes and Pavement Widths

Where the primary functions are to provide access to single-family units and to foster a safe and pleasant environment, streets should be designed to ensure at least one unobstructed moving lane if parking is available on both sides. User inconvenience occasioned by the lack of two moving lanes is remarkably low in most single-family subdivisions where the distance between point of trip origin and collector street is

Suggested Ordinance Language

Moving lanes. All residential access streets shall provide at least two lanes. Where a third lane to accommodate spillover parking is not required, occasional short term parking for service vehicles shall be permitted within the moving lanes. All subcollector streets shall be provided with two continuous moving lanes within which no parking is permitted.

Source: *Performance Streets, A Concept and Model Standards for Residential Streets*, Bucks County Planning Commission, Doylestown, PA, 1980.

Streets

one-half mile or less. Opposing traffic yields in the parking lanes until there is sufficient width to pass. In high-density multifamily neighborhoods, two travel lanes may be required.

Pavement widths have a significant effect on vehicular speed, visual scale, and cost of construction and maintenance. Widths have evolved largely from considerations of the largest vehicle that might use the street and from the concept that traffic, once in motion, must remain in motion. Such approaches may be appropriate for arterial streets but are difficult to justify for residential streets. Designers should select the minimum width that satisfies realistic, reasonable needs. The tendency to equate wider streets with better streets and to design traffic and parking lanes as though the street were a "microfreeway" is highly questionable, unsafe, unattractive, and expensive.

For cul-de-sacs, pavement widths of between 22 feet and 24 feet are adequate for one moving lane and two parking lanes. Widening the street does nothing to increase capacity but does tend to encourage higher-speed driving.

On subcollectors, 26-foot-wide pavement provides either two parking lanes and one moving lane or one parking lane and two moving lanes. If no off-street parking is provided on subcollectors, a 28-foot-wide pavement may be preferable when continuous parking is expected along both sides of the street. On collector streets designed for higher speeds, a 36-foot-wide pavement provides two 10-foot-wide moving lanes and two eight-foot-wide parking lanes. However, if no residences front on the collector, a 24- to 26-foot-wide pavement with graded shoulders for emergency parking is sufficient.

Pavement widths can be narrowed further by eliminating one or both parking lanes. Rural streets and collector streets that do not provide direct access to homes are not used for parking and do not require a pavement width greater than that which will allow two cars to pass. Pavement widths of 18 feet to 20 feet are adequate for such roads.

Following are two example ordinances. Notice that the second example, for residential access streets only, is more complete in its description of the types of development allowed on each residential access street.

Suggested Ordinance Language

<i>Pavement Widths</i>	
<u>Street Type</u>	<u>Pavement Width (ft.)</u>
<i>Collector, parking both sides</i>	36
<i>Collector, emergency parking only</i>	26
<i>Subcollector</i>	26
<i>Access</i>	22-24

Source: *Residential Streets, Second Edition*, American Society of Civil Engineers, National Association of Home Builders, Urban Land Institute, 1990.

Streets

Suggested Ordinance Language

Residential Access Street Widths

<u>Intensity of Development</u>	<u>Parking On-lot</u>	<u>Provisions Spillover</u>	<u>Cartway Width (1)</u>	<u>Driveway Access Permitted</u>
Frontage on open space No residential lot frontage	None (2)	None (2)	18	No
Lots 5 acres or larger w/ deed restricted against future subdivision	On-lot	On-lot	16	Yes
Lot widths of 100 or greater	On-lot	On-lot	18	Yes
Lot widths 40-100	On-lot	On-street	24 (3)	Yes
Lot widths less than 40	On-lot	On-street from rear alley, or in parking lot	24 (3)	No
Lot widths less than 40	On-lot	Off-street parking lot	18	Yes

(1) If curbing is required, add 2 feet to the cartway width.

(2) It is assumed that no parking will be provided on-street and that no individual residential lot will have off-street parking with direct access from this street. Access to a common off-street parking lot shall be permitted.

(3) Cartway width may be reduced to 20 feet for marginal access streets.

Source: *Performance Streets, A Concept and Model Standards for Residential Streets*, Bucks County Planning Commission, Doylestown, PA, 1980.

Speed

Traffic speeds on residential streets are affected by the following:

- open width or clearance of the street
- horizontal and vertical street alignment
- number of access points to the street

- number of parked cars or other obstructions on the street
- signs and signals at controlled intersections

Because of short lengths, the likelihood of parked vehicles, the presence of children and pets, and other reasons, residential streets should be designed for low speeds.

Suggested Design Ordinance

Design speed for access and subcollector streets should be no greater than 20 mph. For collector streets, design speed should range between 25 and 35 mph, depending on terrain and sight distances.

Source: *Performance Streets, A Concept and Model Standards for Residential Streets*, Bucks County Planning Commission, Doylestown, PA, 1980.

Gradients

Local access and subcollector street grades should be as flat as possible, consistent with surrounding terrain, stormwater drainage capacity, and potential icing conditions. In hilly terrain, there may be no practical way to avoid street gradients steeper than those considered maximum in less severe topography. In such cases, designers should devote particular effort to specifying the flattest possible gradients at intersections.

Streets should be crowned to remove water from travel lanes and to prevent ponding. Pavement cross-slope is usually specified at about 1/4 inch per foot. Inverted crowns, with drainage down the center of the street, have been successful in areas of relatively little average precipitation and where icing is not a problem.

Cul-de-Sacs and T-Turnarounds

Communities should discourage paved turnaround radii of 40 feet or greater because they create large, unattractive expanses of pavement that are expensive to construct and maintain and that contribute needlessly to stormwater runoff. If cul-de-sacs are used, a 30-foot radius is adequate for all automobiles. Some trucks and fire equipment may have to complete one back-up movement in a cul-de-sac with a 30-foot radius. When considering the amount of time such vehicles use cul-de-sacs, it is neither logical nor appropriate to design them for seldom occurring events.

For affordable housing, a more practical approach to the traditional cul-de-sac is the "hammerhead" T- or Y-shaped turnaround at the end of short residential streets. These turnarounds require all vehicles to back up, but this minor inconvenience can be easily justified when considering the economic impact. A typical cul-de-sac uses about six times the land area as does a T-shaped turnaround.

Lots on a cul-de-sac are pie-shaped--narrow in front and wide in the rear--and consume about 20 percent more land than a rectangular lot with uniform frontage width. In other words, about one lot is wasted for every five houses built on a cul-de-sac. Lot layout on a T-shaped turnaround can be more similar to all other lots on the street. Parking restrictions on T-shaped turnarounds are necessary.

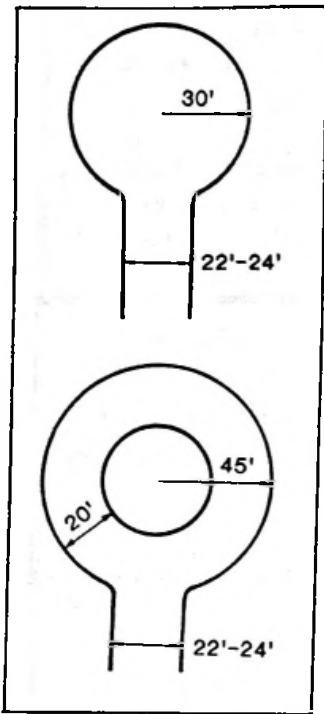

Cul-de-sacs and "T"-turnarounds

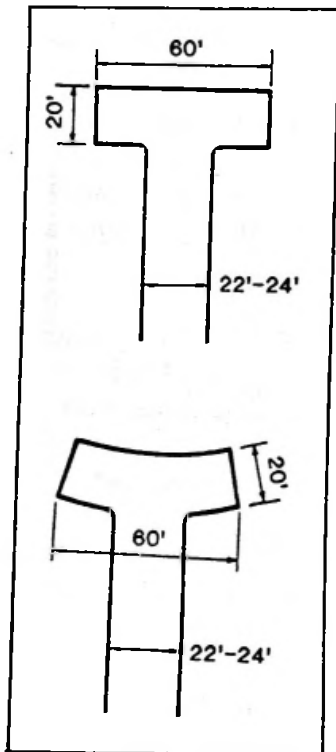

Suggested Ordinance Language

Cul-de-sac Turnarounds: An unobstructed 14-foot-wide moving lane with a minimum outside turning radius of 30 feet shall be provided at the terminus of every permanent cul-de-sac. The terminus must also be designed so that spillover parking needs are met in conjunction with the remainder of the street. Cul-de-sac subcollector streets with an anticipated traffic volume exceeding 500 ADT shall be prohibited. In no case shall a subcollector cul-de-sac street exceed 1,000 feet in length.

"T"-turnarounds: A "T"-turnaround shall meet the following minimum dimensions:

- | | |
|--|--------------|
| (1) Inside turning radius | 26 feet |
| (2) Outside turning radius | 38 feet |
| (3) Straight backup lengths (2 required) | 30 feet each |

Source: *Residential Streets, A Concept and Model Standards for Residential Streets*, Bucks County Planning Commission, Doylestown, PA, 1980.

Loops

Loop streets can reduce costs, especially if designed for one-way traffic. A 16- to 18-foot pavement on a one-way loop will accommodate both moving traffic and a lane of parked cars, as illustrated.

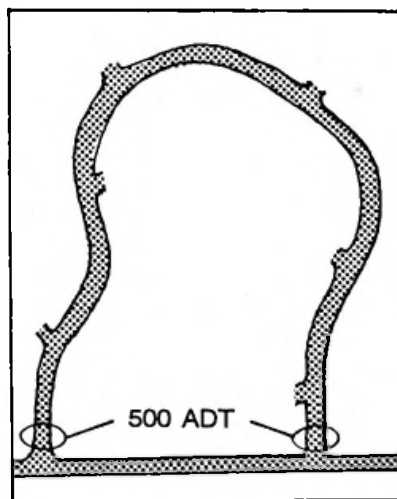

Loop Street

The one-way loop provides two points of ingress and egress for fire equipment and other emergency vehicles.

Streets

Alleys

Alleys have functioned well in many older neighborhoods and can be used effectively in new development. By locating garages and driveways at the rear of the property, the streetscape is improved by eliminating numerous driveways and garages that dominate the front elevation of smaller homes. Trash pick-up from the alley also eliminates unsightly curbside garbage containers. Utility placement under the alley eliminates the need for excessive street right-of-way widths. To use land efficiently, alleys should be no wider than is necessary for the passage of a single service vehicle. A 12-foot-wide pavement can easily accommodate the widest of truck bodies with room to spare on both sides. For stormwater runoff in alleys, an inverted crown with a two-inch invert is preferable to curbs and gutters, which have limited usefulness in providing access to rear properties.

Alleys make sense for affordable housing **only** when street widths are reduced and when street-side rights-of-way for utilities and sidewalks are eliminated.

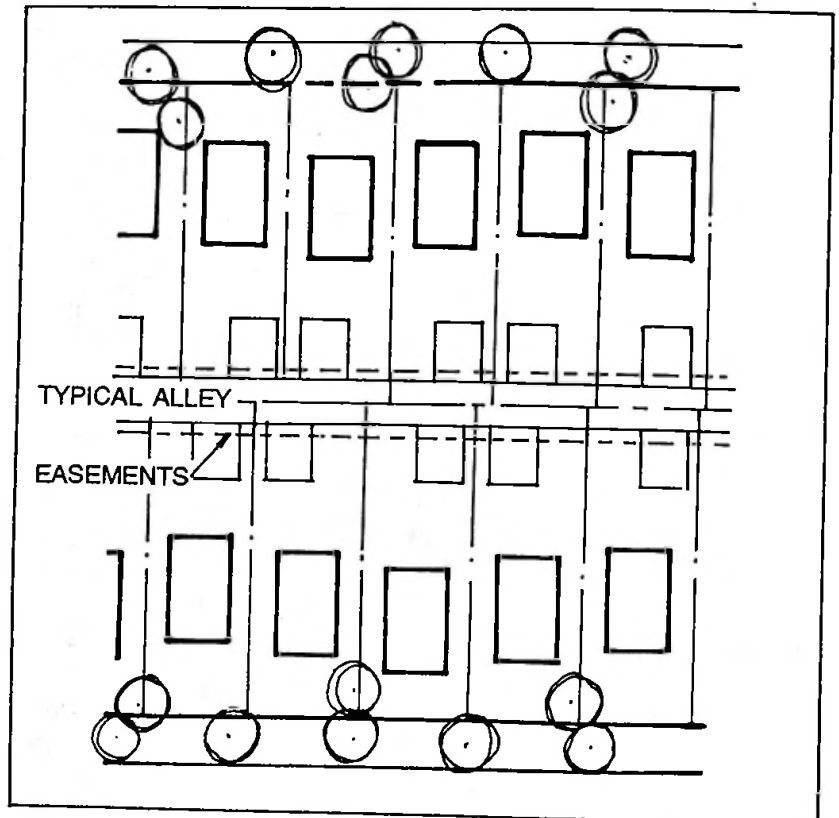

Street Construction

Construction of a safe, durable roadway is a function of traffic volume, the weight of vehicles expected to use the roadway, and underlying soil conditions. State highway departments generally prescribe minimum standards for pavement thicknesses and for construction materials and methods for roads that ordinarily carry heavier vehicles and more traffic than expected on subdivision streets. However, many municipalities and local governments adopt standards for subdivision streets that reflect those for state roads. Significant cost savings can be realized by analyzing the functional requirements of subdivision streets and constructing them accordingly.

Emergency Vehicles, Moving Vans, Snow Plows, Garbage Trucks

Every home within a community should be readily accessible to emergency equipment that serves residential areas. While the arrival of such equipment is usually time-critical, its departure--except for ambulances--is typically less hurried. Oversized equipment such as hook-and-ladder trucks do not respond to single-family residential fire calls and do not have to be accommodated in residential neighborhoods. In reasonably dimensioned dead-end streets, it is likely that fire equipment must back up at least once because of cars parked in the cul-de-sac and because other emergency vehicles are on the scene. When fire trucks must reverse direction, they rely on the accompanying firefighters or police for guidance and encounter few maneuvering problems and little loss of time. In addition, many communities are beginning to purchase vehicles that fit the streets rather than design streets to meet the needs of particular vehicles.

Moving vans use dead-end streets infrequently and usually carry helpers to assist drivers in maneuvering, backing, and directing traffic around the van. On occasion, cars parked in the street must be moved for the van to get out of the traffic lanes. Because they are not associated with emergencies, moving vans need no special consideration.

Streets

Snow plowing should not be a ruling design consideration. Minor residential streets are cleared satisfactorily by equipment smaller than is generally appropriate for arterial streets and highways. In fact, snow removal on minor residential streets is often unnecessary except in heavy snow areas.

Garbage trucks, now often called refuse packers, usually operate once or twice a week within a residential area and travel from residence to residence at walking speeds. At these speeds and with the assistance of drivers' aides, backing movements should pose no problem. Some communities are using small loading vehicles for house-to-house refuse collection to permit more efficient use of expensive refuse-packer time. Turning requirements for refuse collection equipment is not a controlling design factor for residential streets.

Intersections

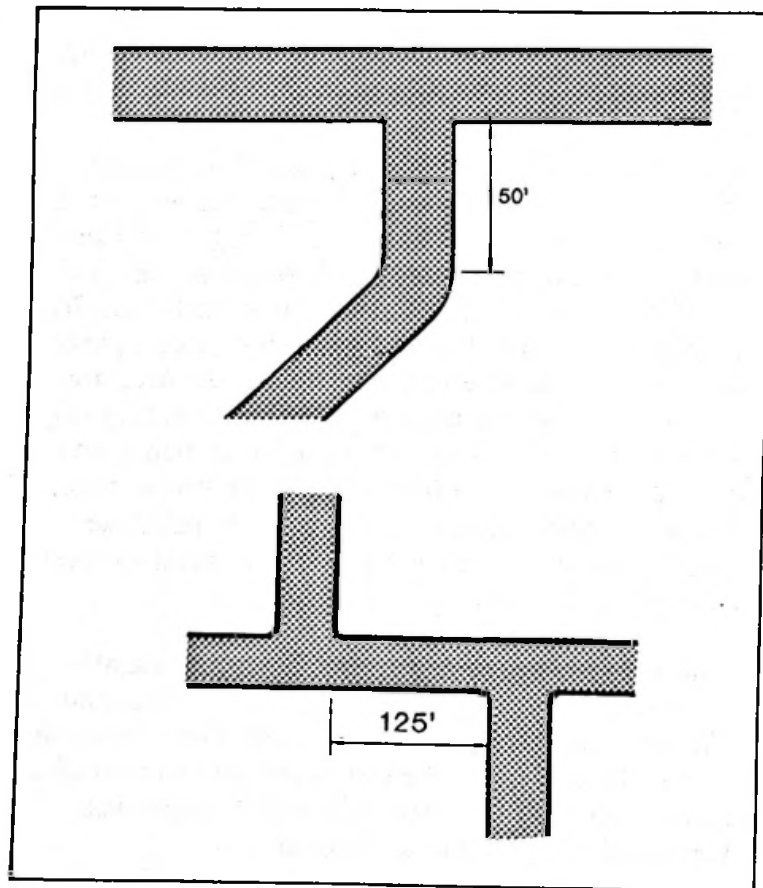

Intersections are points of conflict and potential hazard. Alignment and grade of intersecting streets should afford drivers a complete and unobstructed view of approaching traffic. Alignments should be as straight and flat as practical. The three-legged T-intersection provides an automatic right-of-way assignment, while four-legged intersections require a stop or yield sign to achieve control. In either case, 90-degree intersections are preferable to acute angles that create awkward turning movements. If local site conditions or land planning factors dictate intersections other than a right angle, the angle should be no less than 60 degrees.

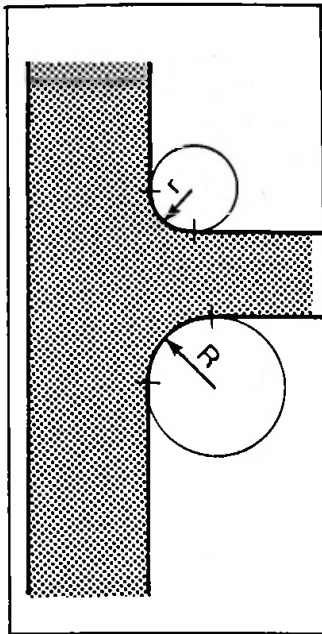

Curb radius

Opposing T-intersections should be spaced far enough apart that traffic passing from one intersection to the other does not back up and interfere with traffic movements at the next intersection. Generally, offsetting T-intersections by at least 125 feet on residential streets is considered adequate to prevent "corner cutting."

Curbs

A curb radius is a measure of the sharpness of the corner formed by two intersecting streets. As the curb radius increases, the intersection area (and paving cost) increases. In one large affordable housing subdivision in Arizona, reduction of curb radii resulted in considerable savings and allowed more efficient siting of the corner dwelling units. The larger the radius becomes, the more frequent are "rolling stops" and higher turning speeds. An inadequate curb radius results in driving over the curb.

Curbs are used to control drainage, protect pavement edges, and protect sidewalks and lawns from encroachment by vehicles. The general categories of curb are concrete barrier (or vertical) curb, concrete mountable (or roll-over) curb, and asphalt rolled curb. Asphalt rolled curbs are less costly to install but are less durable and, therefore, require more maintenance than do concrete curbs.

Suggested Ordinance Language

<i>Radius Range</i>	<i>Curb Radius (ft.)</i>		
	<i>Access-Subcollector</i>	<i>Subcollector-Collector</i>	<i>Collectors</i>
	15-20	25-30	25-30

Source: *Residential Streets, A Concept and Model Standards for Residential Streets*, Bucks County Planning Commission, Doylestown, PA, 1980.

Streets

The primary curb design factor is whether a curb is needed for residential streets. Throughout the nation, many community streets have been built without curbs and are performing satisfactorily. Drainage is usually provided by swales alongside the street and by culverts underneath driveways. Inverted crown streets can also be used to provide drainage in some climate conditions. Sufficient off-street parking or gravel shoulders should be provided if curbs are eliminated.

If curbs are considered necessary, the most cost-effective type is the mountable curb. Other than being slightly less expensive to install, mountable curbs allow economic driveway construction. Because driveway locations are seldom determined before curb installation, builders have flexibility in the timing and location of driveway construction. When the developer does not have predetermined driveway locations, vertical curbs must be removed and driveway aprons installed at all dwelling units. This curb "knock-out" and apron construction adds considerably to total curb and therefore housing costs.

Curbs are discussed in further detail in the next section of this manual.

Parking

Automobile parking poses a significant land use problem in subdivision planning. In the recent past, common practice provided for wide local streets, often capable of accommodating a row of parked cars on each side of the street in addition to two lanes of moving traffic. Such parking space has often been provided even though private driveways and other off-street parking can accommodate several cars. Good planning can reduce the heavy commitment of land to parking without sacrificing adequate accommodation of vehicles. Following are guidelines for parking:

- provide off-street parking areas whenever possible
- use common driveways
- design pavement thickness to meet actual parking load requirements rather than to satisfy general standards
- eliminate curbs and gutters in parking areas

- if curbs must be built, use roll curbs or other alternatives to standard requirements
- if street parking must be used, limit such parking to one side of the street
- use unpaved shoulders for parking to reduce road pavement width
- consider traditionally unused space such as the center of a cul-de-sac or a court for parking

Because about one-third of all American families own two or more cars, parking for residents is a major consideration in residential design. There are only two alternatives for parking: on street and off street.

On-Street Parking

Options for providing on-street parking include parking on both sides of the street, parking on one side only, and parking bays with no parking on the street. Parking lanes require either an eight-foot paved width or an equally wide retained-gravel shoulder. The latter option may have the advantage of reducing the rate of stormwater runoff. Gravel shoulders help create a natural or rural appearance but are dependent on sensitive landscaping to fulfill functional and aesthetic objectives. They also require careful design and construction to prevent excessive maintenance. Angle parking requires more moving lane space than does parallel parking and is generally considered more hazardous than parallel parking.

Off-Street Parking

Adequate off-street parking eliminates the need for parking lanes on the street. Off-street parking reduces accidents and keeps the street clear for snow plowing, if necessary. For these reasons, community planners should consider off-street parking that is accommodated by driveways, carports, garages, or, in high-density developments, parking lots. If off-street parking is planned, driveways should be long enough and wide enough to provide adequate space without impeding pedestrian use of sidewalks or streets.

Narrower street widths reduce both the direct costs of street construction and maintenance and the indirect costs of

Streets

unnecessary land use. Elimination of one or both parking lanes along as many streets as possible through the provision of off-street parking makes a major contribution to achieving these savings and keeping housing within the affordable range.

Detached units can often share a driveway, eliminating additional curb cuts and their associated costs. The width of a common driveway may vary according to the number of units served, but should generally be no wider than the usual width of a single driveway.

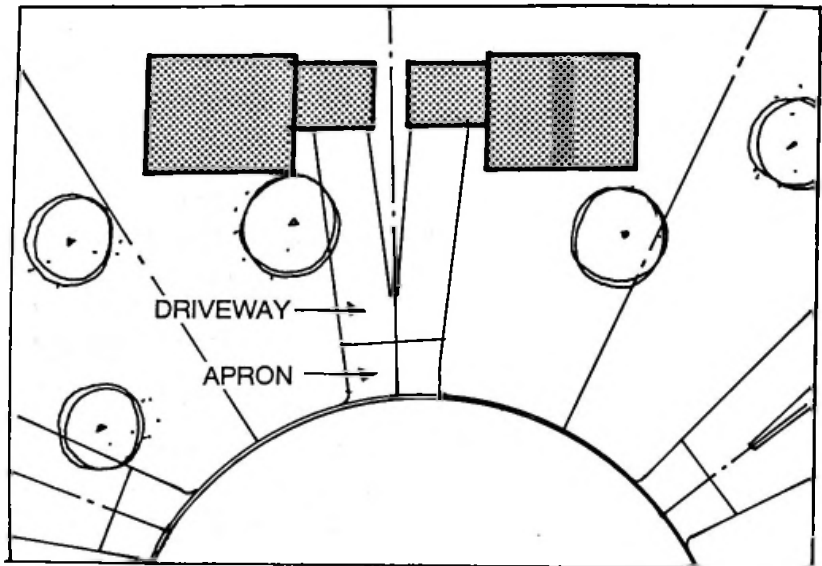

Common driveway

Increasingly important in residential planning is the accommodation of recreational vehicles and boat trailers. Travel and boat trailers and motor home parking should not be permitted on residential streets. Some communities also prohibit any RV parking that is visible from the street. As a result, some developments provide secure areas for RV storage and maintenance.

Parking Construction

Two significant variables in the construction cost of parking areas are pavement thickness and requirements for curbs and gutters. Although local requirements for pavement design

and curb and gutter construction usually do not apply to private driveways, many do apply to common parking areas.

Pavement thickness should be based on anticipated usage, with regard to both volume and loadings. Standards that apply to roads and highways are rarely appropriate for residential parking areas. Typical community standards for residential parking areas specify a minimum base of four to six inches. However, a two-inch base of crushed stone is frequently adequate. The nature and condition of the subsoil must be considered.

Another factor is whether the parking area will be used by heavy vehicles, notably trash trucks. Trash dumpsters can be placed to minimize the amount of pavement that may require reinforcement.

Rights-of-Way

Rights-of-way are publicly owned land on which street, sidewalks, curbs, and gutters are built. They often accommodate utilities such as water, sewer, and electrical service. The government body that owns the right-of-way grants a conditional right of use and passage to the public or such designated parties as utilities. Right-of-way land is not on the property tax rolls and generates no tax income. The process for determining right-of-way requirements should include consideration of needed facilities and their locations. If utilities are to be located under the street pavement, added right-of-way for utilities cannot be justified. Similarly, if sidewalks are not to be included as part of a residential development, expansion of the right-of-way width to accommodate sidewalks is not needed.

Jurisdictions routinely specify a minimum right-of-way width of 50 feet or greater, which comprises sufficient width for a 30- to 36-foot-wide roadway, with broad margins for sidewalks and utilities. Such specifications reflect a past era of lower land values. In today's environment, right-of-way widths should be subjected to rigorous review to ensure that they do not contribute needlessly to increased housing costs.

Streets

The right-of-way accommodates the roadway along with its associated shoulders, curbs, and gutters. Traditional designs often resulted in streets much wider than were necessary. This was done for the following reasons:

- detailed planning to relate road width to reasonable anticipated usage was usually not carried out
- substantial road capacity was routinely built to allow for unevaluated possibilities of "future growth"

The first step in reducing right-of-way width is substituting detailed traffic analysis and planning for general guidelines.

Other uses of rights-of-way, including sidewalks, placement of utilities, snow storage space, and planting strips, should be evaluated. One alternative is to accommodate uses other than roads with easements. If easements cannot be used for such applications, right-of-way requirements for other uses often can be reduced.

Rights-of-way should be only as wide as necessary for the street pavement and other facilities. Allowances for future street widening is unnecessary in well-planned neighborhoods that are designed to discourage through traffic on residential streets. Streets that are planned for future traffic routing should not be categorized or treated as residential streets.

Easements

Easements grant rights of passage through and/or use of privately owned property. In residential settings, the owners of easement land are homeowners, while the holder of the easement is the utility company or municipality. The municipality prescribes types and conditions of use for easements, as it does for rights-of-way. Easements provide the same access to utilities as do rights-of-way.

Easements provide legal maintenance access while making more land available for housing and placing more land on the tax rolls. For example, a 50-foot right-of-way for a 26-foot-wide street uses almost twice as much land for streets, utilities, and sidewalks than does an easement. If lots measure 50 feet by 120 feet (6,000 square feet), the above

example adds another 700 square feet per unit for the right-of-way. In a development containing 200 housing units, 140,000 square feet of land is taken off the tax rolls. If easements are used instead and lot sizes remain unchanged, the property might yield 23 additional units. Since front setback requirements are normally measured from edge of the right-of-way, lengths--and costs--of driveways, utility laterals, and individual unit walkways are reduced when easements are used.

Another option to reducing rights-of-way is to place sidewalks and bicycle paths on land owned in common by a community association. If combined with under-street utilities, the result is the elimination of all rights-of-way other than those than required for streets.

Use of easements as an alternative to rights-of-way provides benefits to each of the parties involved in residential development.

The municipality gains

- additional land on the tax rolls
- reduction in land for which it has maintenance responsibility

The builder gains

- more land to sell
- increased design flexibility

The homeowner gains

- more usable land
- lower home costs

CURBS AND GUTTERS

Introduction

Curbs and gutters convey rainfall into storm drainage systems (discussed in the next section) and define street edges. There are, however, less costly alternatives to the traditional vertical curb and gutter construction.

Following are guidelines for curbs and gutters:

- substitute grassy swales for curbs and gutters.
- where curbs are installed, build mountable curbs rather than vertical curbs
- reduce the width of concrete gutters or eliminate them entirely
- eliminate reverse-flow curbs and gutters in parking lots or replace them with asphalt curb, header curb, wheel stops, or integral curbs/sidewalks
- with concrete vertical curbs, use extruded construction rather than formwork

Swales

Grassy swales are depressed areas running parallel to the street that convey stormwater in lieu of curbs and gutters. The grading required to construct a swale can be completed during the grading of the surrounding lots or during final street grading. Therefore, cost savings are approximately equivalent to the cost of installing a curb and gutter.

In addition to providing savings in initial construction, swales offer continued savings in the form of lower long-term maintenance. Periodic flushing, replacement, or rehabilitation of pipes is eliminated. Swales within the public right-of-way are typically maintained by the homeowner and most swales can be graded to ensure easy mowing.

Where runoff is accommodated by a shallow swale, the depressions can be carried directly across driveways. Where a deeper depression is required for greater runoff capacity, concrete or metal conduits can be installed under driveways.

At street intersections, stormwater pipe can be installed under the street.

In addition to providing cost savings, swales allow for local retention of moisture from rainfall and melting snow as discussed in greater detail in the section on storm drainage systems.

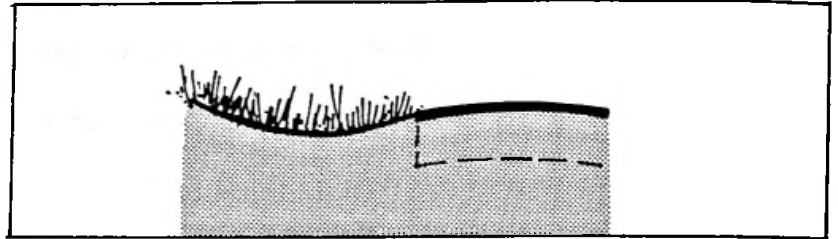

Grassy swale meets roadside without curb

Types of Curbs

The most common type of curb in urban residential settings is the vertical combination curb and gutter. A less costly alternative is the rolled curb, also called the roll, roll-over, or mountable curb. Roll curbs are typically six inches or less in height with a plane sloping face or well-rounded corners. The curbs' two- to three-inch radius allows vehicles to cross them with ease. They can be sized to meet local hydraulic demands. The slope across the face of the gutter and the height of the curb can be designed to meet projected stormwater capacity.

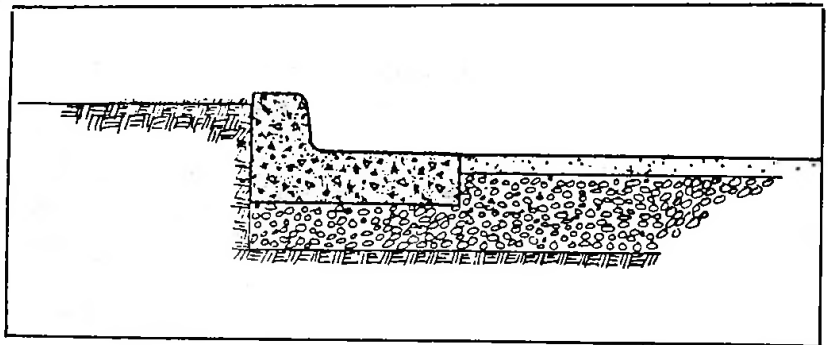

Vertical curb and gutter

In many instances, curbs are installed before the house type or lot is selected and well before driveway placement is

determined. Therefore, it is usually necessary to remove the vertical curb, install a curb cut for the driveway, and haul away the old curb. A roll curb eliminates these several steps and, based on the results of the Joint Venture for Affordable Housing Demonstration projects, can save approximately \$300 to \$450 per housing unit.

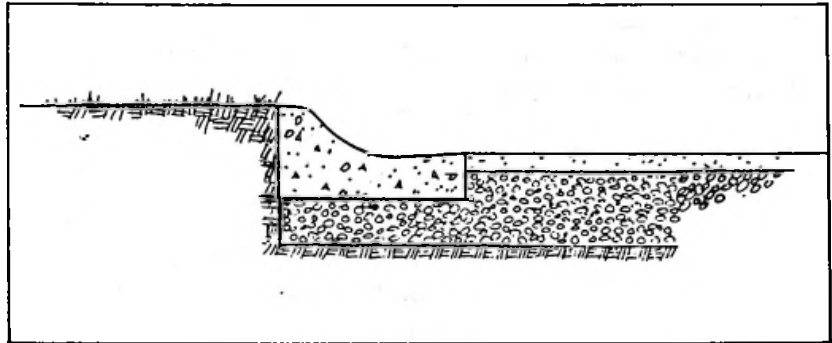

Mountable or roll curb

However, if vertical curbs are preferred, good planning can reduce the added cost of removing any curb. A simple method gaining popularity is to leave a space for the driveway and pour a separate entrance later. If possible, the driveway entrance should be installed during construction of the adjacent sidewalk to avoid added labor costs.

Gutters

Concrete gutters, 18 inches to 24 inches wide, are a standard requirement in many development specifications. In most areas, a 12-inch gutter is sufficient while in more arid regions gutters can be entirely eliminated by simply extending the asphalt surface to the shoulder or curb. Local weather data should be reviewed and gutters reduced in size or eliminated where rainfall rates warrant.

Curbs in Off-Street Parking Areas

Alternatives to vertical curbs in off-street parking areas include the following:

- elimination of curbs and gutters
- header curbs
- asphalt curb construction

Curbs and Gutters

- integral curb and sidewalk
- wheel stops

Combination curb and gutter can be eliminated in many parking lots by encouraging the use of sheet flows.

Much of the curb line in parking areas generally consists of reverse-flow gutters--that is, gutters that do not convey water as a conventional gutter does but simply divert water away from the curb. Such diversion is usually possible without a curb through proper grading of the parking lot surface.

Where curbs are required or desired, they can often be replaced with header curbs, asphalt curbs, or integral curb and sidewalk, especially in cases where a gutter is not warranted.

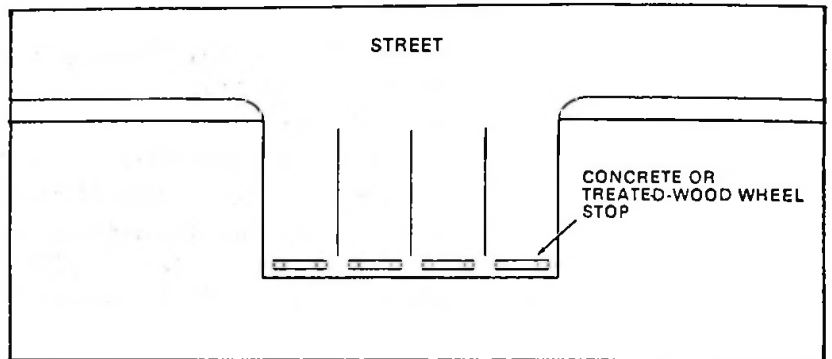

Wheel stops in parking bays

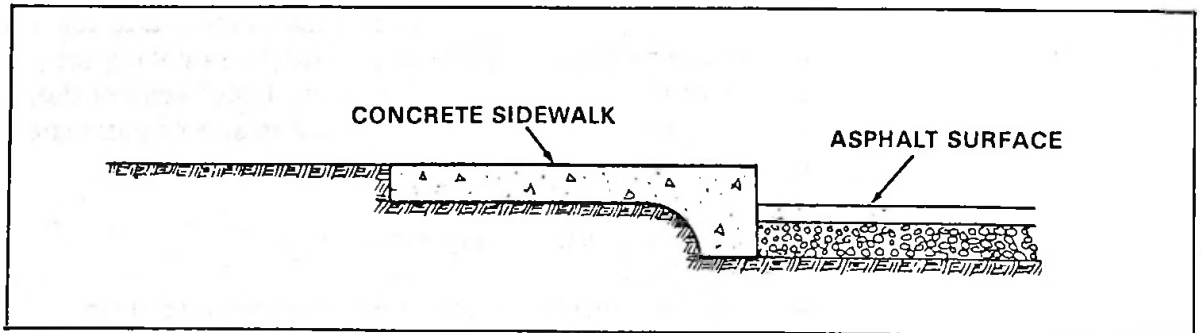

Integral curb/wheel stop/sidewalk

Wheel stops are a less expensive alternative to curbs that keep intact the psychological barrier provided by curbs.

Construction Methods

Installation of curbs and gutters has traditionally required labor-intensive formwork and preparation. Such construction methods have increasingly been replaced by extrusion or "slip form" techniques in which the operator, following a string line with a machine, "lays" the concrete out in its final form. This technique can be used to construct either a traditional curb or alternative types of rolled curbs. In areas where traditional formwork is still done, builders should check the availability of labor-saving alternatives.

Suggested Ordinance Language

Curb Requirements

<u>Street Frontages</u>	<u>Parking Provisions</u>	<u>Curb Required</u>
<i>Without residential lot frontage</i>	<i>None</i>	<i>No</i>
<i>With residential lot frontage</i>	<i>Off street</i>	<i>No</i>
<i>With residential lot frontage</i>	<i>On street</i>	<i>Yes</i>

Flexibility regarding curb type shall be permitted as long as the curb type accommodates the system of drainage proposed.

Exceptions

- (a) *The Municipal Engineer may require curbing for storm water management, to stabilize pavement edge, to delineate parking areas, 10 feet each side of drainage inlets, at intersections; at corners, and/or at tight radii.*
- (b) *Where curbing is not used, edge definition and stabilization shall be provided.*
- (c) *Where curbing is required, the requirement may be waived and shoulders and/or drainage swales used when it can be shown that:*
 - 1) *shoulders are required by state regulations; 2) soil or topography make the use of shoulders and/or drainage preferable; or 3) it is in the best interest of the community to preserve its rural character by using shoulders and/or drainage swales instead of curbs.*

Source: *Residential Streets, A Concept & Model Standards for Residential Streets*, Bucks County Planning Commission, 1980, & *The Subdivision & Site Plan Handbook*, Listokin & Walker, Rutgers, 1989.

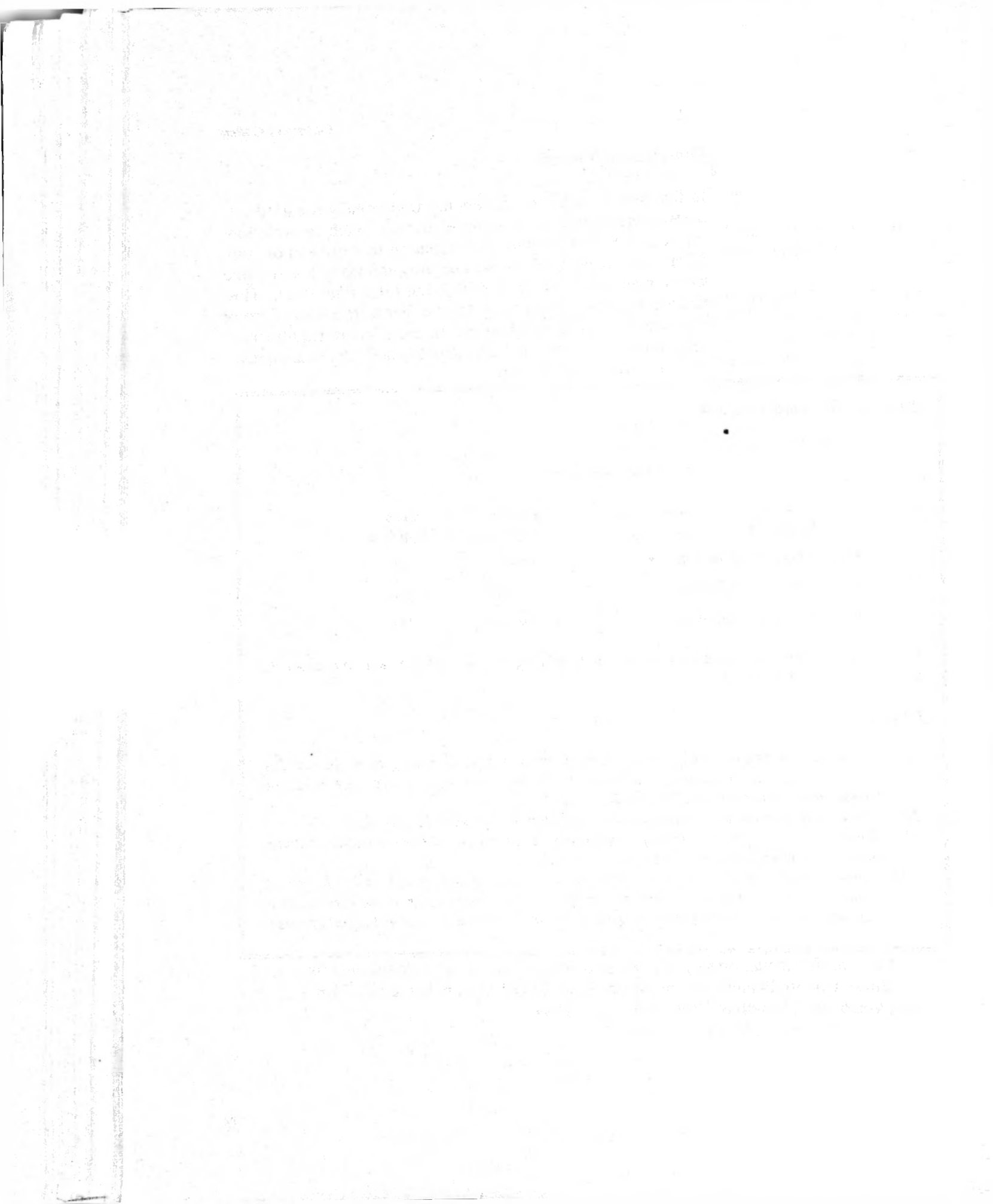

SIDEWALKS AND WALKWAYS

Introduction

Many local zoning ordinances and construction standards specify that sidewalks must be built on both sides of residential streets. This requirement was developed during an era of lower land and construction costs and should be reviewed in the context of today's higher costs.

Following are guidelines for sidewalks and walkways:

- construct sidewalks on one side rather than both sides of local streets, and consider elimination of sidewalks altogether on lightly traveled streets
- eliminate sidewalks along low-intensity dead-end streets and cul-de-sacs
- minimize the placement of homes along collector and higher-order streets, thereby reducing or eliminating the need for sidewalks on these streets
- replace infrequently used sidewalks along streets with pathways that link clusters of residences, bus stops, stores, playgrounds, and other community facilities
- if sidewalks are necessary, limit their width to three feet on local access streets
- consider using sidewalks integral with curbs

Sidewalks in Residential Areas

Local governments, builders, and homebuyers all benefit from cost savings that can be achieved in sidewalk construction. Builders and homebuyers save through lower construction costs, while local governments save through reductions in maintenance and replacement.

An increasing number of communities have dropped from their standards requirements for sidewalks in residential neighborhoods. Streets in residential areas generate insignificant amounts of pedestrian traffic and a low volume of vehicular traffic that travels at slow speeds.

Sidewalks and Walkways

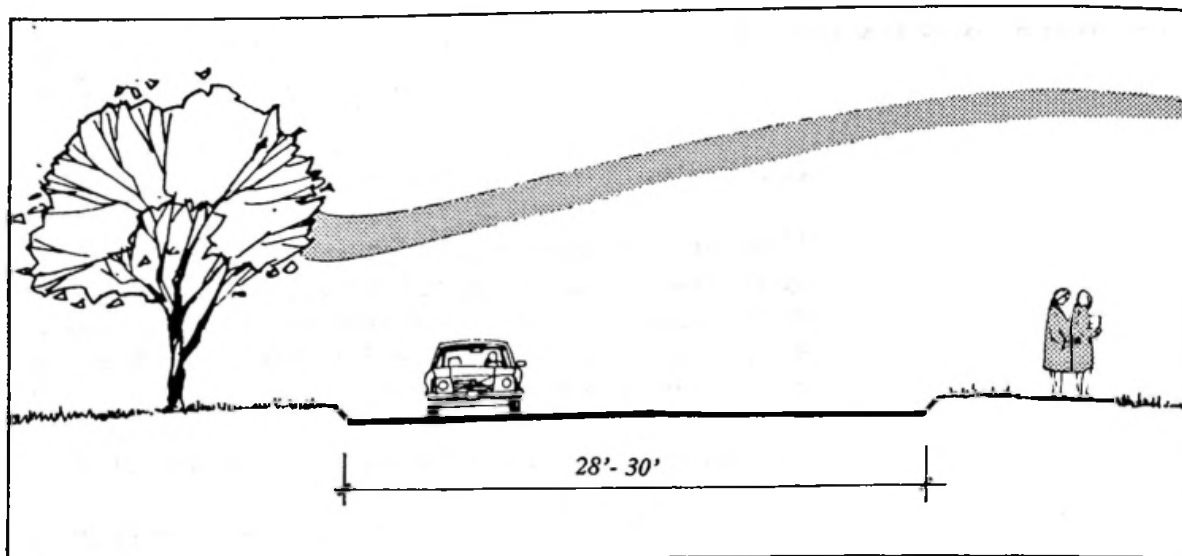

Single sidewalk along high-traffic street

On higher-order local streets and collector streets, safety is often cited as the rationale for building sidewalks on both sides of the street. However, in most cases, a single sidewalk will suffice. Communities should evaluate situations in which a single sidewalk is likely to generate substantial street crossing.

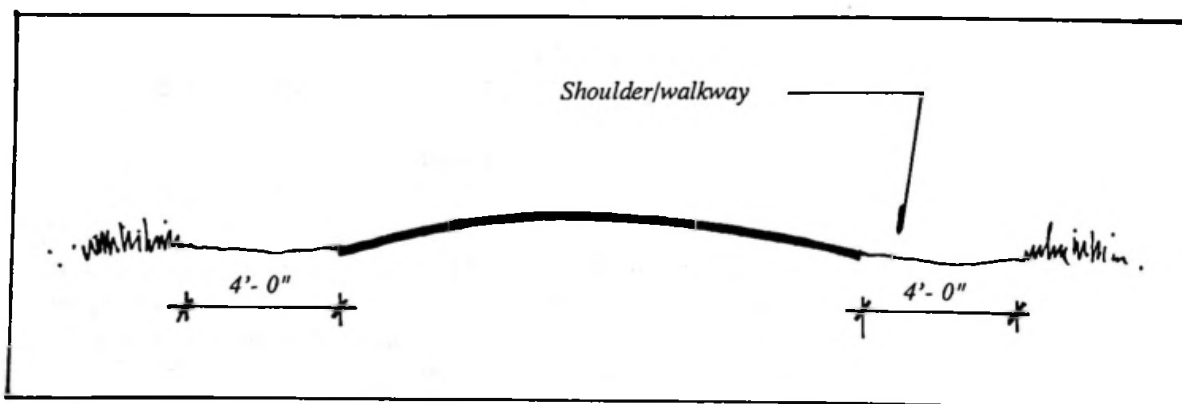

Combination roadside shoulder/walkway

Sidewalks along some higher-order streets can be eliminated completely if houses do not face such streets. Graded shoulders will be sufficient for the minimal amount of pedestrian traffic on many of these streets.

In planning for sidewalks and for pathways as discussed below, consideration should be given to such likely pedestrian destinations as bus stops, playgrounds, and commercial areas. Accommodation of significant foot traffic along standard walking routes is more important than accommodation of occasional and casual traffic between and among homes.

Pathways and Walkways

Concrete, asphalt, or gravel paths between and among strategic locations offer cost-effective alternatives to sidewalks and eliminate possible safety hazards to pedestrians. By incorporating pathway layouts into the layout and planning of subdivisions, walking access can be provided between groups of residences and such facilities as parks, community centers, and shopping centers. The paths and walkways can pass over easements that constitute part of the total subdivision plan. Townhouse and cluster developments lend themselves well to this type of integrated planning.

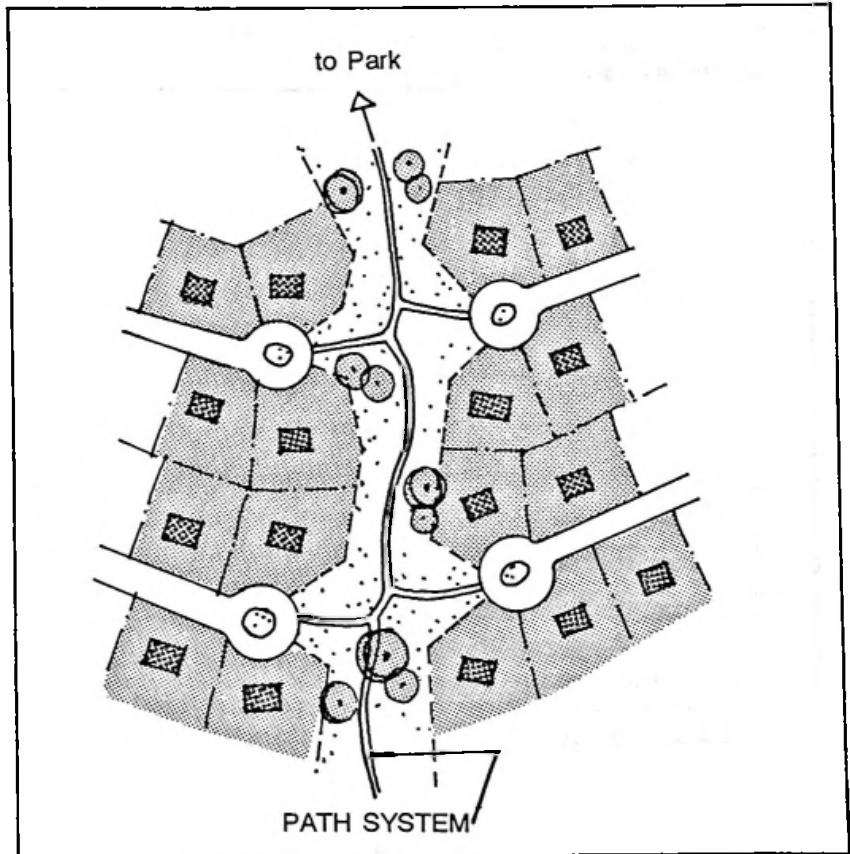

Pathways placement

Sidewalks and Walkways

Dimensions and Construction

Sidewalk widths have a direct impact on construction cost and, often, an indirect effect on costs through their influence on right-of-way widths. Many communities specify sidewalk widths as great as five to seven feet when three feet is a reasonable width for pedestrian travel in residential areas. On these infrequently used walkways, a pedestrian's occasional need to step off the sidewalk to let another pedestrian pass does not justify the cost of greater width.

An integral curb and sidewalk combines two separate construction processes into a single step. One edge of the sidewalk is "thickened" and its die doubles as a curb. This type of sidewalk should be at least four feet wide.

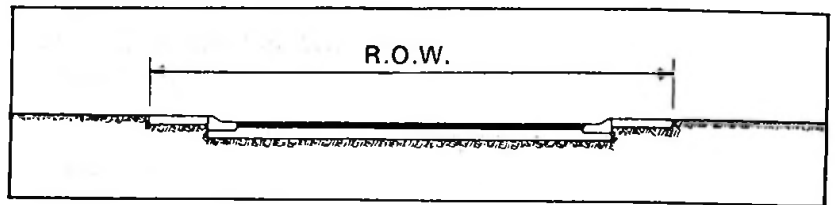

Integral curb and sidewalk

*Suggested Ordinance Language**Sidewalk Requirements*

<i>Minimum Width Street Description</i>	<i>Sidewalk Requirement (if installed)</i>	
<i>(a) Residential Access</i>		
<i>Low intensity</i>	<i>Optional</i>	<i>3</i>
<i>Medium intensity</i>	<i>Optional</i>	<i>3</i>
<i>High intensity</i>		
<i>- off-street parking</i>	<i>Optional</i>	<i>3</i>
<i>- on-street parking</i>	<i>One side only</i>	<i>3</i>
<i>(b) Residential Subcollector</i>		
<i>Low intensity</i>	<i>Optional</i>	<i>4</i>
<i>Medium intensity</i>		
<i>- off-street parking</i>	<i>Optional</i>	<i>4</i>
<i>- on-street parking on one side</i>	<i>One side only</i>	<i>4</i>
<i>- on-street parking on both sides</i>	<i>One each side</i>	<i>4</i>
<i>High intensity</i>		
<i>- off-street parking</i>	<i>One side only</i>	<i>4</i>
<i>- on-street parking on one side</i>	<i>One side only</i>	<i>4</i>
<i>- on-street parking on both sides</i>	<i>One each side</i>	<i>4</i>
<i>(c) Residential Collector</i>		
<i>All intensities with no residences</i>	<i>Optional</i>	<i>4</i>
<i>All intensities with residences</i>	<i>One each side</i>	<i>4</i>
<i>(d) Special</i>		
<i>Rural residential lanes</i>	<i>Optional</i>	<i>3</i>
<i>Alleys</i>	<i>Optional</i>	<i>3</i>

Exceptions:

1) Graded shoulders may be substituted for sidewalks. 2) Where optional, sidewalks may be required if near pedestrian generators to continue existing sidewalks, to link areas, or for future development as indicated on applicable master plans. 3) At the discretion of the appropriate municipal authority, walkways directing pedestrian traffic to common areas, bus stops, commercial facilities, etc., that are not located alongside streets shall be considered an acceptable alternative.

Source: *The Subdivision and Site Plan Handbook*, Listokin, Walker, Rutgers, The State Univ. of NJ., 1989, & *Challenge and Response, Vol. I, Affordable Land Develop.*, NAHB National Research Center, 1987.

Department of Education

Division of Vocational Education

Form No. 1

June 1954

State of New York

County of ...

Name of Applicant

Address

City

State

Age

Occupation

Education

Experience

References

Remarks

Signature

Date

Signature

Date

Signature

Date

Signature

Date

Signature

Date

Signature

Date

Signature

Date

Signature

Date

Signature

Date

Signature

Date

Signature

Date

Signature

Date

Signature

Date

STORM DRAINAGE SYSTEMS**Introduction**

The stormwater drainage system is a single system with two purposes: the control of stormwater runoff to prevent or minimize damage to property and physical injury or loss of life that may occur during a major, infrequent storm; and the control of stormwater to eliminate or minimize inconvenience or disruption of activity as a result of runoff from frequently occurring rainfall or less significant storms.⁴

Gutters, which are discussed in the previous section, are just one component of the complete storm drainage system. However, important economies can be achieved in the construction of entire storm drainage systems.

Following are guidelines for storm drainage systems:

- use performance requirements in place of prescriptive standards in all components of storm drainage design
- consider detention/retention basins, especially when regional management is preferred
- consider precast structures if available from local suppliers
- reduce the use of manholes and inlets by increasing spacings between structures or by replacing them with curved pipe sections, "tees," and "wyes" where appropriate

Traditional stormwater systems were usually "closed"--that is, once water entered the system, it passed through nonporous pipes and channels, sometimes for substantial distances, until it was finally discharged into a moving stream or river. More recently, the advisability of removing a significant portion of runoff from local areas that experience precipitation has increasingly come into question. Consequences can include inadequate recharge of groundwater supplies; increased

⁴ *Residential Storm Water Management, Objectives, Principles & Design Considerations*, Urban Land Institute, American Society of Civil Engineers, and National Association of Home Builders, 1975.

potential for contamination of groundwater; soil subsidence such as the formation of sinkholes that have occurred in central Florida; and downstream flooding.

Modern systems increasingly emphasize retention of rainfall in the local area where it falls. Parts of the conveyance system can be left "open," substituting grassy swales and natural drainage for closed piping. Detention and/or retention basins can also accommodate excess stormwater, enabling the gradual recharge of local groundwater supplies.

Open portions of drainage systems cost less than equivalent closed piping. Environmental considerations and cost savings therefore go hand in hand. Additional savings can be achieved through regional stormwater management programs that serve the entire drainage basin or several specific sites within a basin. Regional control of stormwater generally requires less construction by developers, while the local jurisdiction achieves savings in operation and management costs. Improved efficiency is another benefit over individual site controls as the need for "piecemeal" planning can be reduced.

Design Storm Requirement

A 10-year design storm is the typical standard for the "minor" stormwater system in a residential development. However, major channels or culverts with large contributing areas require special consideration. Design storm frequency is based on convenience and economics. A community decides how much to pay to ensure against the possibility of flooding. The merits of each proposed site plan must be considered as each site adapts differently to various designs. Performance requirements, which generally encourage innovative and less costly alternatives, should be used over prescriptive standards.

Detention/Retention

Two effective methods for carrying excessive stormwater are detention/retention basins and "overland relief." Detention/retention facilities can take a variety of forms. Artificial lakes and subsurface absorption are two of the more popular systems. Although each has its own advantages and

disadvantages, both achieve the intended objective of effective stormwater management. Lakes contribute to aesthetic value but require more land area. Soil absorption systems can be installed on "tighter" sites but are limited by the capacity of the soil to accept the stormwater.

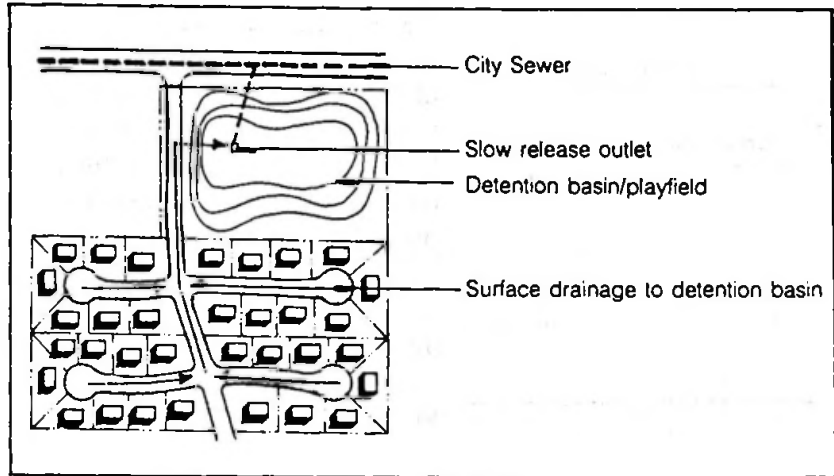

Retention/Detention

Overland Relief

The size of culverts and open concrete channels can be reduced by grading the surrounding land to direct stormwater via an overland path to the downstream stormwater system when runoff exceeds the design storm. Grassy swales provide overland relief in a residential neighborhood. Larger "flood banks" are used in major drainage areas.

Overland relief

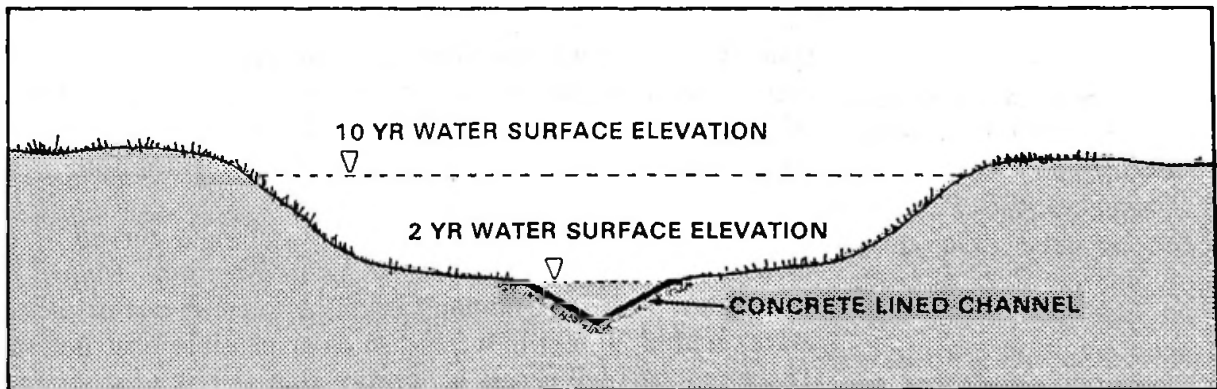

Storm Drainage Systems

Materials

In recent years, plastic pipe has been introduced as an alternative to traditional corrugated metal pipe (CMP) and reinforced concrete pipe (RCP). Polyvinyl chloride (PVC) and polybutylene (PB) exhibit resistance to corrosion. PVC, a relatively inexpensive plastic, can be installed throughout most of the "minor" storm drainage system. PB is manufactured in sizes small enough for water supply systems, large enough for highway culverts, and in most sizes in between, usually in a corrugated configuration that provides appropriate structural properties. Due to their relatively light weight, PVC and PB pipes do not generally require special equipment for placement in the trench. Choice of materials should be made on the basis of first cost and long-term durability.

Stormwater Structures

Components of a sewer system--manholes, sewers, inlet and outlet structures--must be examined for possible cost savings in installation methods, choice of materials, and use of new designs. Where available, precast manholes and inlets generally provide a less costly alternative to labor-intensive, site-built structures.

Manholes/Inlets

An average of \$1,000 to \$1,500 can be saved by eliminating a single manhole, depending on depth and local cost factors. Although many communities allow manholes or inlets to be spaced a maximum of 600 to 800 feet apart, some standards limit maximum spacings to as little as 200 feet. These shorter spacings are carry-overs from an era when clean-out capabilities and construction techniques were inferior to those of today. Officials must periodically review such standards to encourage state-of-the-art installation and construction.

Manholes can also be eliminated by installing a curved section of pipe at nonabrupt changes in direction. Many communities also recommend installing a clean-out or other access within 50 feet of a bend to clear possible obstructions. The need for such access is questionable as risk of stoppage in the curved storm sewer alignment is minimal.

Manholes can be eliminated where smaller pipes join larger storm "mains." For example, a prefabricated "tee" or "wye" section can join a building roof drain (downspout) to the public storm drain, thereby avoiding the added cost of a manhole.

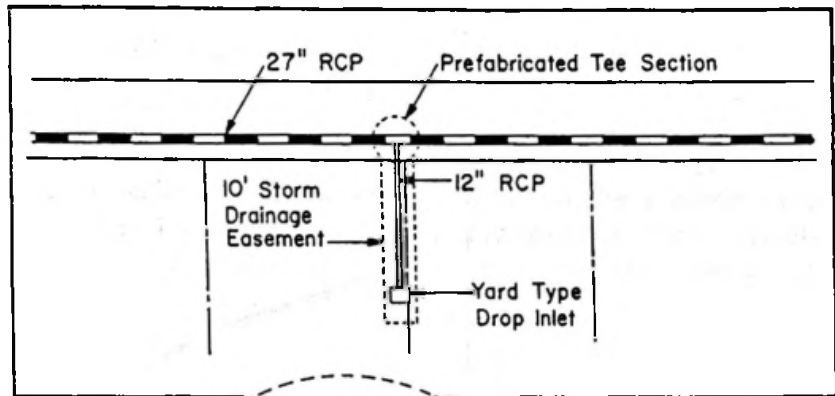

Prefabricated tee section

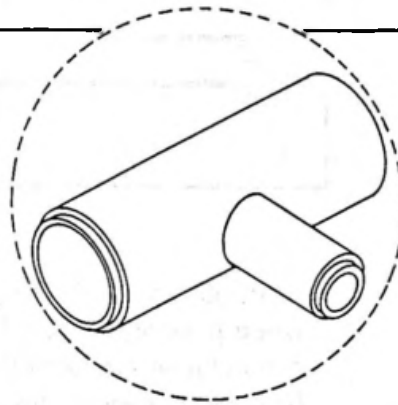

Endwall at pipe outlet

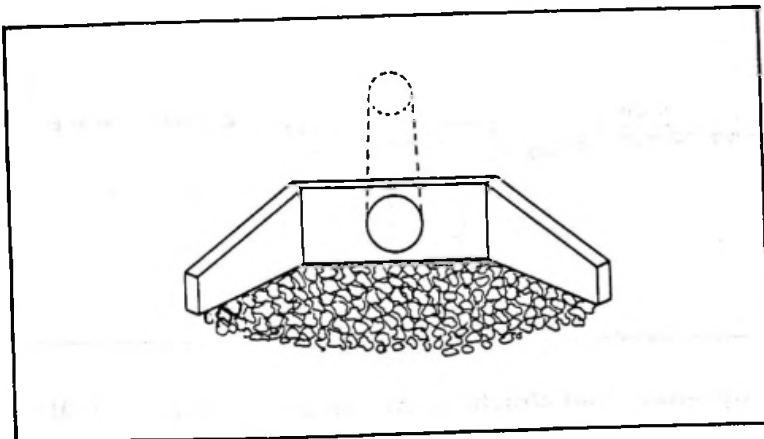

Endwalls, commonly installed at the end of a drainage pipe, can also be eliminated. With proper grading at the terminal end of the pipe, a flared end section will provide the needed transition at a much lower cost than an endwall.

Flared end section

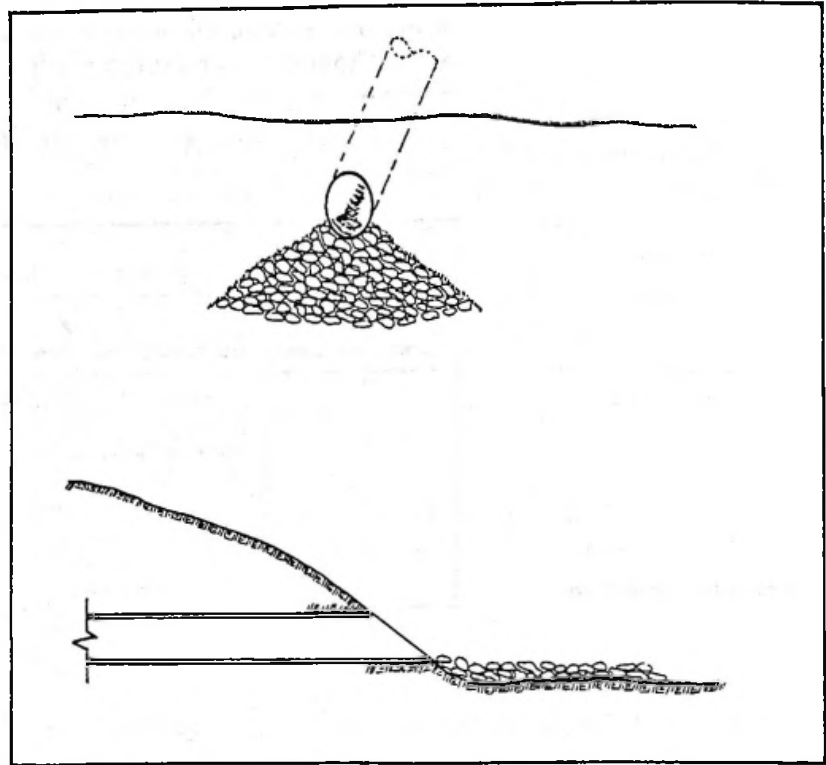

Multiple use of drainage structures should be encouraged when possible. A yard inlet, combined with a curb-type inlet, can achieve greater efficiency at less cost, and receive runoff from two or more directions.

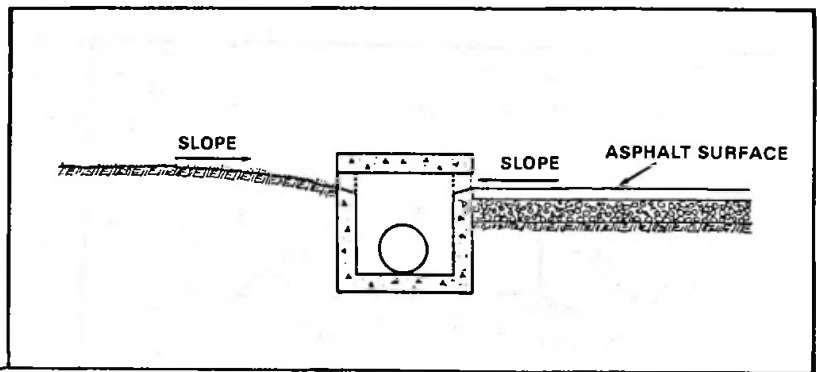

Combination curb/yard inlet

In some cases, inlet structures can be completely eliminated and replaced with flared end sections. If the surrounding

area is graded properly, an end section can be used as an inlet in place of a drop-type structure. Since the cost of an end section is similar to that of a standard section of pipe, overall savings would be equivalent to the cost of any eliminated inlet structure.

Inlet/Outlet Controls

Rip-rap, stone, or other erosion controls can often be replaced with one of the commercially available fabrics designed for soil stabilization. The fabric is placed at the end of the channel or pipe after the area has been graded and seeded. Fabrics can be installed at less cost than concrete or stone erosion controls and contribute to a more attractive site.

1870

As a sign of the times, the people of the United States are beginning to feel the effects of the war in Europe. The price of wheat has risen to a point where it is no longer profitable to export it to Europe. The price of cotton has also risen to a point where it is no longer profitable to export it to Europe. The price of sugar has also risen to a point where it is no longer profitable to export it to Europe. The price of other commodities has also risen to a point where it is no longer profitable to export them to Europe.

The price of wheat has risen to a point where it is no longer profitable to export it to Europe. The price of cotton has also risen to a point where it is no longer profitable to export it to Europe. The price of sugar has also risen to a point where it is no longer profitable to export it to Europe. The price of other commodities has also risen to a point where it is no longer profitable to export them to Europe.

SANITARY SEWERS

Introduction

Various sanitary sewer system alternatives are available to communities. Following are guidelines for sanitary sewers:

- use curvilinear sewers where feasible
- increase maximum manhole spacing
- use cleanouts as an alternative to manholes for maintenance
- use the least expensive, appropriate material
- when appropriate, use inside drop connections
- design sewer pipe size and slope to meet the need
- use television inspection procedures
- use common laterals

Manholes, Curvilinear Sewers, Cleanouts

Requiring fewer manholes, encouraging curvilinear sewer designs, and allowing use of cleanouts can save money for developers, local governments, and homebuyers. Curvilinear sewers reduce the total length of sewer pipe, but the greater savings accrue from a reduction of manholes at \$1,000 to \$1,500 each. Hydraulic performance within a sewer is not adversely affected by the curved sections.

Installation of large-diameter curvilinear sanitary sewers is recognized as an acceptable practice in many communities⁵. Advantages include the following:

- elimination of manholes at each change in direction
- placement of sewers parallel to or on the centerline of curved streets
- easier avoidance of other utilities
- location of manholes away from street intersections
- conforming with topographic contours for desired sewer alignment

⁵ *Gravity Sanitary Sewer Design and Construction*, American Society of Civil Engineers and Water Pollution Control Federation, 1982.

Sanitary Sewers

Rigid pipe can be curved by slight deflections of pipe joints from normal straight positions. The radius of curvature is a function of the allowable deflection angle per pipe joint and depends on the pipe material, jointing technique, and pipe size. An alternative to deflection of straight rigid pipe is radius sewer pipe--sometimes called mitered or beveled pipe--which is manufactured with the proper deflection angle built into the joint. In either case, it is important to follow pipe manufacturers' specifications.

Flexible sewer pipe can be installed on a curve by controlled bending of the pipe and by slight deflection of the pipe joint. As with rigid pipe, pipe manufactures' specifications must be followed.

In addition to curving pipe horizontally, some sanitary sewer pipe can be curved vertically as long as proper bedding is maintained. This technique can result in elimination of drop manholes and/or less trenching.

Straight versus curved sewer

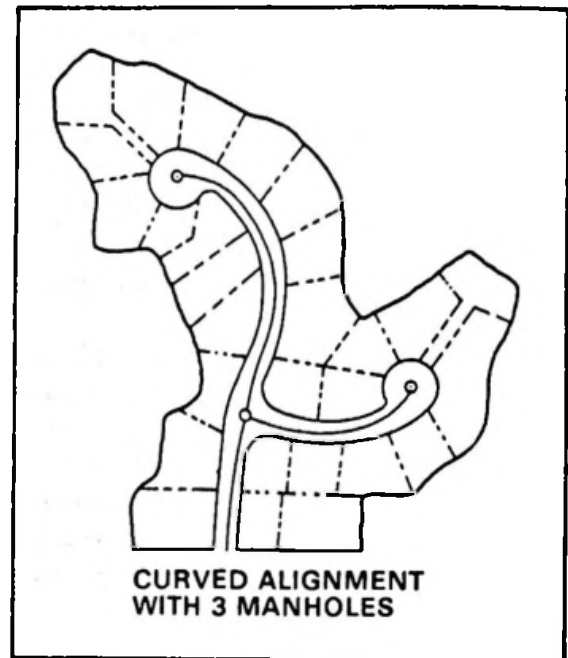
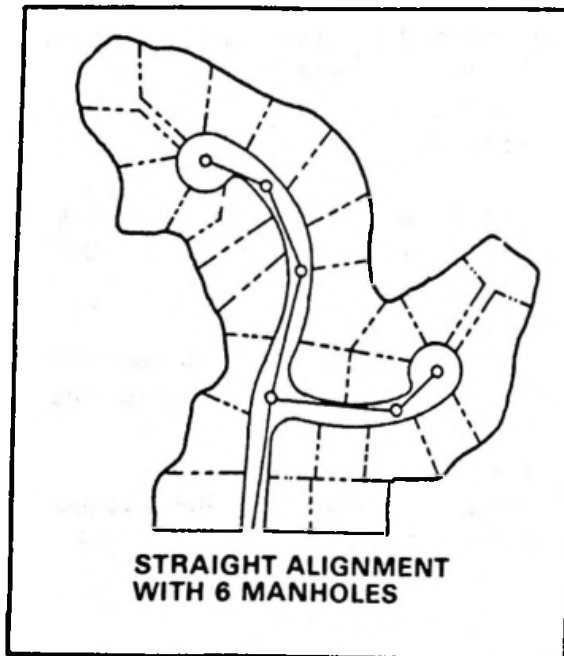

Suggested Ordinance Language

Curved sanitary sewers: Design and installation of sanitary sewers laid on curves is an acceptable practice provided that such sewers are installed according to pipe manufacturers' standards and in compliance with accepted engineering practices.

Source: *Gravity Sanitary Sewer Design and Construction*, American Society of Civil Engineers and Water Pollution Control Federation, 1982.

Although many communities require manholes to be spaced at a maximum of 200 to 400 feet, many now permit spacings in excess of 600 feet due to improved methods of maintenance and construction and innovations in clean-out equipment. For example, flush trucks capable of cleaning sewer lines 600 to 800 feet in length are now standard equipment for many public works departments.

Suggested Ordinance Language

Sanitary Sewer Manhole Spacing and Location: Manholes shall be spaced at the maximum distance of [600 feet] [insert the distance that can be cleaned with available cleanout equipment and that complies with the recommendations of the equipment manufacturer]. Manholes shall be located at junctions of sanitary sewer lines and at changes in grade or alignment except in curved alignments. Manholes shall be placed at locations that provide ready access for preventive maintenance and emergency service. Manholes shall *not* be placed in any low area where a concentrated flow of water over the manhole might cause excessive inflow. Manholes shall be located as near as practical to the centerline of streets and/or alleys. Avoid placement within street intersections except when necessary for present or future sewer line junctions.

Source: *Gravity Sanitary Sewer Design and Construction*, American Society of Civil Engineers and Water Pollution Control Federation, 1982.

Sanitary Sewers

Cleanouts

Cleanouts can be provided in lieu of manholes along both curvilinear and straight runs. Cleanouts can also be installed at a much lower cost than a manhole at the terminal end of the sewer line. They offer a cost-effective alternative in flood-prone areas or in areas of high water tables owing to lower costs and better protection against infiltration.

Cleanout standpipe

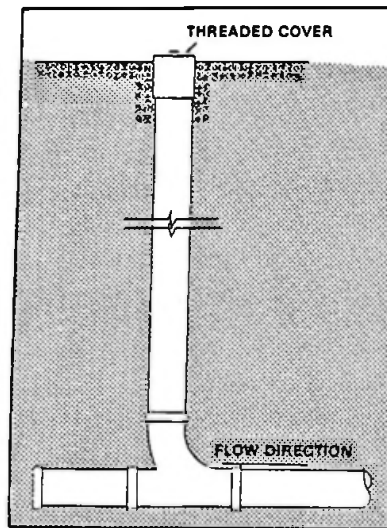

Drop Manholes

Drop manholes are often installed at changes in vertical alignment of sewer lines. They can, however, be the source of maintenance and cleanout problems. The abrupt change in direction of flow creates an opportunity for solid material to lodge and cause stoppage. Therefore, drop manholes should be used only when it is not economically practical to steepen the incoming sewer. Some engineers design curved sewer pipe to make vertical alignment adjustments. When significant elevation differences between the influent and effluent pipes cannot be otherwise accommodated, drop manholes must be used.

Many localities require an outside drop connection to convey wastewater across an elevation drop, a costly solution requiring added piping and concrete blocking. An inside drop connection is less costly because it requires less material, is

easier to install, reduces stress at the connection, and needs less excavation and backfill.

Outside drop inlet

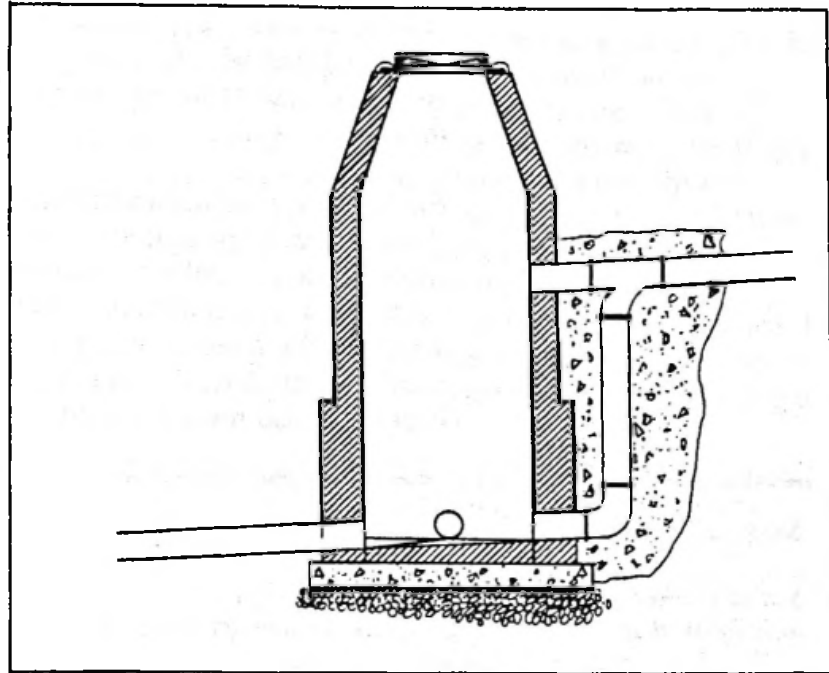

Inside drop inlet

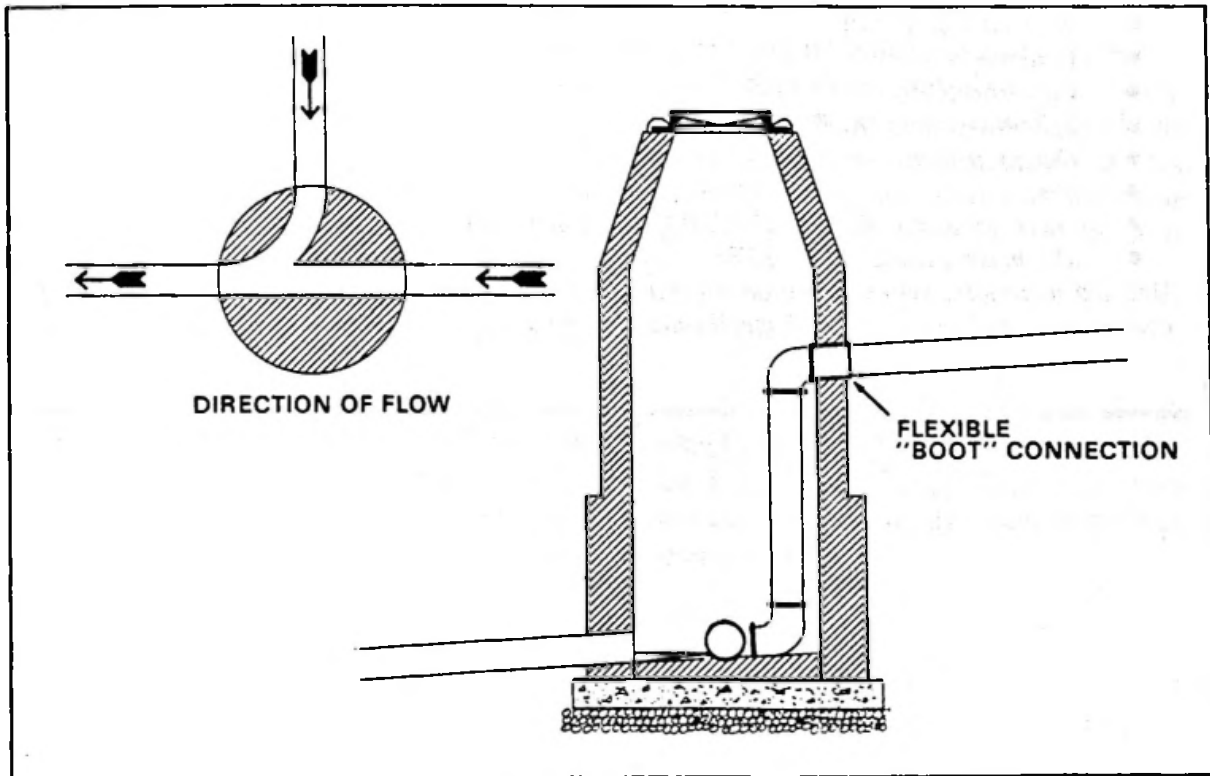

Sanitary Sewers

Pipe Materials

Sanitary sewer pipe materials can be roughly classified as rigid or flexible. For affordable housing, the least costly approach that will perform satisfactorily should be considered. Restricted use of newer materials limits competition and invariably increases cost.

Each of the pipe materials has advantages and disadvantages. Plastic pipe is being used in an increasing number of communities, sometimes offering reductions in materials, installation, and replacement/maintenance costs. If the entire length of the pipe, including joints, is supported by the bedding materials, the pipe is secure. Clean, carefully placed backfill is also recommended.

Suggested Ordinance Language

Sanitary sewer pipe materials. *Sanitary sewer pipe materials, fittings, and jointing materials and techniques shall conform to the standards and specifications of the appropriate agency (ASTM, ANSI, AWWA) for use in sanitary sewer systems and shall consist of, but not be limited to, any of the following:*

- *Vitrified clay (VCP)*
- *Concrete*
- *Cast iron (CIP)*
- *Asbestos-cement (ACP)*
- *Ductile iron*
- *Steel*
- *Thermoplastic (ABS, PE, PVC, PB, ABS composite)*
- *Thermoset plastic (RPM, RTR)*

Unlisted materials, systems, and/or techniques shall be acceptable for use upon demonstrated conformance with standards and specifications of the appropriate standards writing agency.

Source: *Gravity Sanitary Sewer Design and Construction*, American Society of Civil Engineers and Water Pollution Control Board, 1982.

Design Criteria

Communities are encouraged to develop a master plan for sanitary sewer systems. Sewer extensions should be coordinated with that master plan to ensure efficient, integrated systems. Community standards often arbitrarily require a minimum eight-inch-diameter pipe. In many instances, especially on cul-de-sacs, dead-ends, and other areas where the sewer serves only a few houses, smaller pipes of four- or six-inch diameter provide better service because of faster flow. Larger pipe sizes may be detrimental since they could promote deposition of solids at low flows. A three-inch house lateral is generally sufficient for a single dwelling unit.

Sizing criteria should be evaluated to reflect actual conditions. In the past, 100 gallons per capita per day (gpcd) was considered the standard design flow from a dwelling. However, researchers have shown that 40 to 50 gpcd more accurately reflects typical average flows.

An "across the board" minimum slope cannot be applied for all pipe. Sanitary sewers are designed on velocity considerations with a minimum velocity of two feet per second (fps) to eliminate deposition and a maximum of 10 fps to prevent scouring. The minimum slope sewer should not be an arbitrary standard but should be determined for a specific site and for particular pipe materials. Flatter sloped sewers reduce trenching depth, a critical factor where bedrock or other obstacles exist.

Inspection

Television cameras can locate problems with a higher degree of accuracy than a visual inspection. If combined with an effective maintenance program, television inspections help to ensure quality construction and indirectly result in savings in future repairs or replacement.

Sanitary Sewers

Common Laterals

Multiple connections to a common sewer lateral

Common laterals can be used to connect the public sewer to more than one house, reducing total trench length, quantity of materials, and cost.

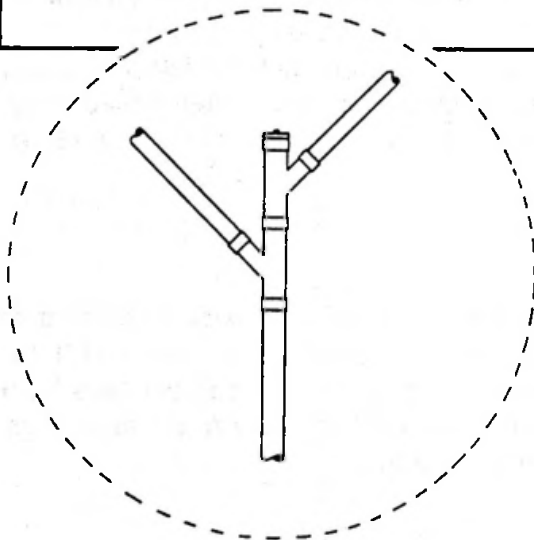
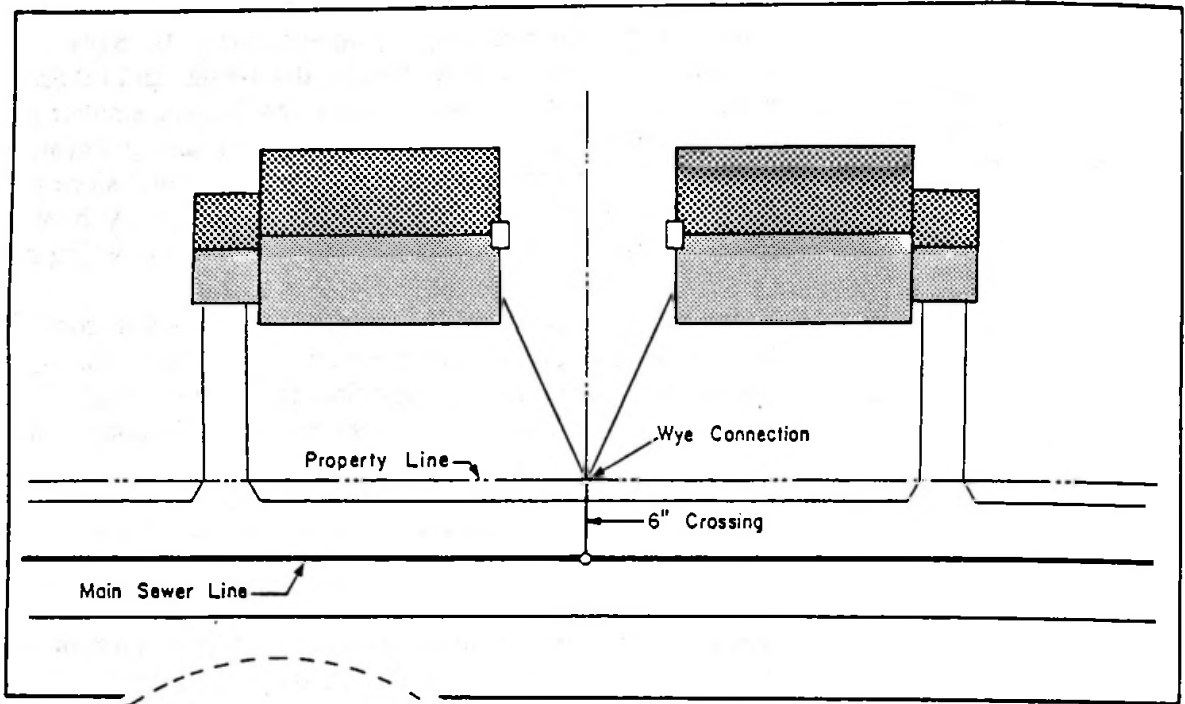

Wye Connection Detail

Two adjoining lots can be served by one lateral installed along the common property line with an easement dedicated to ensure access for maintenance and/or replacement. A standard "wye" fitting is installed at the junction of the individual building drains. Pipe length is decreased by almost 50 percent since every other lateral is eliminated.

Clusters and townhouses adapt well to common laterals when three or more units are connected to a single line. In any application of common sewer connections, benefits increase as the distance from buildings to public sewer increases.

WATER SUPPLY

Introduction

Alternatives to traditional standards, materials, and procedures used in residential water supply systems are often more cost-effective.

Following are guidelines for water supply systems:

- consider alternative materials for water mains and service pipes
- use multiple connections to one common service where feasible
- size water distribution pipes to meet the projected need
- substitute blow-off mechanisms for some fire hydrants
- consider alternative meter arrangements

Water Mains

For affordable housing, it is important to analyze installed costs and anticipated life cycle costs for maintenance and replacement of water mains. Traditionally, pressure water pipe has been constructed of concrete, vitrified clay, lead, ductile iron, cast iron, and asbestos-cement. The newest material is plastic, most often in the form of polyvinyl chloride (PVC) or polybutylene (PB). It has performed as well as many of the more traditional materials in many applications.

Plastic pipe is relatively light weight, easy to install, and resistant to corrosion. Most sizes of plastic pipe can be installed without using the expensive machinery normally required to lower the pipe into a trench. Plastic pipe's relatively long lengths are easily balanced against its lighter per unit weight. PVC does not require complicated mechanical or glued joints. The bell and O-ring joints of standard PVC water pipe are wedged into place, saving material and labor costs.

Water Supply

Water Service

An alternative to relatively expensive copper tubing for service lines is plastic tubing, usually manufactured from polyethylene (PE) or polybutylene (PB). Although local acceptance of plastic has been a slow process, the major model plumbing codes recognize both plastic materials. Available from most local suppliers, PB and PE have been rated at pressures well above those encountered in public water systems. Plastic tubing is flexible, lightweight, and easily joined with standard fittings. The relatively long lengths of flexible PB tubing ensure that the number of joints will generally be limited to those at the main and the meter.

Connections

Saddle-type connections can be eliminated where a service line taps into the water main. A corporation stop assembly, used when tapping into ductile iron pipe, provides a complete, tight-fitting connection without the saddle. (The saddle adds \$20 to \$30 per tap, depending on local factors.) Crimping of tubing, especially near the tap, can be avoided by bedding the area within a foot or two of the connection with a local aggregate.

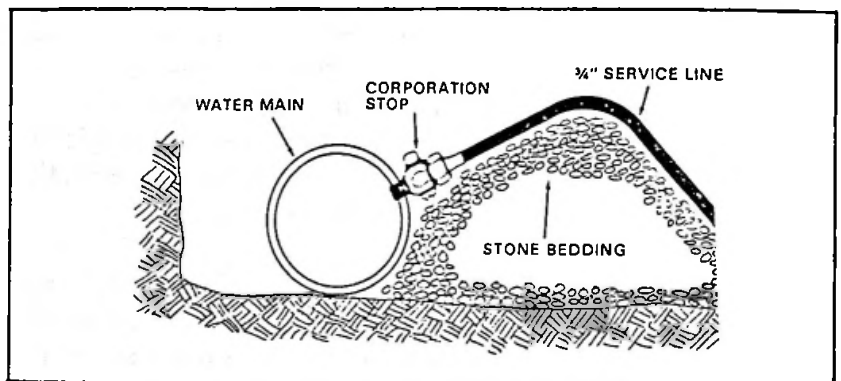

*Service line connection
to water main*

Multiple Connections

Communities should reevaluate standards that require a separate tap for each residence. Tap-in costs can be reduced significantly by branching off a tap to serve more than one building or home. Multiple connections to one common

service are frequently used with no adverse impact on performance.

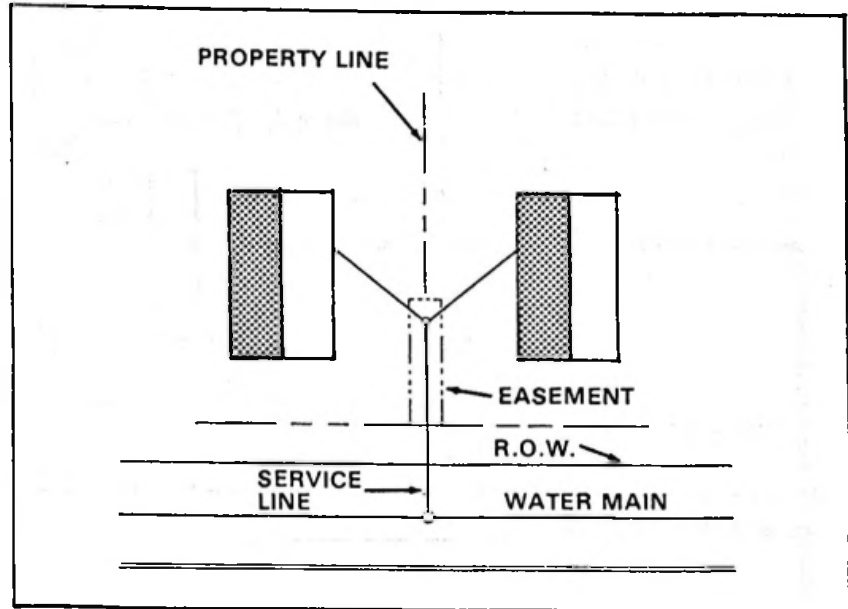

Common service line

A single water service can be installed along the common property line of adjoining lots. A standard "wye" or "tee" is used to branch off the common line near the meter, reducing the number of taps by 50 percent. Trenching costs and maintenance costs are also reduced as only one line is installed for two homes.

Common water service lines can serve a number of homes in cluster or townhouse developments. A branch larger than the typical 3/4-inch service line may be required if more units are to be served. Cost benefits of multiple service lines are directly proportional to the number of units each line serves.

Water Supply

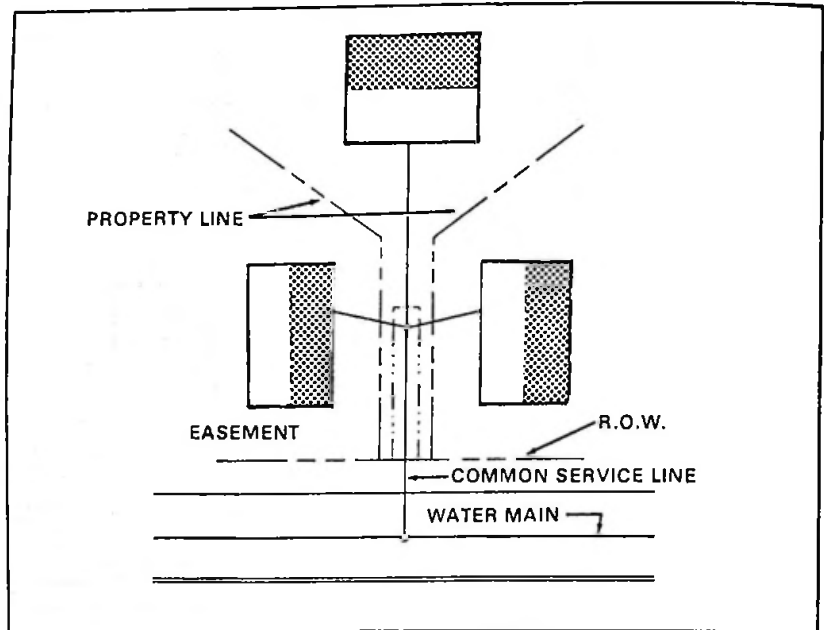

Multiple connections to a single water service line

Sizing

Many communities' standards require a six-inch, eight-inch, or even 10-inch minimum diameter for water mains, and often result in an oversized system. Residential water supply

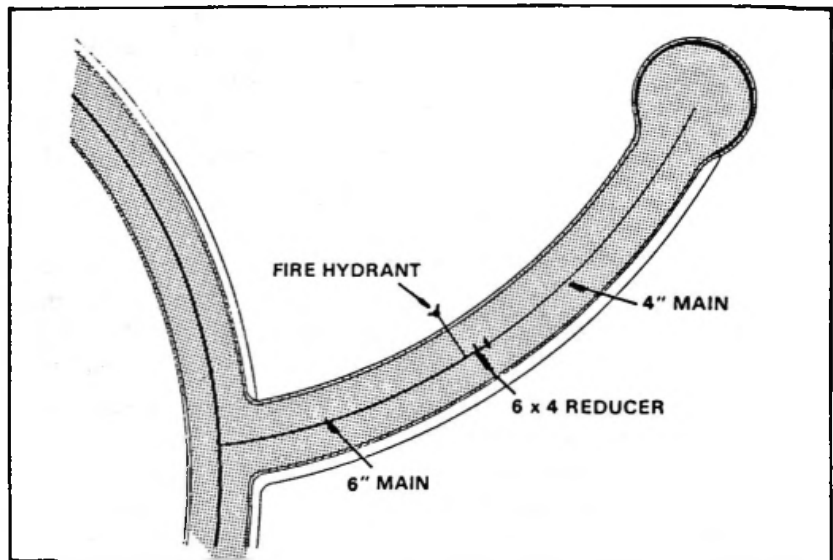

Reduced-size water main

and fire flow requirements should determine the size of water distribution piping. These requirements can often be met on short runs with two- to four-inch water lines. A larger main is generally nearby if it is necessary to install a hydrant for fire protection. Cost savings are estimated at \$4.50 per foot for a three-inch line compared to a six-inch line.

In any event, sizing should be based on anticipated demand. Small, affordable homes do not create the demand of larger homes.

Suggested Ordinance Language

Water Supply Capacity

- (a) *The water supply system shall be adequate to handle the necessary flow based on complete development.*
- (b) *Demand rates for all uses shall be considered in computing the total system demand. Where fire protection is provided, the system shall be capable of providing the required fire demand plus the required domestic demand.*
- (c) *Average daily residential demand can be computed in accordance with the housing unit type and size data shown in the following table,*
- (d) *Fire protection shall be furnished for any development connected to the municipal water supply system, and minimum fire flows shall be based on recommendations by the American Insurance Association and the National Board of Fire Underwriters.*

Source: *The Subdivision and Site Plan Handbook*, Listokin and Walker, Rutgers, The State University of New Jersey, 1989.

Water Supply

Suggested Ordinance Language

Water Demand Type and Size of Housing Unit

<i>Demand Housing Type & Size</i>	<i>Number of Residents</i>	<i>Water (gpd)*</i>
<i>Single-family detached</i>		
<i>2 Bedroom</i>	<i>2.13</i>	<i>215</i>
<i>3 Bedroom</i>	<i>3.21</i>	<i>320</i>
<i>4 Bedroom</i>	<i>3.93</i>	<i>395</i>
<i>5 Bedroom</i>	<i>4.73</i>	<i>475</i>
<i>Garden apartment</i>		
<i>1 Bedroom</i>	<i>1.57</i>	<i>120</i>
<i>2 Bedroom</i>	<i>2.33</i>	<i>175</i>
<i>3 Bedroom</i>	<i>3.56</i>	<i>270</i>
<i>Single-family attached/rowhouse</i>		
<i>1 Bedroom</i>	<i>1.69</i>	<i>125</i>
<i>2 Bedroom</i>	<i>2.02</i>	<i>150</i>
<i>3 Bedroom</i>	<i>2.83</i>	<i>210</i>
<i>4 Bedroom</i>	<i>3.67</i>	<i>275</i>
<i>High-rise apartment</i>		
<i>Studio</i>	<i>1.07</i>	<i>80</i>
<i>1 Bedroom</i>	<i>1.34</i>	<i>100</i>
<i>2 Bedroom</i>	<i>2.14</i>	<i>160</i>
<i>Mobile home</i>		
<i>1 Bedroom</i>	<i>1.73</i>	<i>130</i>
<i>2 Bedroom</i>	<i>2.01</i>	<i>150</i>
<i>3 Bedroom</i>	<i>3.47</i>	<i>260</i>

**** gallons per day***

Source: *The Subdivision and Site Plan Handbook*, Listokin and Walker, Rutgers, The State University of New Jersey, 1989.

Accessory Items

Cost-effective materials and construction techniques can be applied to meters, valves, hydrants, and fittings.

Fire hydrants are routinely installed at the terminal end of water lines and at low-lying points where it may be necessary to blow off the line. A blow-off mechanism can be substituted for hydrants that are not required for fire protection, saving approximately \$1,000 per hydrant. A standard two-inch blow off is usually adequate and can be installed by extending the main with a short section of two-inch tubing.

Standard blowoff - plan view

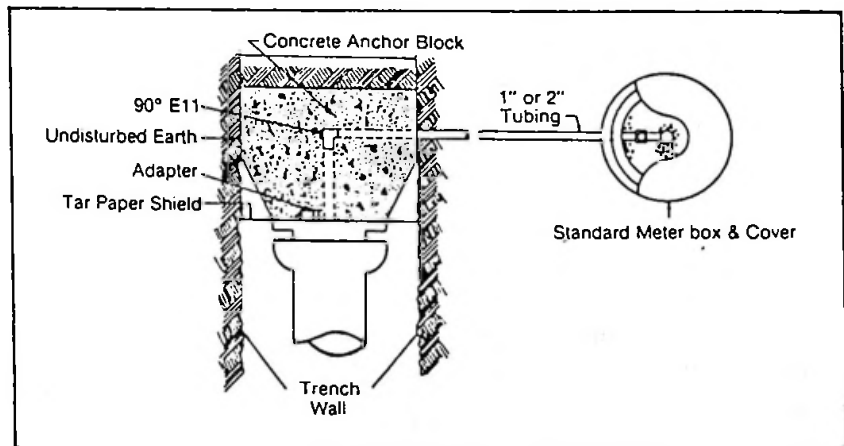

An outdoor-type water meter enclosed in a plastic meter box eliminates both the remote reader and the curbstop shut-off commonly installed with an indoor water meter and saves approximately \$60. As a safeguard against freezing in colder climates, the top of the meter is covered and placed below local frost depth.

Water Supply

Exterior water meter

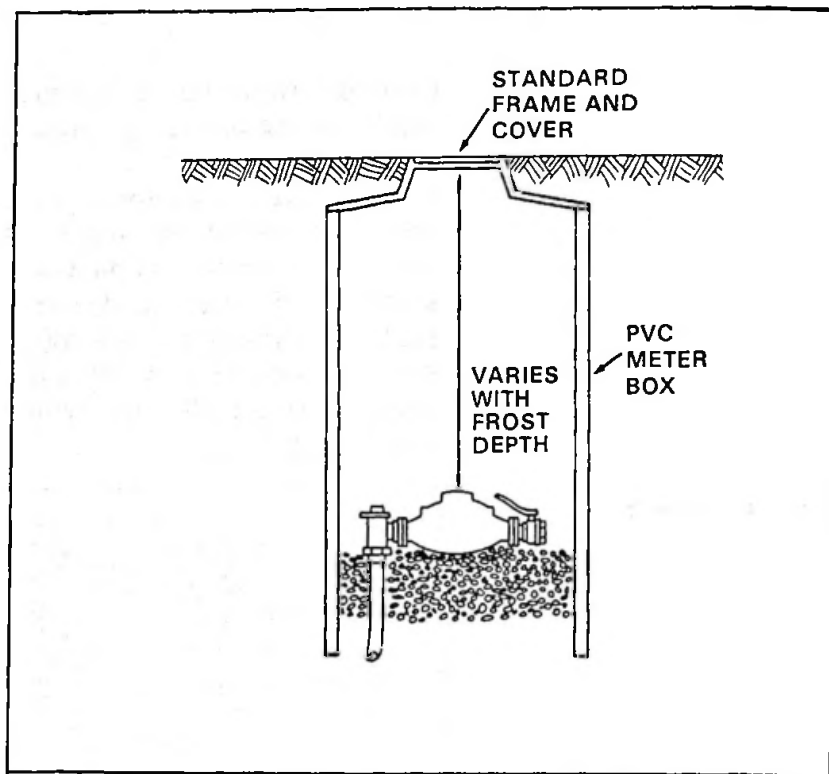

Multiple meters can be housed in a single box, an especially efficient arrangement when multiple connections are made to a single tap.

UTILITIES AND UTILITY EASEMENTS**Introduction**

One of the most costly local residential land development regulations requires placement of all utilities in public rights-of-way. A viable, less costly alternative is installation of utilities outside rights-of-way in easements.

Following are guidelines for utilities and utility easements:

- place utilities in easements instead of rights-of-way where appropriate
- use plastic piping in underground gas systems
- install direct-burial phone, cable TV, and electric lines
- use common trenching for multiple utility installations

Easements

Installation of utilities in easements is an acceptable procedure in many areas of the country. An easement often allows placement of a utility line in the shortest available path, decreasing the overall length of the line and reducing costs. Homeowners maintain and use easement areas, saving the locality money and adding land for residents' enjoyment. Legal rights to the easement land are assigned to the community, utility companies, and homeowners.

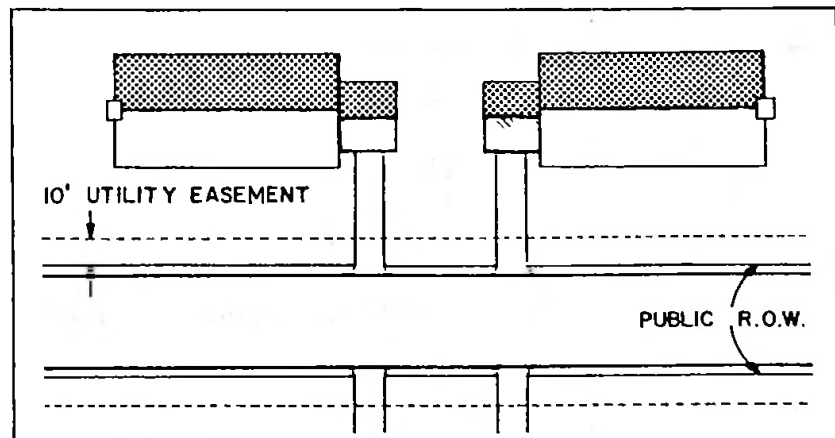

Typical utility easement

Materials

Several nontraditional materials appropriate for use in sanitary sewers, stormwater systems, and water service systems are discussed in earlier sections. Gas, electric, and cable TV can also use more effective, less costly materials.

Plastic piping, usually polyvinyl chloride (PVC) or polyethylene (PE), is used in underground gas piping systems, reducing costs and increasing ease of installation and corrosion resistance.

Direct-burial cable can be used for cable TV, telephone, and electric lines, eliminating the need for a covering or conduit to serve as a protective sleeve. The National Electric Code (NEC) permits direct-burial cable when a minimum soil cover or equivalent protection is provided.

Direct burial cable

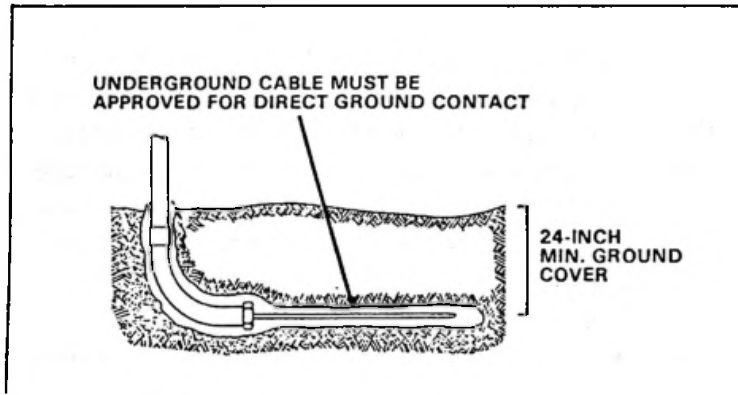

Installation

Common trenching of different combinations of utilities is becoming more acceptable. Common trenching of sanitary sewer and water lines is permitted by the major U.S. model building code organizations--ICBO, BOCA, SBCCI, and CABO. Approximately \$5 per foot can be saved in installation costs of main lines, with a smaller savings of \$2 per foot on service laterals. The water line is generally placed at least 12 inches above the sewer line, with a minimum horizontal separation of 18 inches. However, due to improved reliability in materials and construction

techniques, local codes are beginning to recognize that minimum separation distances are unnecessary.

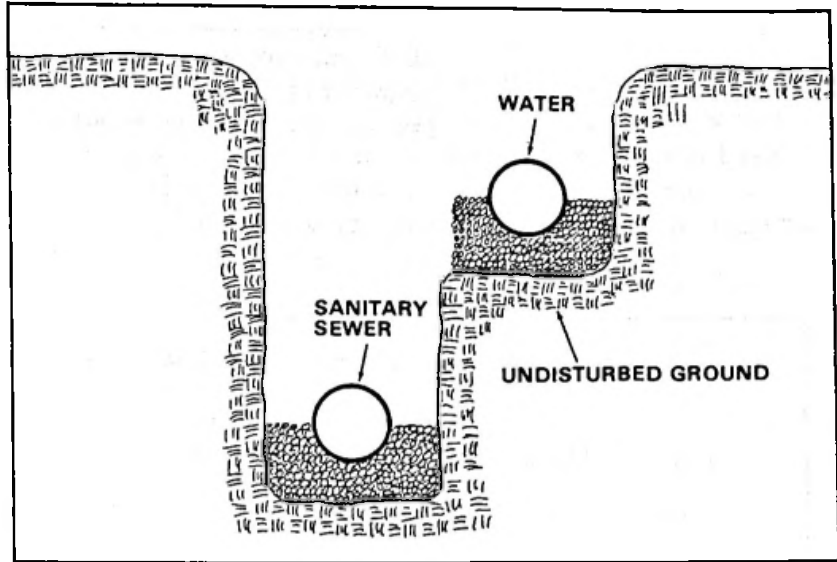

Common water/sewer trench

Common trenching is used successfully with electric, telephone, cable TV, and gas lines. The installation cost is reduced substantially if three or four utility companies share trenching expenses.

Joint CATV, telephone, electric gas trench

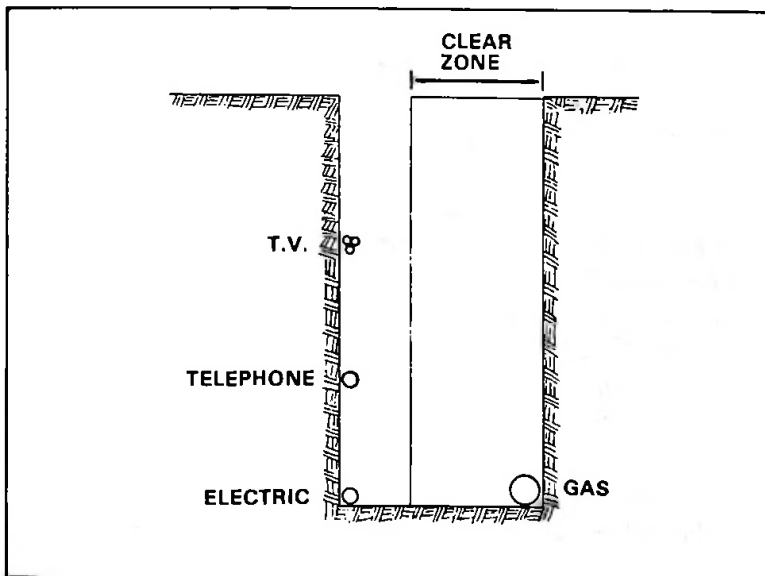

Utilities and Utility Easements

The city of Tacoma, Washington, estimates that common trenching in residential areas reduces costs an average of \$0.97 per foot where electric, telephone, and cable TV are installed in the same trench. Seattle, Washington, reports savings of 40 percent to 60 percent.

DESIGN

Introduction

Throughout the years, the average single-family home has experienced "design creep"--that is, building lots and homes have become larger; features that were once optional have become standard; and certain "niceties" have become "necessities." The following table shows how design creep has affected homes in Contra Costa County, California.

Year	Lot Size (sq. ft.)	House Size (sq. ft.)	Garage	Dish- washer	Range	Cabinets (lin. ft.)	Baths	Fireplace
1940s	2,500	900	0-1 car	No	No	6	1	No
1950s	5,000	1,000	1 car	No	No	8	1	No
1960s	6,000	1,100	2 car	Opt	Opt	10	1 1/2	Opt
1970s	6,000	1,500	2 car	Std	Opt	12	2	1
1980s	7,000	1,800	2+ car	Std	Std	14	2 1/2	1-2
1990s	7,000+	2,800+	3 car	Std	Std	16	3	2

Source: Steven Benson, Prime Properties, El Sobrante, CA.

The above table shows how buyers' expectations have helped increase housing costs. On the other hand, it also shows that, not too many years ago, homes were smaller with fewer expensive design features. To serve the enormous market of first-time homebuyers in most communities, homes must be smaller, be built on smaller lots, and have fewer amenities.

Good design and affordable housing are not incompatible. They do, however, call for greater sensitivity to the siting of the house on its lot relative to other units, increased attention to exterior appearance and detailing of the units, and a well-considered interior layout. Each of these factors can enhance rather than detract from neighborhood aesthetics and property values. In short, good design need not compromise housing affordability if builders are encouraged to follow some simple guidelines.

Certainly, the qualities that distinguish good design from poor design are somewhat subjective and vary from buyer to buyer,

builder to builder, architect to architect, and even from one region to another. But design elements that provide a sense of comfort and reflect good taste in the choice of materials, colors, space layouts, and equipment are likely to satisfy new homebuyers, existing residents, and local officials.

Unit Orientation

A primary concern in the development of small-lot affordable homes is the potential lack of privacy that can result from increased density. But homes on small lots can be sited to ensure privacy while maximizing views to the outside. The zero-lot-line (ZLL) approach, in particular, creates a single, usable yard area rather than two unusable side yards. Walls located along lot lines are windowless to provide a sense of privacy for the abutting neighbors' yards. Further, garages located at either the front or rear of the house--not at the side--can help define private spaces. The "Z" lot variation of the ZLL approach provides yet another option by angling frontages and exposing more of the home to the street.

Single-story homes can preserve privacy by eliminating views into neighboring yards. Second-level windows in two-story homes should be oriented away from nearby yards and toward natural or common areas.

Unit orientation is also a factor where passive solar design is a consideration. Any dwelling regardless of cost can take advantage of solar gain by maximizing its south-facing glass exposure and minimizing its north- and west-facing glazing.

Passive solar shading

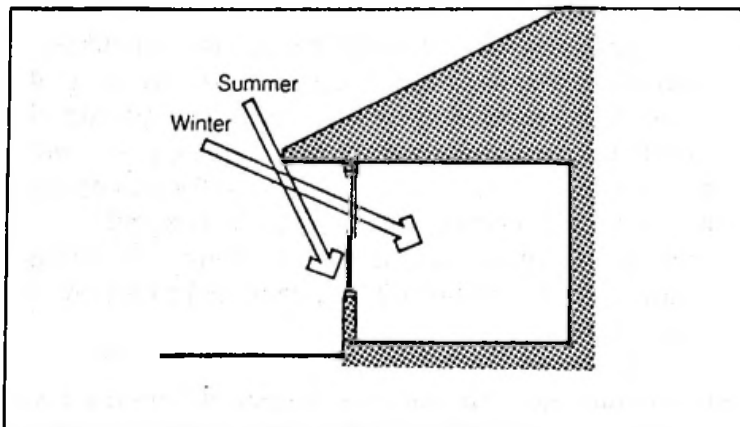

Major living spaces--living room, dining room, family room--should be oriented to the south so that rooms used during the day receive the sun's benefits. These same spaces, however, will require some type of summertime shading--roof overhangs, second-story balconies, awnings, or deciduous trees to limit heat build-up associated with summer exposures.

Exterior Appearances

Simplicity and restraint in exterior appearances tend to be more acceptable for smaller homes than visually confusing design details that "clutter" a streetscape. Guidelines for style vary with local preferences and markets, although some important principles apply regardless of location. An especially important consideration in higher-density development is unit identity as denoted by the unit entry. The primary entry must be easily distinguished from full-height windows and sliding doors on the front of the house. A transition space to the front entry that uses a pathway, change in level, or landscaping can help provide a sense of arrival as well as permit occupants to individualize their own home.

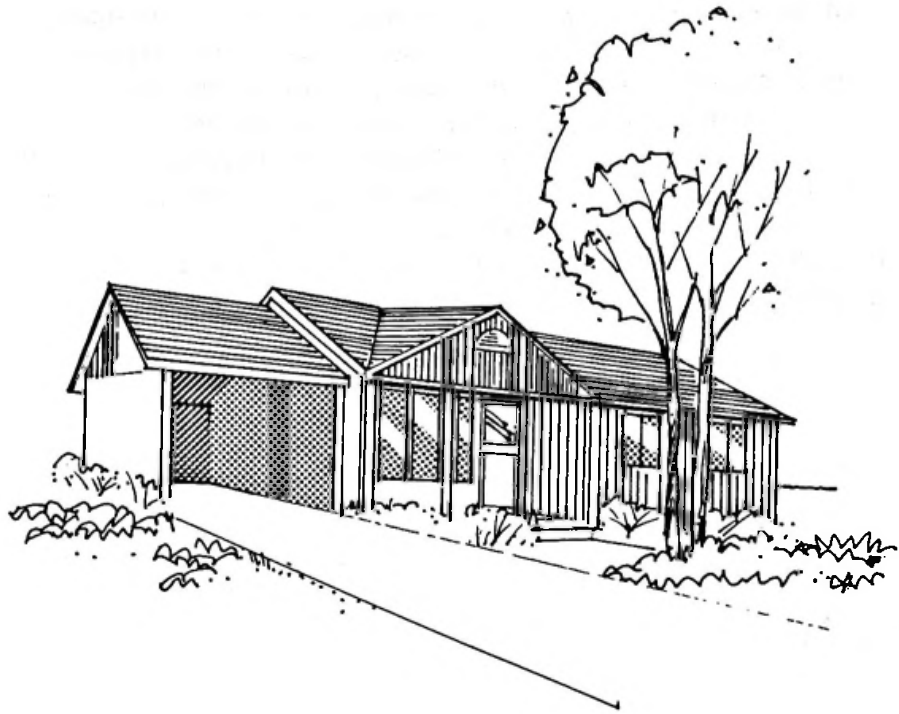

Varied facade treatment is a desirable feature in terms of color, rooflines, and building materials as long as all features are coordinated to present a unified neighborhood image. Horizontal and vertical elements must be well proportioned to provide for visual appeal and design continuity. Wall and window "bump-outs" and entry setbacks can add visual interest (as well as cost). For the roof, a strong fascia on overhangs can add depth and style. A cascade of similarly sloped roofs can be attractive and relieve the monotony of an identical roofline. Appropriate massing of units can give a neighborhood overall character.

In higher-density development, the garage often dominates the streetscape when placed at the front of the lot. Reorienting the garage so that its side faces the street can help integrate it visually into the overall unit. Similarly, placing the garage at the rear of the lot enables homes to reclaim the neighborhood street as an extension of yard areas.

Overall neighborhood appearance is a marketing consideration in higher-density development where community open space is touted as an important amenity. Landscaping detail at community and neighborhood entry points helps a new development take on an "established" look. Sidewalks or other walkways should link clusters of homes to common open spaces and minimize street crossings to ensure safe passage for children and cyclists. Lighting provides a sense of security and can highlight community features.

Unit Size

Total dwelling unit floor area is not normally a health and safety issue. Instead, unit size should be a function of need and marketability and should not be codified. On the other hand, reasonable minimum habitable room sizes have been included in the major model codes.

CABO One and Two Family Dwelling Code

Room Sizes: Every dwelling unit shall have at least one habitable room which shall have not less than 150 square feet of floor area. Other habitable rooms shall have an area of not less than 70 square feet. Every kitchen shall have not less than 50 square feet of floor area. Habitable rooms, except kitchens, shall be not less than 7 feet in any horizontal dimension.

Source: *CABO One and Two Family Dwelling Code*, Section R-204, 1989.

Interior Layout

Simply scaling down an existing unit plan to meet the cost constraints of affordable housing typically yields a house that looks and is perceived as small and confining. Smaller housing demands a design approach that allocates the larger percentage of space to the major living areas. Some designers now rely on the "great room" approach to accommodate entertaining, family relaxation, dining, and cooking. Activity areas in the great room are often defined by food preparation islands or breakfast bars, changes in floor level or floor covering material, or the placement of furniture.

Great Room floor plan

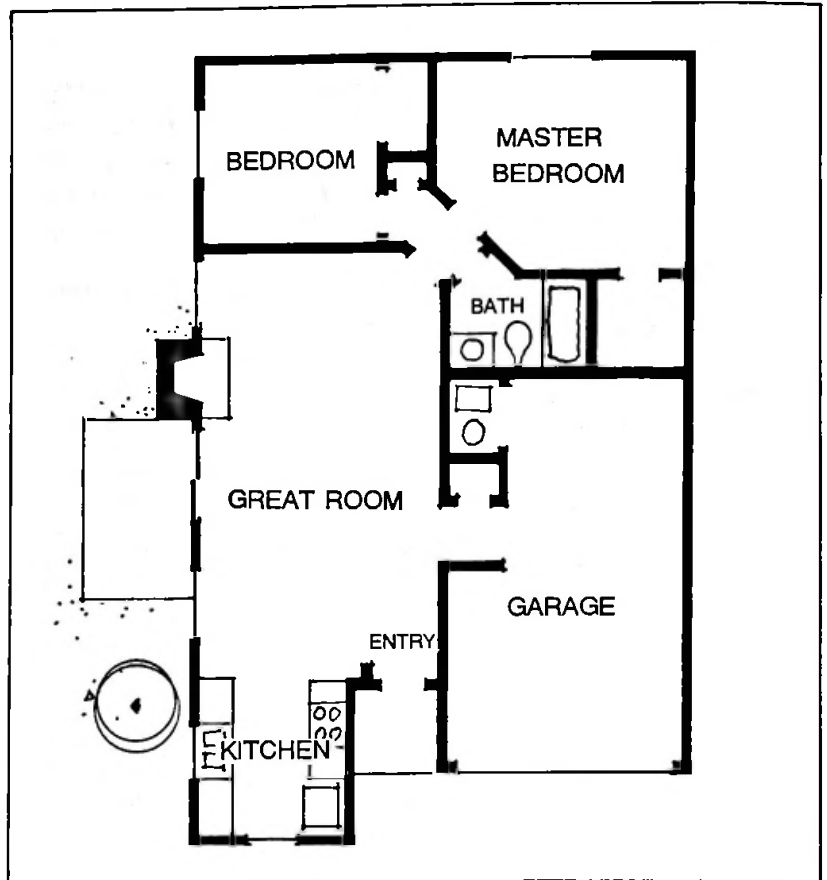

Today's smaller homes can be made to look more spacious by relying on multiuse spaces, vaulted ceilings, clerestory windows, views to the outdoors, and loft spaces. Outdoor areas such as decks, patios, porches, and garden seats visually extend the interior spaces while bringing the outdoors inside. Multiple-use spaces can help eliminate space devoted to circulation except where absolutely necessary.

In the sleeping area, excessive hallways can consume space that is better allocated to bedrooms or closets. Even modestly sized bedrooms can appear larger by designing in large windows that provide light and ventilation.

Designing for Economy

Within the framework of marketable affordable design, modular dimensioning can ensure that costs are lowered without sacrificing market appeal. Since most building materials--including trim, lumber, sheathing, and some sidings--are produced in two-foot increments, their most efficient use is realized when overall house dimensions are laid out on a two-foot grid.

Modular Dimensioning grids

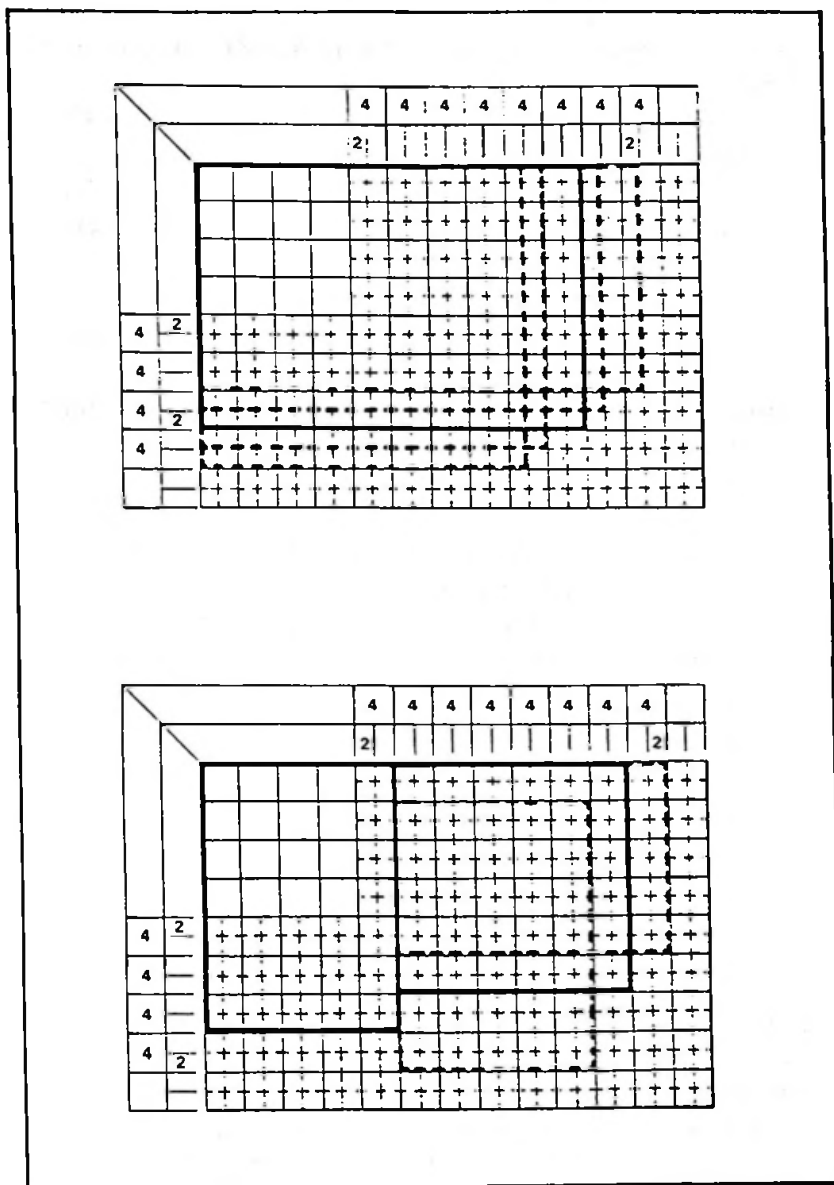

House shape and configuration affect total cost for any given amount of floor space. For example, an H-shaped plan has 46 more linear feet of wall, eight more corners, four more roofing areas, two more gable ends, and four more roof valleys than a rectangular plan.

The most cost-effective plan encloses the desired floor area with the least amount of exterior wall. The ratio of floor to wall should be as high as possible within design constraints. For example, a 28-foot by 40-foot plan yields 1,120 square feet of floor area and 136 linear feet of wall for a floor/wall ratio of 8.24/1. A 24-foot by 46-foot plan yields 1,104 square feet of floor area and 140 linear feet of wall for a ratio of 7.89/1. The 28-foot by 40-foot plan is more efficient as it takes fewer linear feet of wall to enclose more square feet of living space. The high floor-to-wall ratio approach can also apply to interior partitions.

It is obvious that the first step toward cost-effective construction is efficient design. Many costly details can be addressed in the design process. Therefore, the importance of merging good design for marketability with efficient design for construction cannot be overemphasized.

CONSTRUCTION AND BUILDING CODES

Introduction

This chapter deals primarily with the dwelling unit and the numerous systems that constitute the final product. It is written for those who are already familiar with construction terminology and typical ways of building homes. Many of the methods discussed are already acceptable under most local codes, although other methods are not presently acceptable under some local regulations. If the methods are not acceptable, it will be worthwhile to work toward cost-saving changes. Success of an affordable housing program depends on builders, government officials, and concerned citizens taking necessary steps to encourage cost-saving construction techniques.

When compared to other affordability issues, excessive building code restrictions may appear relatively unimportant. In the hierarchy of the various costs that contribute to excessive sales prices, building codes are, indeed, usually not the primary contributor. Restrictive zoning, outmoded land development standards, excessive government processing time, inadequate infrastructure, impact fees and exactions, the availability and cost of financing, no-growth attitudes, and other issues often overshadow excessive construction regulations. On the other hand, building codes in many communities contribute their fair share to the housing affordability problem.

Although some code provisions may be considered excessive and unnecessary, many builders have not kept pace with construction technology and cost-saving techniques that are already allowable under most building codes. Therefore, to blame building codes for all excessive construction costs is unfair and misleading. Builders need to understand and apply lower-cost options available under present codes. They need to educate subcontractors on the advantages of new systems or designs based on efficient construction practices and to develop detailed construction drawings that map the

mechanical runs, outlet placements, frame openings, and plumbing roughs.

Builders should also be aware that local codes are often open for favorable interpretation and for revision based on well-planned, thoughtful arguments that are supported by adequate documentation. If timely code changes appear unlikely, it may be best to work for variances. When a variance has proven itself, its permanent incorporation into the code becomes more probable. Builders can avoid disputes by becoming familiar with the local code and asking for interpretations early in the design process. They should also take an active stance during code hearings and regulatory decision-making processes.

All major model codes have an alternate materials and systems section that is intended to provide a mechanism for appropriate and innovative use of materials other than those described in the body of the code. This section of the code requires that adequate evidence or proof be submitted to substantiate any claims regarding the proposed alternative. It should be used liberally whenever engineering or other evidence indicates that code provisions result in excessive costs.

CABO One and Two Family Dwelling Code Language

Alternate Materials and Systems. The provisions of this code are not intended to limit the appropriate use of materials, appliances, equipment or methods of design or construction not specifically prescribed by this code, provided the building official determines that the proposed alternate materials, appliances, equipment or methods of design or construction are at least equivalent of that prescribed in this code in suitability, quality, strength, effectiveness, fire resistance, durability, dimensional stability, safety and sanitation.

The building official may require that evidence or proof be submitted to substantiate any claims that may be made regarding the proposed alternate.

Source: CABO One and Two Family Dwelling Code, Section R-108.1, 1989.

Footings and Foundations

Because the footing and foundation transfer the weight of the dwelling to the soil, prudent engineering principles and

calculations are necessary. But, given that prescriptive code requirements usually codify the worst case situation, costs for all but worst case soil conditions are excessive. A cost-effective foundation system design depends on such factors as climatic conditions, soil-bearing capacity, topography, and calculated building loads.

Footing Widths

Generally, concrete footing widths are determined by total design loads measured in pounds per linear foot (plf) of footing and by soil-bearing capacity measured in pounds per square foot (psf). Ideally, the building's total live and dead loads at the bottom of the footing should be balanced against the allowable bearing capacity of the soil. If soil-bearing tests are made under performance-based codes, footing widths can often be reduced substantially.

The design load of the structure depends on the weight of the structure itself as well as on the weight of the people and furnishings that will occupy the structure. For wood-framed, single-family homes, total design loads do not normally exceed 1,500 pounds per linear foot for one-story homes or 2,000 pounds per linear foot for two-story units.

Soil-bearing characteristics vary but are often locally known with sufficient reliability to serve as a basis for footing design. Where locally accepted values are suspected to be low for a particular site, it may be advantageous to conduct soil-bearing tests to determine if footing sizes can be reduced. Soils with an allowable bearing capacity of less than 1,500 psf are rare.

CABO One and Two Family Dwelling Code Language

Dead Load: In estimating the dead load for the purposes of structural design, the actual weights of materials and construction shall be used with consideration for the dead load of fixed service equipment.

Source: *CABO One and Two Family Dwelling Code*, Section R-201.3, 1989.

CABO One and Two Family Dwelling Code Language

Minimum Uniformly Distributed Live Loads
(psf)

<u>Use</u>	<u>Live Load</u>
Balconies (exterior)	60
Decks	40
Fire escapes	40
Garages (passenger car only)	50
Attics (no storage with roof slope not steeper than 3 in 12)	10
Attics (limited attic storage)	20
Dwelling units (except sleeping rooms)	40
Sleeping rooms	30
Stairs	40

Source: CABO One and Two Family Dwelling Code, Section R-201.4, 1989.

The following tables show how the variables of design load and soil-bearing capacity affect necessary footing widths:

Column Footing Size
for Typical Single-Family Dwelling Loads
(in inches)

<u>Total Design Load (lbs)</u>	-----Allowable Soil Bearing Capacity (psf)-----			
	<u>1,500</u>	<u>2,000</u>	<u>2,500</u>	<u>3,000</u>
5,000	22x22	19x19	17x17	16x16
10,000	31x31	27x27	24x24	22x22
15,000		33x33	30x30	27x27
20,000			34x34	31x31

Source: *Reducing Home Building Costs with OVE Design and Construction*, Guideline 5, U.S. Department of Housing and Urban Development, November 1977.

By using an engineered approach, footing sizes can often be reduced significantly as shown by the tables. If the thickness of a solid concrete wall provides sufficient bearing, a separate footing may not be required at all. In practice, however,

**Footings Widths
for Typical Single-Family Dwelling Design Loads
(in inches)**

Design Load (plf)	-----Allowable Soil Bearing Capacity (psf)-----			
	<u>1,500</u>	<u>2,000</u>	<u>2,500</u>	<u>3,000</u>
1,000	8	6	4.8	4
1,500	12	9	7.2	6
2,000	16	12	9.6	8
2,500	20	15	12.0	10

Source: *Reducing Home Building Costs with OVE Design and Construction*, Guideline 5, U.S. Department of Housing and Urban Development, November 1977.

codes are often based on a single set of conditions. For example, the *CABO One and Two Family Dwelling Code* bases exterior wall footing widths on an allowable soil pressure of 2,000 psf with a minimum width of 12 inches and calls for a minimum column footing size of 24 inches x 24 inches x 8 inches. Under CABO, soil with less than 2,000 psf allowable pressure requires footings designed by an engineer⁶.

Footings Reinforcement

Reinforcement of concrete footings is required by some local codes or is routinely installed as "local practice," although footing reinforcement is seldom necessary for footings placed on undisturbed or well-compacted soil. However, footings in expansive soils should always be designed by a qualified engineer and will most likely require reinforcing. Otherwise, elimination of footing reinforcing rods is often a legitimate method of reducing costs.

Footings Depth

Typically, footings extend to or below the frost line to avoid the heaving action of frozen soil. Other local factors such as ground-water tables and certain soil types may also affect footing depth requirements. Footings should normally extend

⁶ *One and Two Family Dwelling Code*, Section R-303, Council of American Building Officials, 1989.

Construction and Building Codes

down to original undisturbed soil or, in some cases, to well-compacted fill as determined by a qualified engineer.

A footing used extensively in Scandinavian countries for a number of years is the **frost-protected shallow foundation**. This system uses foam plastic insulation to prevent the soil under the footing from freezing, thereby reducing the requirement for extending the footing below normal frost lines. The system is being investigated in the United States and, if tests prove positive, it may become available for widespread use. If so, the system would result in substantial foundation cost reduction in colder climates.⁷

Basement Foundation Walls

The controlling factors in basement foundation wall design are the lateral pressures of backfill against the wall and the foundation wall's capacity to carry building design loads. Basement walls are normally supported laterally against soil pressure by the basement floor at the bottom and by the first-story floor at the top. Basement wall constructions of concrete and concrete block have evolved over a long history of use in residential construction. Where these constructions have proven satisfactory under normal conditions, engineering design is not required. However, it may be worthwhile to have a structural engineer analyze local "standard" basement wall construction practices to determine if they are excessive.

⁷ For more information on the system, contact the Society of the Plastics Industry, 1275 K Street, NW, Washington, DC 20005.

CABO One and Two Family Dwelling Code Language

Design required: Foundation walls subject to more pressure than would be exerted by backfill having an equivalent fluid weight of 30 pounds per cubic foot shall be designed in accordance with accepted engineering practices.

Source: CABO One and Two Family Dwelling Code, Section R-304.4, 1989.

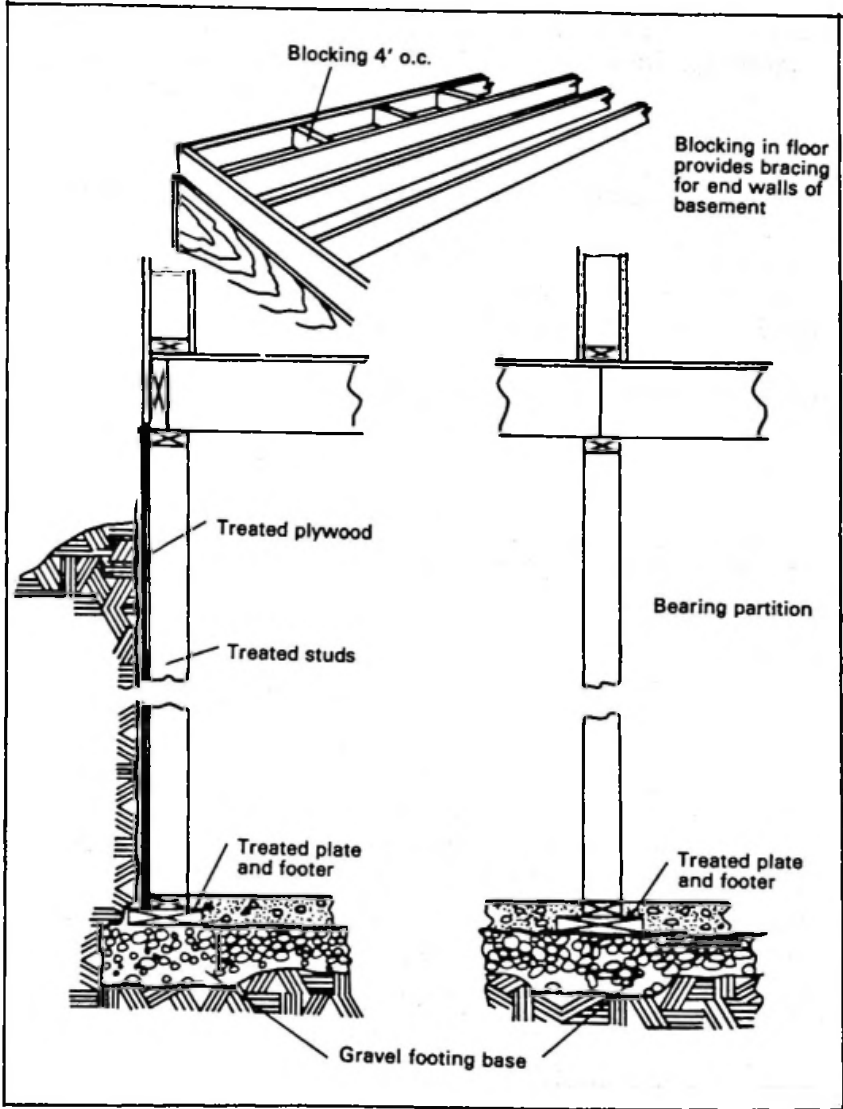

Wood foundation

Construction and Building Codes

An acceptable alternative to concrete and concrete block foundation walls that is popular in some parts of the country is the **pressure-treated wood foundation**. Marketed under the name "Permanent Wood Foundation,"⁸ it is built on the principles of exterior wall construction using lumber and plywood containing a high level of pressure treatment. Wood foundation footings are normally gravel with a treated footing plate. The foundation wall is built with treated wood studs and treated plywood sheathing. Stud size and spacing are functions of the amount of backfill. Advantages include rapid erection, easily insulatable wall cavities, and, usually, lower cost.

⁸ *Design, Fabrication, and Installation of the Permanent Wood Foundation*, National Forest Products Association.

Suggested Code Language

Wood Foundation Walls: *Wood foundation walls shall be constructed in accordance with the provisions of this section, with footings as shown in the National Forest Products Association Technical Report No. 7, The Permanent Wood Foundation System, Basic Requirements, 1987, and with lumber and plywood pressure preservatively treated in accordance with the American Wood Preservers Bureau grade **AWPB FDN**, and shall be identified as to conformance with such standard by an approved agency.*

All load-bearing lumber and plywood shall conform to applicable standards or grading rules and be identified by a grade mark or certificate or inspection issued by an approved lumber or plywood grading or inspection bureau or agency.

When height of fill is more than 12 inches above the interior grade or crawl space or floor of a basement, the plywood sheathing shall be designed to resist inward soil pressures occurring at the bottom of the wall in accordance with the following table.

Wood foundation walls, for most soils, shall be designed assuming a lateral soil pressure of 30 pounds per cubic foot equivalent fluid weight. For soils high in clay or fine silt and of low permeability, or for poorly drained soils, a higher pressure shall be assumed in accordance with NFOPA Technical Report No. 7.

Wood foundation walls shall not be backfilled until the basement floor and first floor have been constructed or the walls have been sufficiently braced. For crawl space construction, backfill or bracing shall be installed on the interior of the walls prior to placing backfill on the exterior.

Wood foundation basements shall be drained and dampproofed in accordance with NFOPA Technical Report No. 7.

Sources: *CABO One and Two Family Dwelling Code*, Section R-304.5, 1989, and National Forest Products Association Technical Report No. 7, 1987.

Slab-on-grade foundations

Under suitable site conditions, the least expensive foundation system is usually the concrete slab-on-grade. Ground-supported slabs are not subject to the span limitations of other floor systems and are especially popular in warmer climates. Even in cold climates, slabs are often less costly than basements or crawl spaces. Sloping sites and other conditions that require substantial amounts of fill present the major limitation for slabs.

In warmer climates where the frost line is near the surface and perimeter heat loss is of minor concern, **monolithic slab**

foundations that combine the footing, foundation, and slab floor into one unit are especially cost-effective. The basic monolithic slab foundation consists of a four-inch-thick concrete slab with a thickened edge. The basic simplicity of this approach minimizes construction time, scheduling delays, and other cost-related factors.

In other than the warmest climates, the floor slab should be separated from the foundation with perimeter edge insulation to prevent excessive heat loss at the slab edge. The independent footing must extend down to the frost line. On sites with high soil-bearing capacity, a narrow trench filled with concrete will often be sufficient for the loads imposed by a dwelling unit.

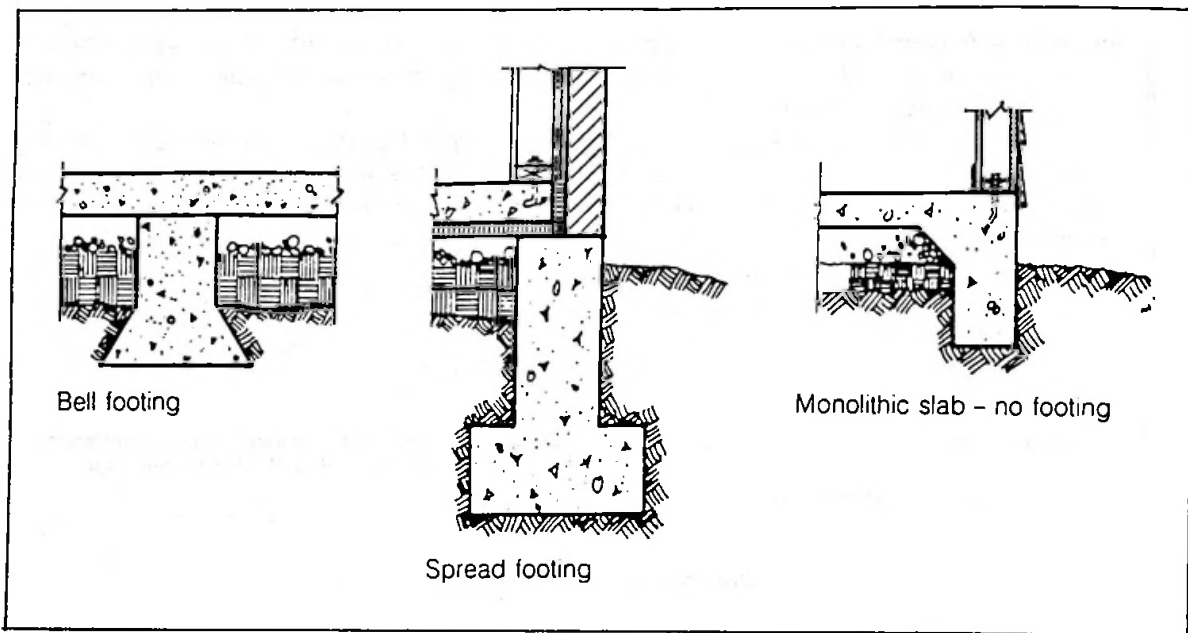

Slab footings

The concrete floor slab is usually 3 1/2 inches thick, placed on a layer of crushed stone or gravel covered with a 6-mil polyethylene moisture barrier. Under normal conditions with a stable base, concrete slab floors do not require reinforcement of any type. Welded wire mesh is not recognized as a primary reinforcement and provides no significant function in slab-on-grade floors. It does not reinforce against shrinkage crack formation, impact forces, abrasion, water migration, or shattering. When installed correctly (in the upper third of the slab, covered by at least one inch of concrete), welded wire mesh does limit the width

of cracks. But, in fact, mesh is seldom installed correctly. Further, because properly placed control joints localize cracks and carpet or resilient flooring covers slab cracks, it is clear that the use of welded wire mesh is of dubious value.

Under normal conditions with a stable, well-compacted base, the thickness of concrete slab floors might be reduced to 2 1/2 inches. Slabs are continuously supported by the earth and base and support only live loads. When interior load-bearing walls are built, a slab thickened at the loading points will suffice. A four-bag, 2,000-pound concrete mix is structurally adequate for this application and results in less shrinkage.

In expansive and other nonstable soils, concrete slabs must be engineered according to soil expansion coefficients and bearing capacities and most often must be designed by qualified soils engineers. For affordable housing, problem soils should be avoided if at all possible as engineered slabs are normally costly to build.

Suggested Code Language

Structural slabs-on-grade and mat-type footings for dwellings located on expansive soils shall be designed and installed in accordance with the Post-Tensioning Institute's Post-Tensioned Slabs-on-Ground or the Wire Reinforcement Institute's Design of Slabs-on-Ground Foundations, or in accordance with other approved methods.

Source: CABO One and Two Family Dwelling Code, Section R-303, 1989.

Crawl space foundations

On sloping sites, crawl space foundations are often the least costly alternative. They may be constructed of conventional masonry or concrete or of pressure treated wood similar to that used in basement construction. Where expansive soil is a problem, pier and beam crawl space foundations with nonbearing curtain walls have been successful in some areas of the country.

Wood Floor Construction

Most wood-frame floors are built with nominal two-inch-thick dimensional lumber joists, although manufactured floor "trusses" have begun to enjoy a degree of success in some types of housing in some parts of the nation. The design of floor trusses varies according to the manufacturer. The basic advantage of floor trusses over conventional joists is their longer clear spans between supports. They are usually more costly but their increased design flexibility is attractive to many builders. In addition, some manufactured floor trusses are more dimensionally stable because they do not shrink over time, perhaps resulting in fewer floor squeaks.

Floor design is based on a number of factors, such as

- design load
- lumber species, size, and grade
- clear span between supports
- floor sheathing materials and thickness
- fastening techniques

Sill Plate

First-story wood-frame floors are anchored to the foundation to resist wind forces acting on the structure. Traditionally, a 2 x 6 sill plate is attached to the foundation wall with anchor bolts, or powder-actuated fasteners and joists are toe-nailed into the sill plate. If a sill plate is used, a 2 x 4 member is adequate on both solid concrete or hollow core masonry foundation walls. Sill plates may be attached to the foundation with metal anchor straps that are embedded in the foundation. Anchor straps are bent around the sill plate and nailed, thereby eliminating hole drilling for anchor bolts. the location of anchor straps is less exacting and does not interfere with joist placement as anchor bolts often do.

If the top of the foundation is sufficiently level and accurate, sill plates may be eliminated. Joist anchorage to the foundation can be provided by heavy steel straps set in concrete or mortar, spaced to coincide with joist spacing. A sill plate is not required on pressure-treated wood foundations as floor joists bear directly on the foundation wall top plate.

CABO One and Two Family Dwelling Code Language

Bearing: The ends of each joist, beam or girder shall have not less than 1-1/2 inches of bearing on wood or metal and not less than 3 inches on masonry except where supported by the use of approved joist hangers or on a 1x4 ribbon strip and nailed to the adjacent stud.

Floor systems having joists framing from opposite sides over a bearing support shall be tied together by lapping joists a minimum of 3 inches or with a wood or metal splice, or by continuity of floor sheathing overlapping the ends of joists at least 3 inches, or by other approved methods.

Joists framing into the side of a wood girder shall be supported by approved framing anchors or on ledger strips not less than nominal 2 inches by 2 inches.

Source: CABO One and Two Family Dwelling Code, Section R-602.3, 1989.

Floor Center Support Beam

Typically, a conventional dimensional lumber wood-frame first-story floor is supported by an intermediate beam located about midway between the front and rear foundation walls. In multistory construction, the beam also supports the upper floors, most often with load-bearing walls extending down to the beam. In most cases, the optimum location for the center bearing beam is along the centerline of the structure. This allows for evenly spaced floor joists on both sides of the beam and maximizes the allowable joist spans.

In most cases, **built-up wood beams** are more cost-effective than **steel I-beams**. In addition, wood beams do not require a separate wood sill as do steel beams. Joists may be nailed directly to the wood beam. Dry lumber should always be used for built-up wood beams to reduce potential shrinkage problems. Where greater spans are required between beam support columns or piers, steel I-beams are often preferred.

Using the **full-span capacity of lumber joists** can often save between 6 percent and 8 percent of joist-framing costs. If allowable spans for joists exceed the spans shown on the floor plan by one foot or more, important savings may be realized by changing joist grade, spacing, or size. **Double floor joists** under nonbearing interior partitions are unnecessary as the weight of the wall does not warrant extra support. If floor sheathing is 5/8-inch thick or greater, nonbearing partitions require no extra support. Load-bearing interior walls

Construction and Building Codes

normally run perpendicular to joists and do not require additional support. Load-bearing walls that run parallel to floor joists require a supporting beam system.

Mid-span **bridging or blocking** between floor joists has been proven ineffective in almost all cases. Extensive tests conducted by the NAHB National Research Center in the early 1960s proved that mid-span bridging adds nothing to the structural integrity of most floor systems. Major model codes require mid-span bridging only in floors with joists exceeding a depth-to-thickness ratio of six to one based on nominal dimensions. This means that joists up to and including 2 x 12s do not require bridging. In addition to its lack of effectiveness, bridging is often the source of eventual floor squeaking. On floor joists exceeding the six to one ratio, lateral support can be provided by a 1 x 3 nailed to the bottom of the joists.

CABO One and Two Family Dwelling Code Language

Lateral support and bridging: Joists having a depth-to-thickness ratio of 6 to 1 or less based on nominal dimensions shall not require additional lateral support. Joists having a depth-to-thickness ratio exceeding 6 to 1 shall be supported laterally by solid blocking, diagonal bridging (wood or metal) or a 1- by 3-inch bridging nailed to the bottom of the joist at intervals not exceeding 10 feet.

Source: *CABO One and Two Family Dwelling Code*, Section R-602.4, 1989.

Costs of **stairwell framing** can be reduced in the design stage by locating stairwell openings parallel to floor joists. Double joists (trimmers) on each side of the opening are not necessary where the header supported by the trimmers is located within four feet of the end of the joist spans. In addition, a single member header is generally adequate for openings up to and including four feet in width.

The major function of the **band joist** (sometimes called the rim or header joist) is to keep the floor joists vertical. If floor joists and wall studs are aligned, the band joist is not bearing any loads--therefore, a nominal one-inch-thick board or plywood band is adequate. In some cases, the band may be eliminated altogether. When wall and floor framing members are aligned and structural sheathing is used on the exterior

walls, the sheathing can be extended over the ends of the floor joists where the band would normally be. In this case, joists must be temporarily braced until wall sheathing is installed.

The allowable span of floor joists may be increased by maintaining continuity over the center bearing beam--that is, where the joist is continuous rather than lapped over the beam. If two joists of unequal length are spliced so that the splice occurs at a point about two feet off center, an increase in stiffness of up to 40 percent is possible. This **off-center spliced-joist⁹** technique can result in reduced lumber size, increased spacing, or both. In addition, subfloor layout is greatly simplified. However, the added cost of end trimming and splicing the joists must be considered.

CABO One and Two Family Dwelling Code Language

Off-Center Spliced Floor Joists: Floor joists that are spliced at a point other than over a structural bearing element shall be designed in accordance with NAHB Research Report: Design Tables—Fabrication Guide, Off-Center Spliced Floor Joists or by approved engineering practice.

Source: *CABO One and Two Family Dwelling Code*, Section R-602.2.1, 1989.

⁹ *Off-Center-Spliced Floor Joists (143-5)*, National Association of Home Builders.

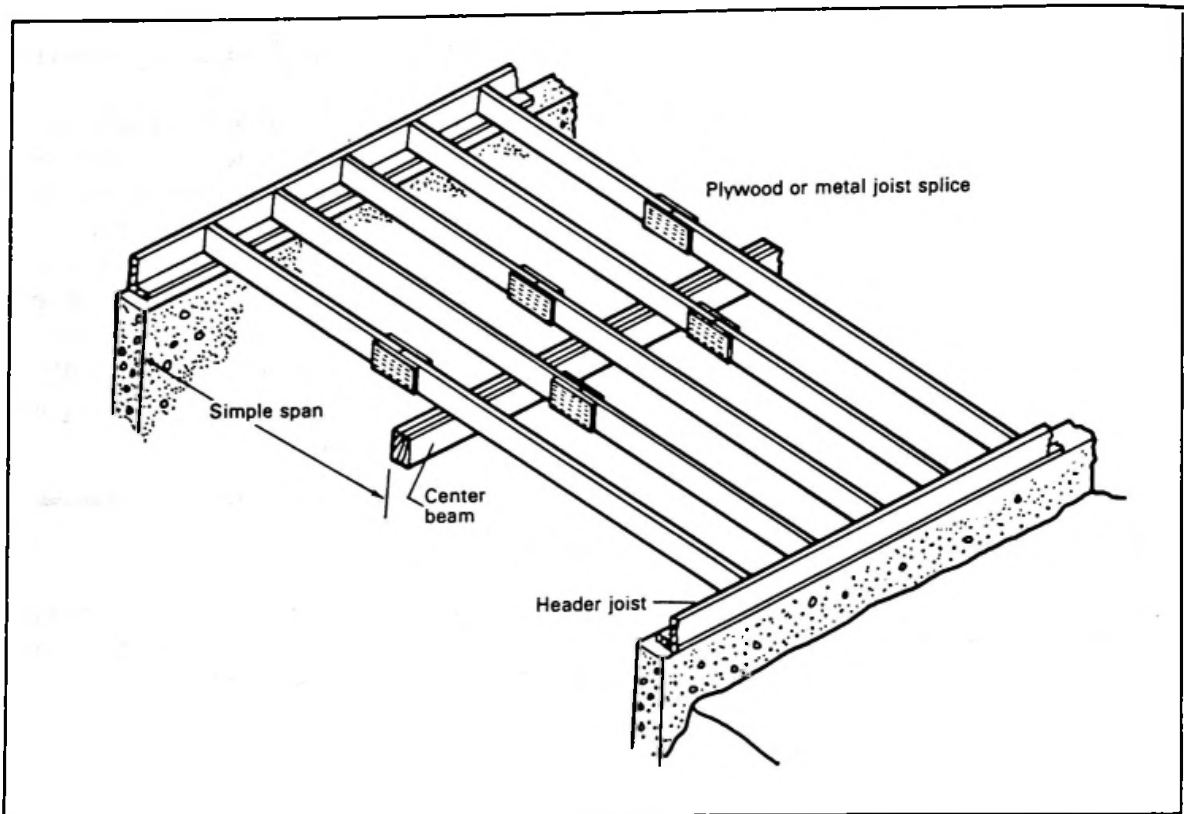

Off-center spliced joist system

Floor trusses are becoming more popular as alternatives to conventional wood-frame floors. They have the advantage of greater spans between supports, thereby creating increased design flexibility. Open web joists have the additional advantage of providing plumbing, wiring, and HVAC chases without drilling or cutting. One major disadvantage of floor trusses is their increased height, which adds cost to sheathing, siding, stairs, etc.

Floor sheathing adds stiffness to the floor and, depending on thickness and fastening techniques, can result in reducing the size and/or increasing the spacing of framing members. When properly glued and nailed to the joists, the subfloor and joist act as a composite T-beam and as such span a greater distance than if the subfloor were fastened with nails only. Glue nailing is also effective in reducing floor squeaks. A

single-layer tongue-and-groove system is usually less costly than a separate subfloor and underlayment system. In recent years, composite floor sheathing materials such as oriented strand board (OSB) have been developed and proven to be structurally adequate and, in many cases, less costly than plywood.

Walls and Partitions

The key to economic wall and partition construction lies in eliminating unnecessary materials and labor. Cost savings will be greatest when the overall out-to-out dimensions of the house and the location of windows and doors coincide with the normal lengths and widths of materials used in the walls. Coordination of dimensions provides maximum use of available materials, reducing scrap, waste, and labor time for cutting to fit. For wood-frame construction, most building material is provided in increments of two or four feet. Therefore, a wall length that is divisible by four feet would make maximum use of lumber and plywood. Concrete masonry units (block) are used in some areas of the country, especially for exterior wall construction. Because 16-inch-wide block is normally used, out-to-out dimensions of exterior walls and the dimensions to openings should be designed in 16-inch increments. An important responsibility of the contractor is to educate work crews in cost-saving approaches based on planning for the dimensional requirements of the proposed structure.

Wood-frame tilt-up wall construction continues to be the preferred method among most builders. Whether built on- or off- site, wall sections should reflect the dimension of their component materials.

Building 7 1/2-foot-high walls instead of eight-foot-high walls saves approximately one course of siding or two courses of brick, 6 percent of wall insulation, 3 percent of painting labor and material, one tread and riser in a flight of stairs, and nine to 12 inches of stair landing space. A lower ceiling height increases the structural capacity of studs that also act as columns. In smaller houses, the exterior sense of scale may also be improved with lower wall heights. If major interior

Construction and Building Codes

spaces are to have vaulted or cathedral ceilings, the 7 1/2 foot wall will not be noticeable.

Under most conditions, the major model codes allow studs placed 24 inches on center in load-bearing walls instead of the conventional 16 inches for one-story construction and for the second story of two-story construction. Use of 24-inch stud spacing saves nearly one-third of all wall studs. When used in combination with roof and floor framing spaced 24 inches on center, the result is **in-line framing**--a highly efficient use of framing materials. In-line framing means that roof loads bear directly on the studs, which, in turn, bear directly on the floor joists. Eccentric "zig-zag" load transfer through the framing members is eliminated.

CABO One and Two Family Dwelling Code Language

Maximum Stud Spacing (Inches)

<i>Stud Size</i>	<i>Supporting Roof and Ceiling Only</i>	<i>Supporting One Floor Roof & Ceiling</i>	<i>Supporting Two Floors Roof & Ceiling</i>	<i>Supporting One Floor Only</i>
2x4	24*	16	—	24*
3x4	24*	24	16	24
2x5	24	24	—	24
2x6	24	24	16	24

**Shall be reduced to 16 inches if Utility grade studs are used.*

Source: CABO One and Two Family Dwelling Code, Table No. R-402.3d, 1989.

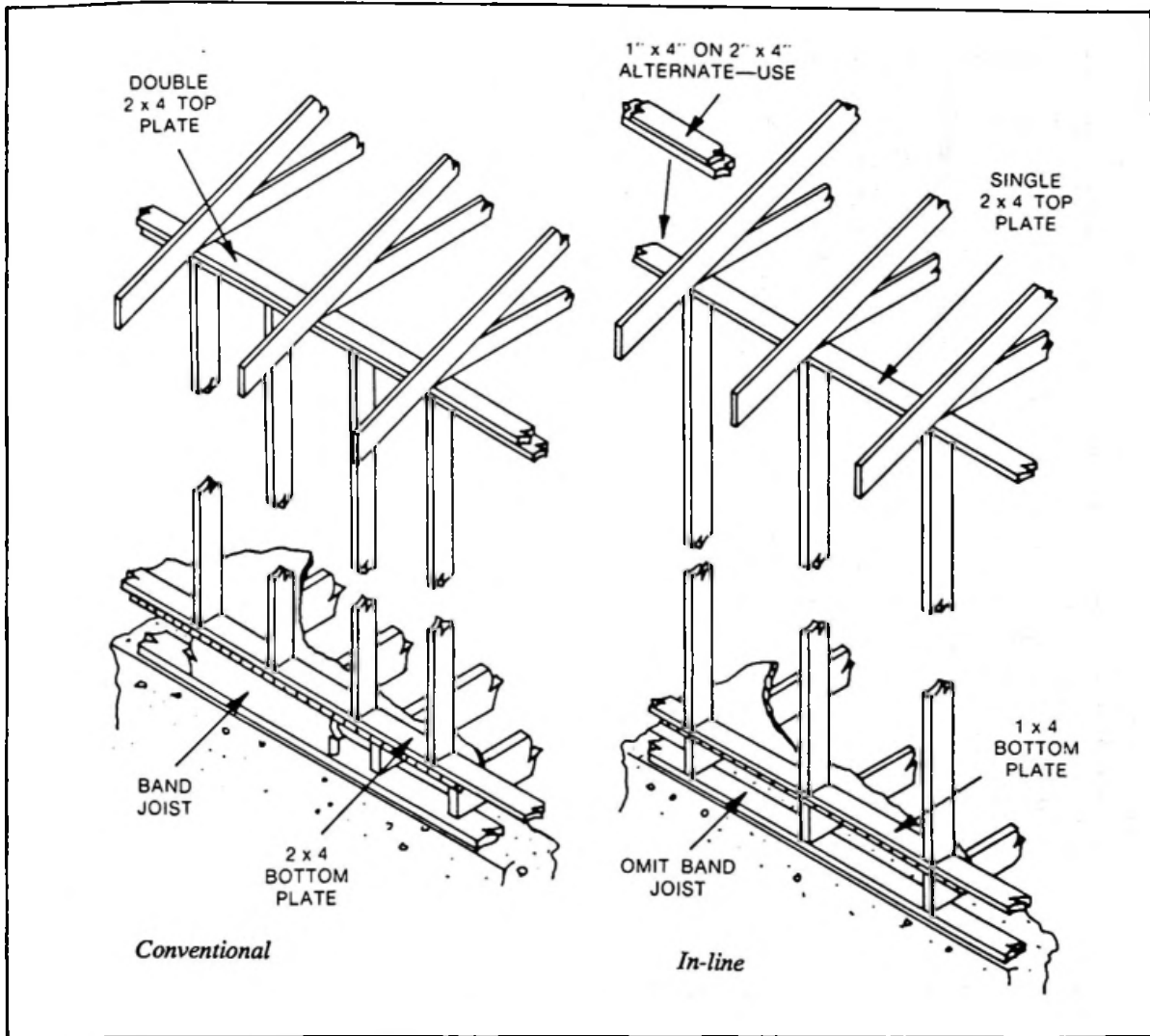
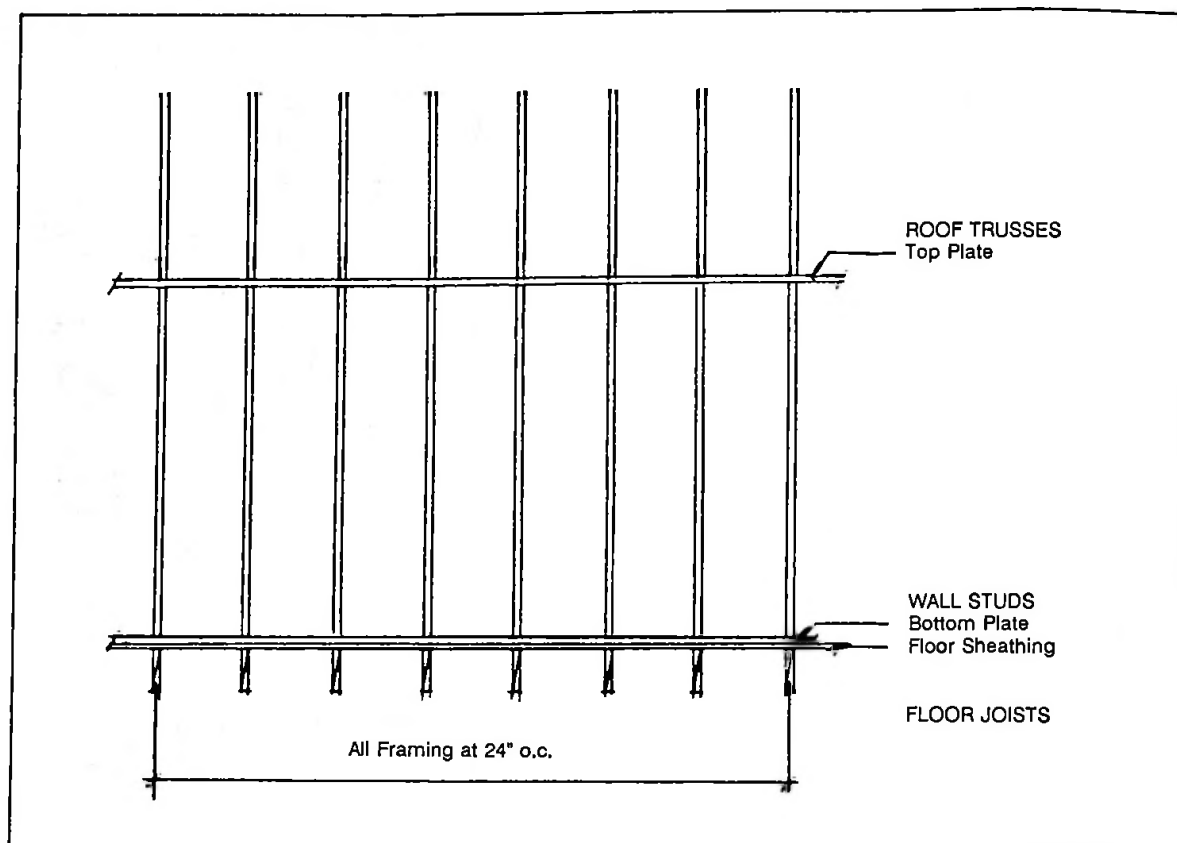

Diagram of In-line wall framing

In nonbearing interior partitions, 2 x 3 studs spaced 24 inches on center with 1 x 3 top and bottom plates provide adequate strength for noncritical applications. The thinner walls add an inch to the dimensions of each room. The *CABO One and Two Family Dwelling Code* recognizes single top plates for interior nonbearing partitions (Section R-402.4).



Section of In-line wall framing

Light-gauge steel studs have been used in commercial and multifamily construction for years but have made little impact on single-family construction. Many drywall contractors handle installation of steel studs. It may be worthwhile to investigate occasionally the cost differences between wood and steel studs, especially for nonbearing walls. Drywall and wood trim must be installed with screws.

Single top plates are possible in bearing walls when studs and trusses are in line on 24-inch centers because roof loads bear directly on the studs. The major reason a second top plate is normally used is to help transfer roof loads to the nearest stud. With the in-line framing approach, the second plate becomes superfluous. Special connectors that splice joints in the top plate or tie corners together are not necessary because the roof or second-floor system serves this function. If studs are spaced 24 inches on center, ends of top plate material should fall over a stud. Otherwise, minor trimming of plate material may be necessary for plate joints to coincide with studs.

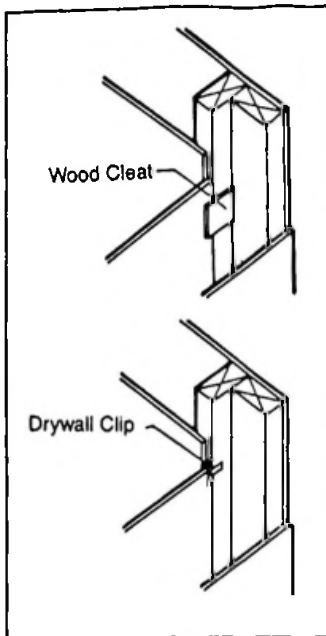

2-Stud corner

Partition post elimination

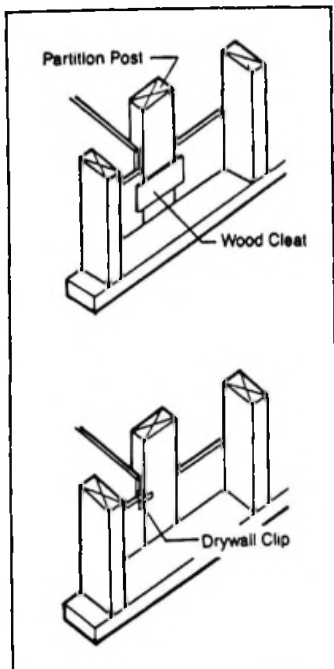

The *CABO One and Two Family Dwelling Code* recognizes the adequacy of a single top plate in bearing walls **only** if it is adequately tied at joints, corners, and intersecting walls by at least the equivalent of 3-inch by 6-inch by 0.036-inch-thick galvanized steel that is nailed to each wall or segment of wall by three 8d nails or equivalent, provided the rafters or joists are centered over the studs with a tolerance of no more than one inch (Section R-402.3). Other major model codes have similar requirements.

In most cases, the wall **bottom plate** serves no structural function. Theoretically, it could be eliminated; practically, however, it lays out and aligns studs and keeps them in vertical alignment until sheathing and drywall are installed. Because of this, the bottom plate can be a 1 x 4 in four-inch walls or a 1 x 6 in six-inch walls, fastened with 8d nails.

Most builders use at least three studs and spacer blocking where two walls intersect. The third stud serves only to back up the interior finish and the blocking serves only to space the third stud. By using metal drywall clips or wood cleats, the third stud and blocking can be eliminated, leaving the end stud of each intersecting wall to form a **two-stud corner**. Even without the third stud, intersecting walls are the most structurally sound sections of the entire wall system. In addition, a three-stud corner prevents full insulation of the exterior wall.

Partition posts (or channels) are not required where interior partitions intersect exterior walls. Like the third stud at a corner, partition posts serve primarily to back up interior wall finish materials. In addition, they interrupt the insulation in the exterior wall, leaving "cold spots" and thermal short circuits. Ideally, the interior partition will intersect the exterior wall at a normal stud location and may be attached directly to it. If not, one mid-height block may be installed between exterior studs for attachment of the partition to the midpoint as well as to the top and bottom plates. Drywall back-up can be provided by metal clips or wood/plywood cleats and the mid-height block. This approach saves at least two studs at each wall intersection.

Construction and Building Codes

Some builders install **mid-height fire blocking**, although it is not required by any of the major model codes under most conditions. In platform framing where a one-story wall has a top plate, firestopping is provided by the plate. Full-thick batt insulation also provides a degree of fire safety inasmuch as it helps prevent vertical drafts. In balloon framing with a two-story-high wall, fire blocking is required at the ceiling and floor levels. Mid-height blocking serves no practical purpose except where structural bracing is needed. Section R-402.7 of the *CABO One and Two Family Dwelling Code* deals with firestopping requirements.

Structural headers are installed to support loads over openings in exterior and other load-bearing walls. In practice, they are often used over openings that are nonload-bearing. In nonload-bearing interior partitions and in exterior end walls with framing running front to back, structural headers are not normally necessary as all structural loads are borne by the front and rear exterior walls and by interior load-bearing walls. A single flat 2 x 4 member may be used as a header in exterior and interior nonbearing walls for openings up to eight feet wide if the vertical distance to the parallel nailing surface above is not more than 34 inches. No cripples or blocking are required above nonbearing headers. When solid or built-up wood headers are needed, the proper size header for each loading condition should be selected.

Where structural headers are necessary, consider the use of **glue-nailed plywood headers**.¹⁰ Such headers are formed by glue-nailing a plywood face onto the framing above an opening. It is important to use a suitable structural adhesive for this application and at least an A/C grade plywood with the "A" side facing outward. If 1/2-inch plywood and 1/2-inch gypsum wallboard are used, the joint between the two can be taped and spackled. A thin coat of spackling compound will cover plywood imperfections for painting. A side benefit of plywood "box-beam" headers is that they can be fully insulated.

¹⁰ *Construction Guide, Design Tables and Technical Report for Plywood Headers for Residential Construction*, National Association of Home Builders.

CABO One and Two Family Dwelling Code Language

Headers: Nailed-only plywood-box headers shall be designed in accordance with the NAHB Construction Guide, Design Tables and Technical Report for Plywood Headers for Residential Construction, or by approved engineering practice.

Load-bearing headers are not required in interior or exterior nonbearing walls. A single flat 2-inch by 4-inch member may be used as a header in exterior nonbearing walls up to 8 feet in width if the vertical distance to the parallel nailing surface above is not more than 34 inches. For such nonbearing headers, no cripples or blocking are required above the header.

Source: CABO One and Two Family Dwelling Code, Section R-402.6, 1989.

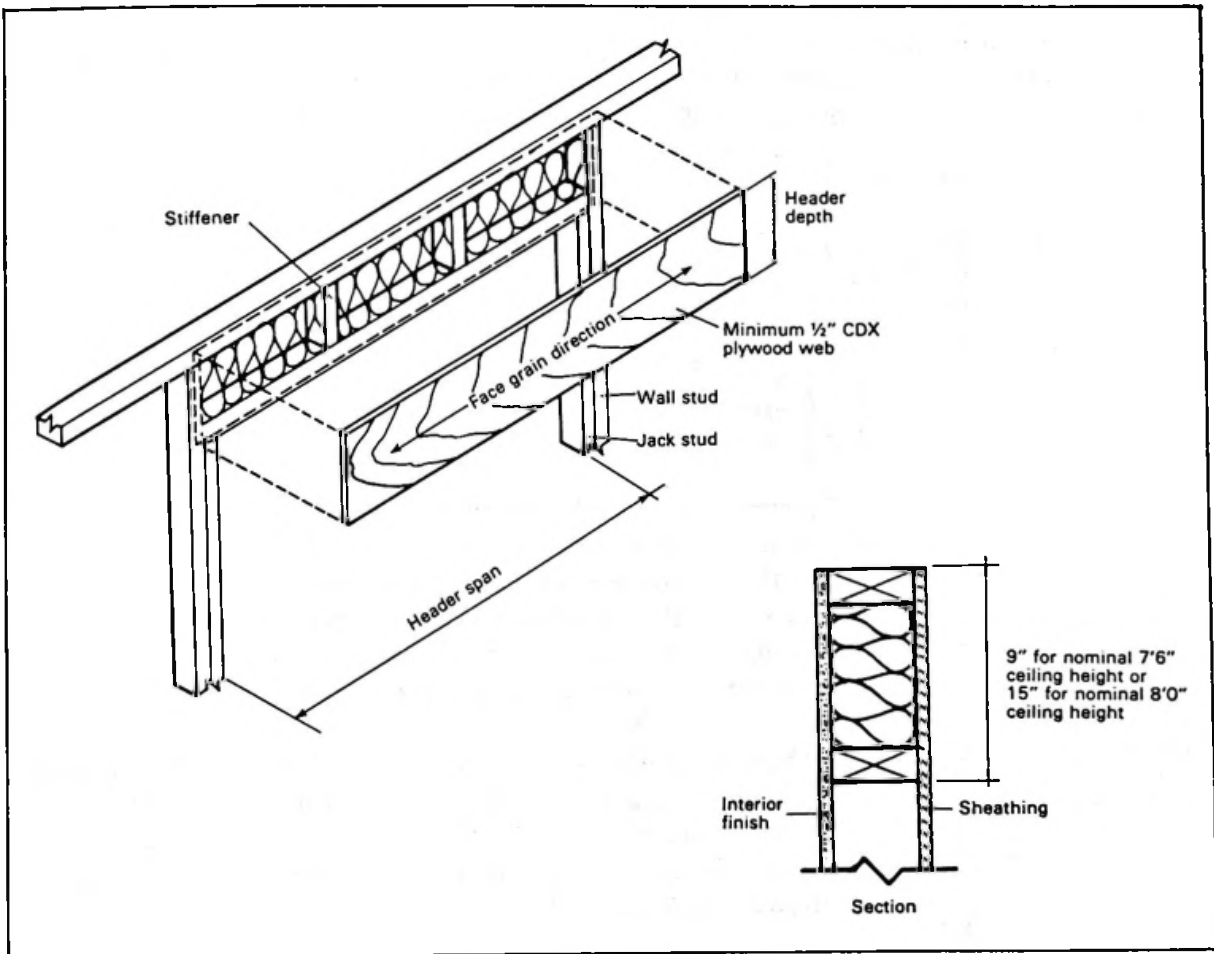

Plywood header

Consider **single-layer panel siding** that does not require the additional support of separate sheathing and may be applied directly to the studs. Such siding normally provides adequate racking resistance without additional bracing. However, sidings with open joints or that otherwise might allow wind or rain to penetrate into the exterior wall should be installed over a suitable nonvapor-blocking infiltration barrier.

Single frame openings in nonbearing partitions are adequate, regardless of opening width. Doubled studs, or "trimmers," are not necessary under normal conditions.

Single-frame openings

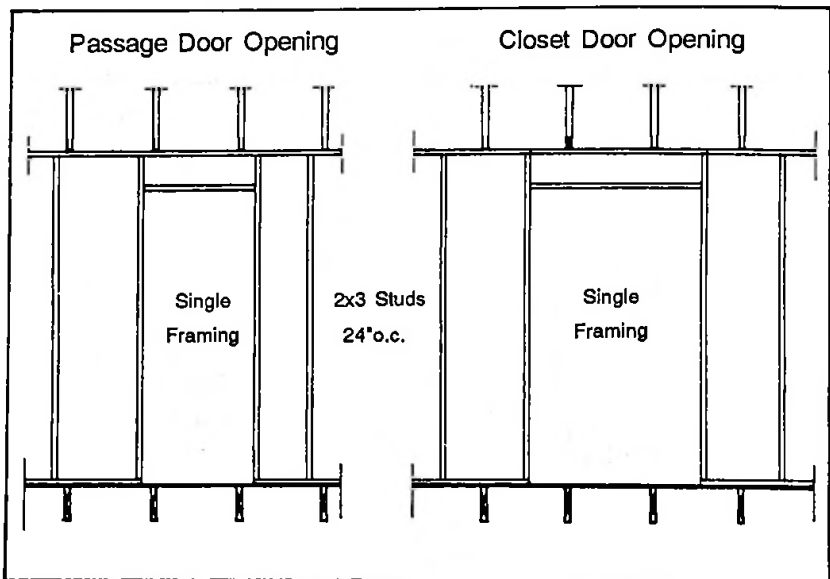

When 5/8-inch or thicker subflooring is used, nonbearing partitions that are parallel to floor framing do not require additional **floor blocking or special support**. The weight of the partition is normally much less per square foot than most furniture that will be placed in the room.

Where partitions are parallel with ceiling joists or overhead roof framing, **precut blocks** spaced 24 inches on center between the overhead framing members are adequate to secure the top plate of the partition and provide ceiling drywall back-up.

To help **prevent drywall cracking** at wall/ceiling and wall/wall intersections, do not fasten drywall within 12 inches of the joint. This arrangement allows the joint to "float" with

minor shrinking or other movement of framing members. Drywall tape and spackling will help hold the joint together.

Bulkheads over kitchen cabinets are costly and difficult to insulate properly. Consider their elimination or the use of extra-height cabinets that abut the ceiling. This is particularly appropriate where a 7 1/2-foot finished ceiling height is used. If bulk-heads are eliminated, tops of kitchen cabinets can be used for storage of seldom used kitchen items, for house plants, or for display of collectibles.

Roof Framing and Sheathing

Use of trusses has, for the most part, simplified roof framing to the degree that few innovations can further reduce costs. However, roof pitch can be calculated to maximize sheathing application and reduce scrap, waste, and installation labor. In addition, efficient treatment of overhangs can be a source of cost savings.

Roof overhangs

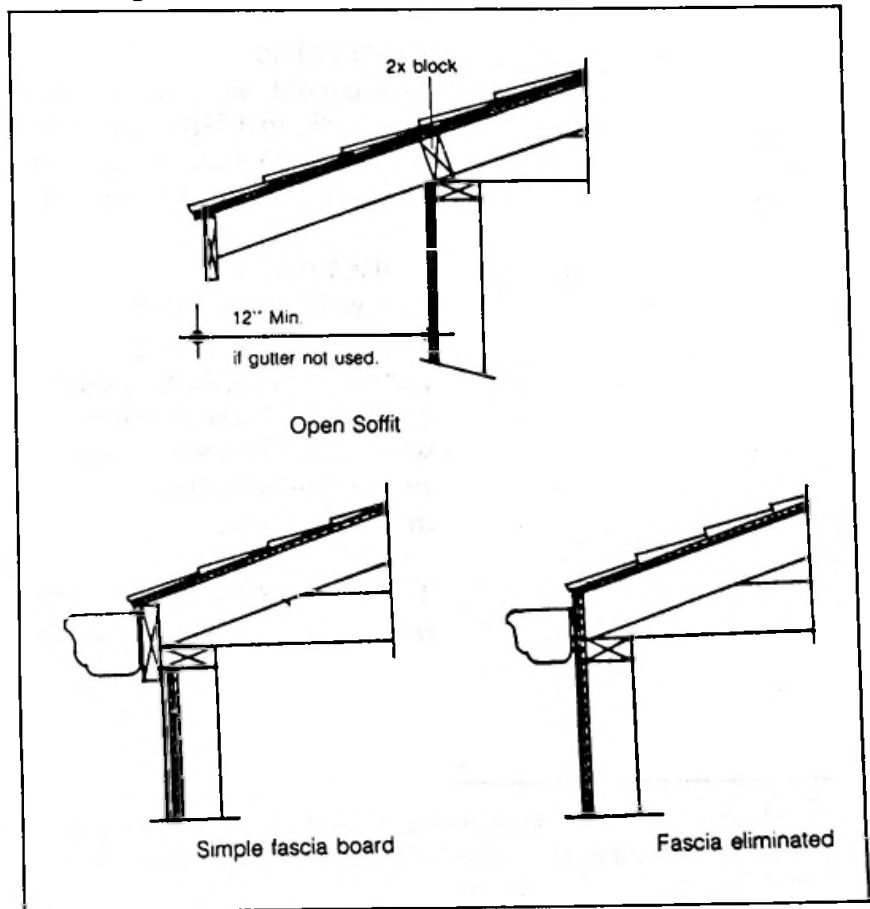

Plumbing

Today, many regions of the country are approaching a crisis in water supply capacity. Fixture manufacturers and standards writers have responded by developing and approving water-conserving fixtures. Fixtures with even lower discharge volumes such as one-gallon-per-flush toilets are being introduced or planned. The new products have created concern among plumbing and wastewater treatment professionals over the long-term effect of water-conserving fixtures on traditional drain, waste, and vent (DWV) systems designed to transport wastes from fixtures with discharge volumes more than twice those of current fixtures. Some jurisdictions such as Indianapolis have recognized the advantage of reduced size DWV lines to achieve proper transport of water-borne solids.

In the early 1960s, the National Bureau of Standards (NBS)--now the National Institute of Standards and Technology (NIST)--conducted research on residential drainage system designs under dynamic flow conditions rather than the steady flow conditions often assumed in plumbing tables.¹¹ These and additional NBS studies sponsored by the U.S. Department of Defense resulted in reduced venting requirements for DOD installations.

In the 1970s, HUD's Operation BREAKTHROUGH created renewed interest in engineered plumbing. The Stevens Institute of Technology in New Jersey, building on the NBS plumbing work, developed new information on single-stack drainage systems, water-conserving fixtures, and peak demand water use. This work culminated in a new "curve" for water supply that recognizes the reduced flow characteristics of modern fixtures.

The NAHB National Research Center, drawing upon the work conducted by NBS and the Stevens Institute, developed

¹¹ *Capacities of Stacks in Sanitary Drainage Systems for Buildings*, Monograph 31, and *Investigation of the Hydraulics of Horizontal Drains in Plumbing Systems*, Robert S. Wyley, National Institute of Standards and Technology.

Residential Plumbing Guidelines.¹² Application of the guidelines has resulted in the design and installation of safe and healthy residential plumbing systems that produce cost savings of more than \$500 over the provisions of the major model codes. Jurisdictions concerned about affordable housing should investigate this plumbing approach, which is based on actual rather than hypothetical plumbing fixture discharge rates. Many of the innovations mentioned in *Residential Plumbing Guidelines* have been incorporated into the *CABO One and Two Family Dwelling Code*.

Even though model plumbing codes are updated periodically, the code-change process is lengthy and uncertain. Therefore, none of the model codes represents state-of-the-art developments. In addition, the model plumbing codes, except the *CABO One and Two Family Dwelling Code*, cover all types of buildings and are, by their nature, overly complex for dealing with the relatively simple requirements for single-family residences. The need for standardization and simplification has become apparent.

¹² Available from National Association of Home Builders, 15th and M Sts., NW, Washington, DC 20005.

Plumbing System Design

During the design of the dwelling, costs can be reduced by **clustering plumbing**, or installing "back-to-back" plumbing. The basic principle is to arrange typical plumbing groupings such as bathrooms, kitchen, and laundry on a common wall or, in multiple-story buildings, vertically on a common stack. All fixtures discharge into a common drain and vent system and are supplied by a common hot and cold water riser, minimizing DWV and water supply labor and materials. The water heater should also be located close to the grouping. To realize up to 10 percent DWV and supply cost savings, the subcontractor must give proper cost credit for the design efficiency.

Back-to-back plumbing

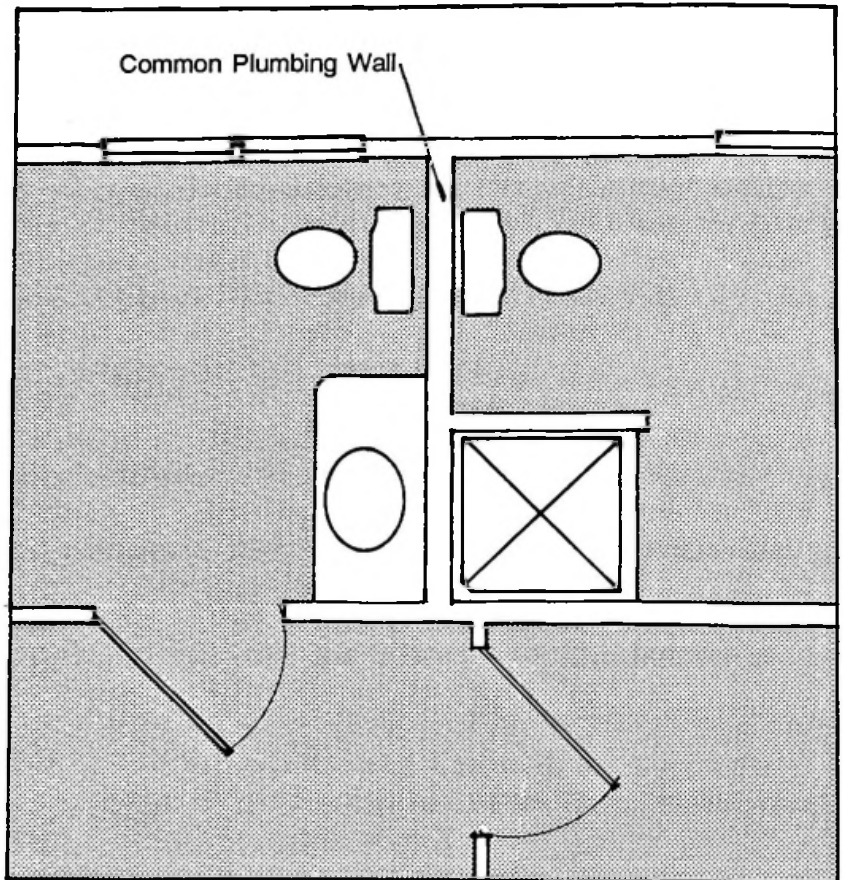

Drains and Vents

Loads on drain, waste, and vent systems are determined by **drainage fixture unit (d.f.u.)** values, a measure of the probable discharge into the drainage system by various types

of plumbing fixtures. These values are used to size DWV piping systems. The *CABO One and Two Family Dwelling Code* plumbing section has adopted new d.f.u. values that are, in almost every case, less than those specified by other major model codes. The CABO code also includes d.f.u. values for plumbing groupings that are less than the sum of individual fixture units and thereby recognizes that the probability of simultaneous use is exceedingly low. The following table presents the d.f.u. values permitted under the CABO code.

CABO One and Two Family Dwelling Code Language

***Drainage Fixture Unit (d.f.u.) Values
for Various Plumbing Fixtures***

<u>Type of Fixture or Group of Fixtures</u>	<u>Drainage Fixture Unit Value</u>
<i>Bathtub (with or without shower head and/or whirlpool attachments)</i>	1.6
<i>Clothes washer</i>	1.6
<i>Dishwasher</i>	1.6
<i>Kitchen sink</i>	1.6
<i>Lavatory</i>	0.9
<i>Laundry tub</i>	1.6
<i>Shower stall</i>	1.4
<i>Water closet (tank type or flushometer tank)</i>	3.7
<i>Full-bath group with bathtub (with or without shower head and/or whirlpool attachment on the bathtub or shower stall)</i>	5.3
<i>Half-bath group (water closet and lavatory)</i>	4.1
<i>Kitchen group (dishwasher and sink with or without garbage grinder)</i>	2.9
<i>Laundry group (clothes washer and laundry tub)</i>	2.9
<i>Multiple-bath groups</i>	
<i>1-1/2 baths</i>	6.8
<i>2 baths</i>	7.6
<i>2-1/2 baths</i>	8.5
<i>3 baths</i>	9.3
<i>3-1/2 baths</i>	10.1
<i>Additional 1/2 bath if part of group</i>	1.5

Source: *CABO One and Two Family Dwelling Code*, Section P-2205, 1989.

The 1989 version of the CABO code allows 75 foot spacing of drain cleanouts (Section P-2206.2.1) versus 50 feet in the old version. The spacing is consistent with the availability of

Construction and Building Codes

standard snake lengths. In addition, CABO allows **smaller-diameter traps and trap arms** (Section P-2206.6.7) for some fixtures and, in recognition of power-driven cleanout equipment, has reduced below-grade pipe diameter minimums from two to 1 1/2 inches. CABO also allows an **increase in maximum trap arm lengths** (Section P-2206.7), providing a degree of architectural flexibility in locating sinks under windows.

Large-diameter drain pipe is often believed to be desirable but, with the lower discharge rates of modern residential fixtures, produces particularly low flow rates that promote deposition of solids. **Smaller-diameter pipe** with higher flow rates provides improved transport characteristics. This is a classic case where bigger is not necessarily better and where traditional knowledge is not always correct.

Plumbing venting systems serve a dual purpose. They maintain atmospheric pressure within the DWV system to prevent trap seals from siphoning, aspiration, or backpressure. They also vent to the outdoors sewer gases that may otherwise accumulate within the system. Traditionally, large-diameter vents that penetrate the roof have been used. The research conducted by the National Bureau of Standards and the Stevens Institute proved that small-diameter vents are adequate in most cases. These research results have not been fully accepted by any major code-writing body, although CABO has adopted vent sizes that are smaller than those permitted by any other model codes.

The NAHB National Research Center's *Residential Plumbing Guidelines* includes the complete reduced-size venting as proved effective by NBS and the Stevens Institute. Recommended vent sizes follow:

<i>Suggested Code Language</i>		
<i>Minimum Size for Dry Vents</i>		
<u><i>Venting Application</i></u>	<u><i>Load Served (d.f.u.)</i></u>	<u><i>Vent Size (in.)</i></u>
<i>Individual Fixture Vent (single trap only)</i>	<i>3.9 or less</i>	<i>1/2</i>
	<i>4.0 or more</i>	<i>3/4</i>
<i>Common Vent Waste Stack Vent or Wet Vent Extension</i>	<i>3.9 or less</i>	<i>3/4</i>
	<i>4.0 to 6.9</i>	<i>1</i>
	<i>7.0 to 15.9</i>	<i>1-1/4</i>
<i>Soil Stack Vent</i>	<i>6.9 or less</i>	<i>1</i>
	<i>7.0 to 15.9</i>	<i>1-1/4</i>
	<i>16.0 to 30.0</i>	<i>1-1/2</i>
<i>Vent Stack</i>	<i>10.9 or less</i>	<i>1-1/4</i>
	<i>11.0 to 30.0</i>	<i>1-1/2</i>

Source: *Residential Plumbing Guidelines*, NAHB National Research Center, 1986.

In addition to the above, the *Residential Plumbing Guidelines* includes adjustments for vent lengths over 30 feet and for effluent that falls more than one story before being diverted into a horizontal drain pipe. Methods of determining branch vent sizes are also included.

The *CABO One and Two Family Dwelling Code*, 1989, Section P-2207.6, includes the following table of vent sizes:

<u>Venting Application</u>	<u>Minimum Vent Size (in.)</u>
Dry vent extension from individual fixtures, fixture groups, or waste stacks	1-1/4*
Individual soil stack vents and w.c. vents	1-1/2
Combined stack vent from two or more stacks	2

*Except water closets

Source: *CABO One and Two Family Dwelling Code* 24, Section 2207.6, 1989

As shown, the CABO code does not recognize the large vent size reductions recommended by the *Residential Plumbing Guidelines*. Unlike the other major model codes, it does, however, specify smaller than traditionally used vents.

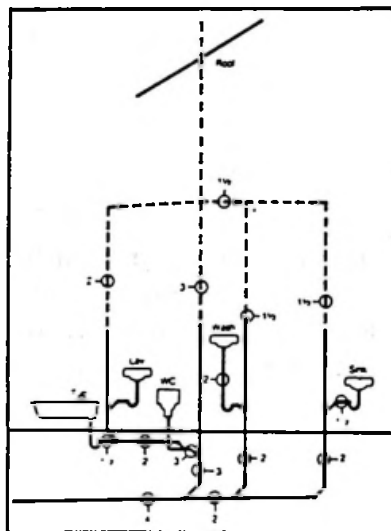

Common plumbing vent

According to Section P-2207.7.1 of the *CABO One and Two Family Dwelling Code*, "A common vent may be used for two waste fixtures connecting at different levels in the stack but within the same branch interval, provided the vertical drain is one pipe diameter larger than the upper fixture drain, but in no case smaller than the lower fixture drain. The vertical piping between fixture connections serves as a wet vent for the lower fixture."

The same code also states in Section P-2207.8, "Stack venting, with certain preconditions relating to drainage loads and ventings, fitting types and sizes, and placement of connections shall be permitted as a system that allows fixtures and fixture groups to be independently connected to a soil or waste stack without individual fixture venting."

Stack vent

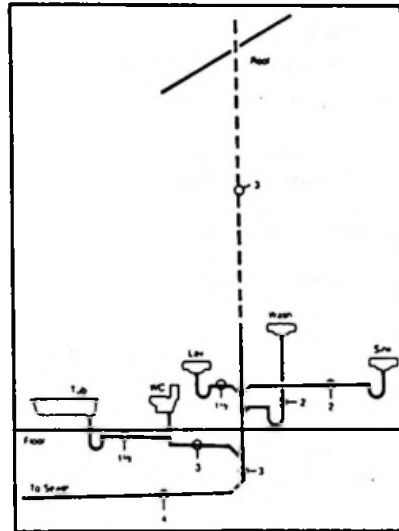

The significance of common and stack venting is that, when compared to conventional plumbing practices and other model plumbing codes, substantial cost reductions are possible. When combined with other innovative DWV practices, application of the CABO code plumbing section has resulted in lower-cost plumbing without compromising the health and safety of the dwelling occupants.

Water Service and Distribution

In the *CABO One and Two Family Dwelling Code*, acceptable water service materials include copper pipe or tube, galvanized steel, ABS, PVC, CPVC, polybutylene, polyethylene, or approved equivalents. Some local codes are more restrictive in specifying acceptable materials. The lack of competition in materials tends to keep the cost of the acceptable materials high. If for no other reason, a wide variety of competitive and acceptable materials is desirable for affordable housing.

CABO One and Two Family Dwelling Code Language

Materials: *Water-service pipe to point of entrance shall be:*

Copper pipe or tube.

Galvanized steel.

ABS, PVC, or CPVC plastic.

Polyethylene plastic.

Polybutylene plastic.

Other approved equivalents.

Minimum working pressure rating for piping shall be 160 psi at 73 degrees F. Fittings shall be approved and compatible with the type of piping used.

Source: *CABO One and Two Family Dwelling Code*, Section P-2403.1, 1989.

CABO One and Two Family Dwelling Code Language

Materials: *Water-distribution piping within dwelling units shall be:*

Copper pipe or tube.

Galvanized steel.

ABS or PVC plastic -- cold water only.

CPVC plastic -- hot or cold water.

Polyethylene plastic -- cold water only.

Polybutylene plastic -- hot or cold water.

Other approved equivalents.

Minimum working pressure rating for hot water piping shall be 100 psi at 180 degrees F. Fittings shall be approved and compatible with the type of piping being used.

Source: *CABO One and Two Family Dwelling Code*, Section P-2406.1, 1989.

Individual fixture stops are considered optional for single-family housing in Section P-2405.3 of the CABO code. Experience has shown that individual fixture stops sometimes deteriorate between time of installation and time of their eventual use to the degree that they may require replacement when they are most needed. They also add to the potential sources of water supply leaks. The possible convenience is offset by the equally possible inconvenience and added cost. In any event, convenience-only items should not be codified.

CABO One and Two Family Dwelling Code Language

Individual fixture, riser, and branch valves: Valves or stops to individual fixtures, appliances, risers, and branches may be installed, but are not required. Where installed, such valves or stops shall be accessible.

Source: CABO One and Two Family Dwelling Code, Section P-2405.3, 1989.

The water supply fixture unit (w.s.f.u.) values in the 1989 CABO code provide for selection of pipe sizes based on reasonable estimates of peak demands. Measurements in numerous field and laboratory tests have confirmed the validity of these values. The minimum size of **fixture water supply pipes** for all fixtures except dishwashers and lavatories

CABO One and Two Family Dwelling Code Language

MINIMUM SIZE OF FIXTURE BRANCHES

*(Fixture Water Supply Pipes)**

<u>Type of Fixture or Outlet</u>	<u>Nominal Pipe Size (in.)</u>
Bathtub (with or without shower head)	3/8
Clothes-washer supply fitting	3/8
Kitchen sink**	3/8
Laundry tub (one or two compartments)	3/8
Shower head	3/8
Wall hydrant/sill cock/hose bib	3/8
Dishwasher	1/4
Lavatory	1/4
Water closet (close-coupled tank type)***	1/4

**Table applies to water-conserving fixtures and supply fittings having branches not greater than 10 feet in length. If length is greater than 10 feet, increase one pipe size. For special fixtures or fittings, size according to manufacturer's recommendations.*

***Cold branch may be 1/4."*

****Or according to manufacturer's specifications.*

Source: CABO One and Two Family Dwelling Code, Section P-2406.4, 1989.

Construction and Building Codes

is 3/8-inch in the CABO code. For dishwashers and lavatories, the minimum size is 1/4 inch.

Fixture group main sizes are either 3/8 inch or 1/2 inch depending on the number and size of fixture branch pipes connected (Section P-2406.5). The CABO code also recognizes the different **flow rates** of different pipe materials and varies.

The significance of the *CABO One and Two Family Dwelling Code* cannot be overstated since studies have shown that a total cost reduction in supply piping of as much as 24 percent can be realized when compared to traditional plumbing systems.

Water heaters

Smaller homes intended for smaller families do not need large water heaters. Thirty-gallon gas or 30- to 40-gallon electric water heaters are generally adequate. Water heaters with a five-year warranty cost about \$20 less than units with a 10-year warranty. The differential often reflects the cost of an additional five-year service insurance policy, not the basic construction of the water heater.

Electrical

Electrical codes and their application are normally not flexible. Even so, electrical wiring costs can be safely reduced by several methods while still meeting the intent of the electrical codes.

During the design phase, **reduction of length of wiring** can be planned. For example, open, multiuse areas are considered desirable in smaller homes. Because most codes require one duplex receptacle for each 12 feet of wall, open spaces that eliminate walls or reduce their length will reduce the number of receptacles required. If a receptacle is needed to reduce the possibility of electrical cords crossing door openings, moving the door might eliminate the need for the receptacle. **Relocate closet doors or other openings** to avoid short walls over 24 inches wide that will require an outlet. Check the house during construction to ensure that extra outlets are not arbitrarily installed.

During design, consider **clustering heavy appliance circuits** near the distribution panel to minimize runs of expensive heavy cable. If this arrangement is possible, the electrical subcontractor's bid should reflect this cost-saving design feature. The range, clothes dryer, water heater, electric furnace/air conditioner or heat pump require **240-volt circuits**. The lengths of expensive, heavier cable can be reduced by paying attention to the location of this equipment during design. In addition, if the furnace is located near the breaker panel, a separate disconnect switch is not required.

In some locations, entire homes are wired with #12 wire and 20-amp devices for general wiring, although most codes allow much of the house to be wired with **#14 wire and 15-amp devices**. For affordable housing, the least expensive yet acceptable wiring approach should be used. Smaller homes do not need heavy service load centers; many can be served by a **100-amp load center**.

Extra branch circuits are often routinely installed by electricians to simplify the arrangement of breakers in the panel. By **maximizing the number of devices on a circuit**, one or two circuits per dwelling unit can often be eliminated. **Plastic utility boxes and junction boxes**, which are allowed by most codes, will reduce costs at each wiring point.

Heating, Ventilation, and Air Conditioning

Because heating, ventilation, and air conditioning (HVAC) system design is complex, judgments on system size and location of ducts, if any, should be left to the experts. But builders should understand some fundamentals before selecting the most appropriate system according to home design, fuel availability, market preference, and costs of installation and maintenance. If a ducted system is to be used, a manual entitled *Residential Duct Systems* (available from the National Association of Home Builders, 15th & M Streets, NW, Washington, DC 20005) is useful in describing the most efficient ducting methods according to fuel, type of equipment, operating efficiencies, and relative cost.

Construction and Building Codes

Design starts with accurate heat loss and heat gain calculations as the only rational basis for selecting equipment and designing the system. For affordable housing, equipment selected on the basis of experience and judgment is often oversized and inefficient. The HVAC system should recognize the uniqueness of each home and be designed accordingly. The standard calculation procedure for heat loss and gain is found in *Manual J, Load Calculation for Residential Winter and Summer Air Conditioning*.¹³

Avoid the tendency to oversize HVAC equipment. Some believe that if equipment of a certain size is adequate based on proper calculation, a size larger will be even more desirable and will guard against unexpected conditions. Further, because incremental costs of upsizing appear not to be excessive in most cases, it is tempting to oversize. However, equipment sized according to sound heat loss/gain calculations almost always operates more efficiently and uniformly than oversized units. In addition, **downsized or redesigned duct systems** may be possible in energy-efficient homes designed with smaller HVAC equipment that maintains proper air velocity and flow.

¹³ Available from the Air Conditioning Contractors of America, 1228 17th St., NW, Washington, DC 20036.

In small, single-story housing units with a central hall that abuts all living areas, a **dropped-hall ceiling plenum** works well at minimum cost. In this system, the hall ceiling and walls are drywalled, taped, and spackled as usual. Then another ceiling, dropped six to eight inches below the conventional ceiling is framed and drywalled, providing a plenum or "gypsum duct" for air distribution. High inside wall registers to each room are connected to the plenum by a short metal boot. Although the system has worked well in many installations without ductwork, some codes or inspectors may insist on ducts within the ceiling cavity. Even so, the system is usually cost-effective. The *CABO One and Two Family Dwelling Code* permits plenum systems (Section M-1601.1) that accommodate low-output temperature equipment up to 125 degrees F., including most heat pumps and electric furnaces. Fossil-fueled equipment generally exceeds this temperature limit.

Dropped hall ceiling

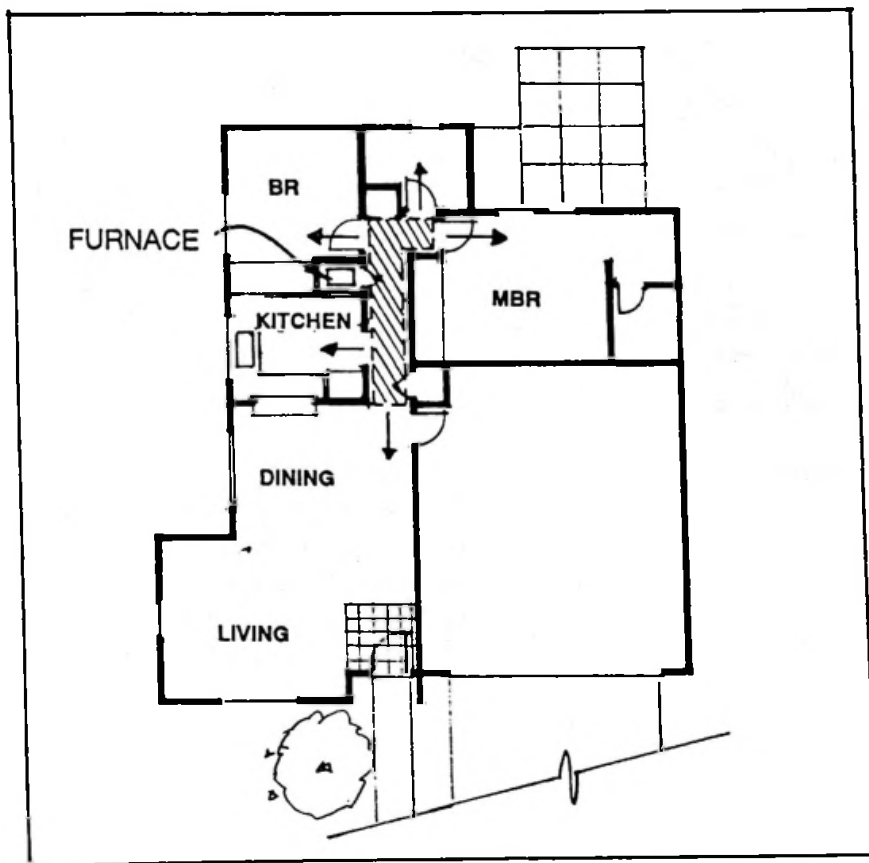

Radial duct systems are often the simplest systems to install. Branch ducts connect directly to the equipment plenum without trucks. Radial systems are typically installed where it is not necessary to conceal the duct work and where the equipment is somewhat centrally located. The simplicity of the system provides labor and material cost savings when compared to most other approaches to duct installation.

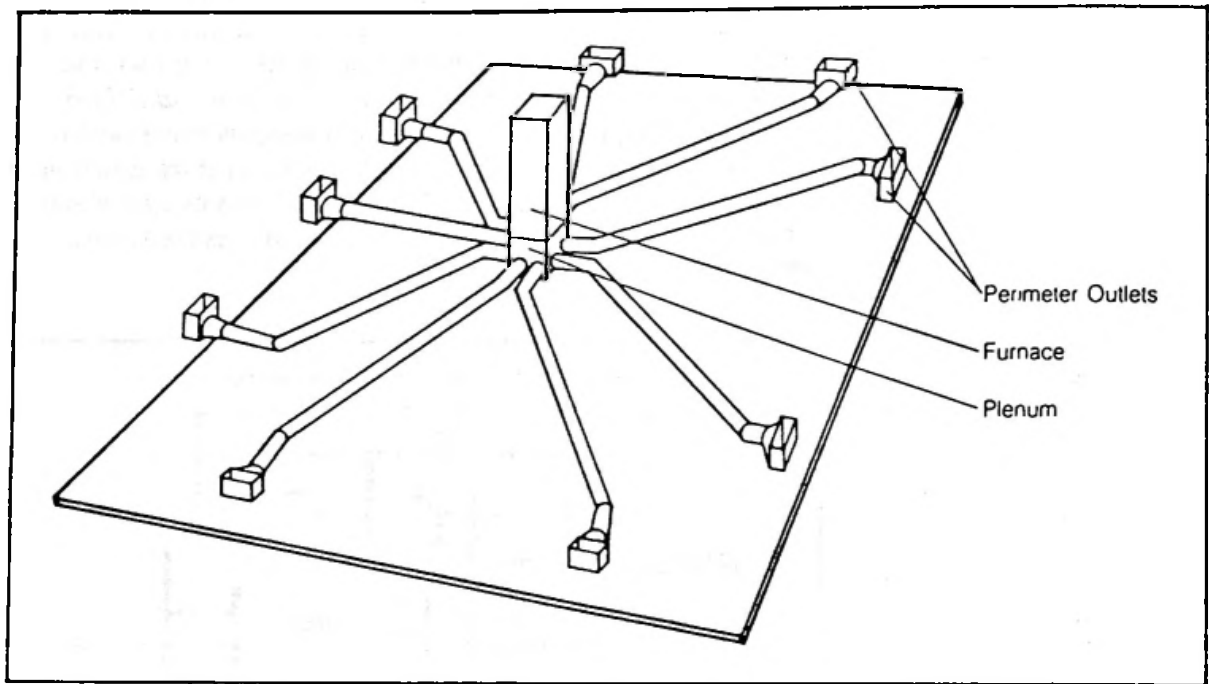

Radial duct

Electric baseboard heat with individual room thermostats offers significant construction cost savings in smaller, well-insulated homes where central air conditioning is not required. Depending on relative costs of alternative fuels, electric baseboard heating may offer operating cost savings because of the ability to zone heat the house.

An innovative heating and cooling system that has enjoyed some regional success is the **Plenwood** or **underfloor heating/cooling plenum**. In this system, the entire underfloor (crawl space) area is used as a sealed-plenum chamber to distribute conditioned air to floor registers in the rooms above. A downflow forced air heating and/or cooling unit maintains slight positive pressure in the underfloor area, thereby ensuring uniform air distribution throughout the home with few if any supply ducts. As an alternative, the underfloor area has been used as a return air plenum in some installations.¹⁴

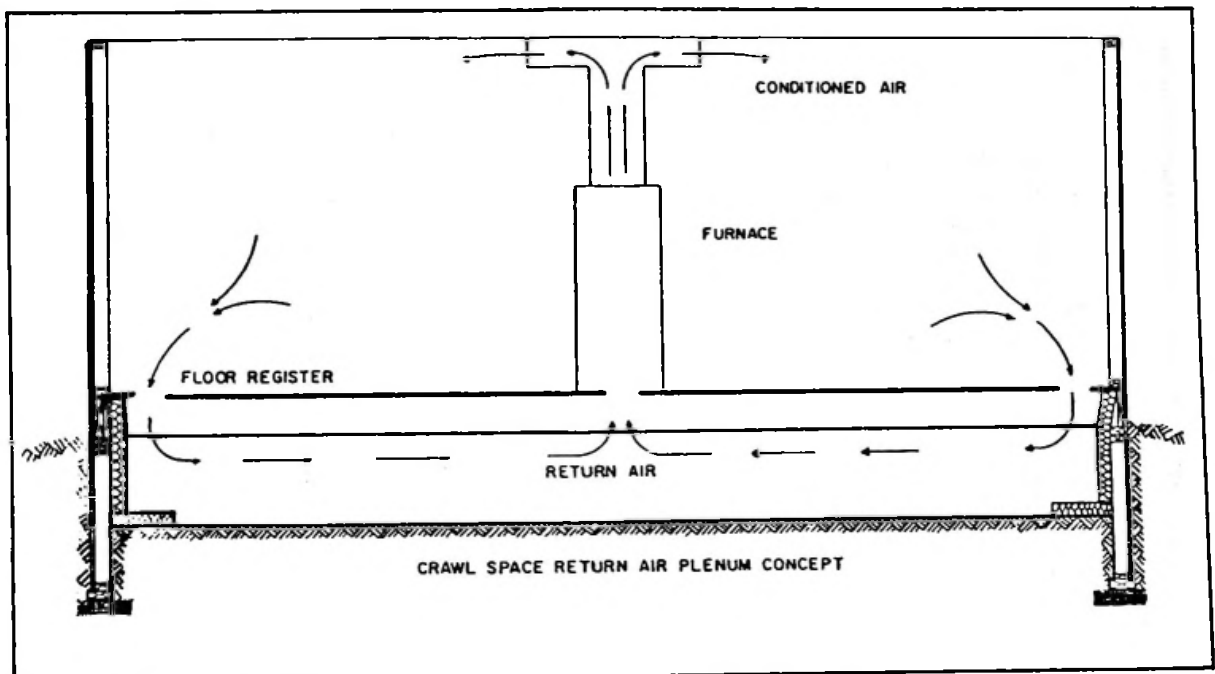

Underfloor plenum

¹⁴ More information is available from the American Plywood Association, P.O. Box 11700, Tacoma, WA 98411.

CABO One and Two Family Dwelling Code Language

Underfloor plenum for a single-dwelling unit: An underfloor space may be used as a supply plenum, provided:

- 1. Such spaces shall be cleaned of all loose combustibile scrap material and shall be tightly and substantially enclosed.*
- 2. The enclosing material of the underfloor space, including the sidewall insulation, shall be not more flammable than 1-inch (nominal) wood boards (flame spread classification of 200). Installation of foam plastics is regulated as in Section R-216.1 of the CABO One and Two Family Dwelling Code.*
- 3. Access shall be through an opening in the floor and shall be 18 inches by 24 inches.*
- 4. The furnace supplying warm air to such space shall be equipped with an automatic control which will start the air-circulating fan when the air in the furnace bonnet reaches a temperature not higher than 150 degrees F.*
- 5. The furnace supplying warm air to such space shall be equipped with an approved temperature-limit control that will limit outlet air temperature to 200 degrees F.*
- 6. A noncombustible receptacle shall be placed below each floor opening into the plenum and such receptacle shall conform to the following:*
 - a. The receptacle shall be securely suspended from the floor members and shall be not more than 18 inches below the floor opening.*
 - b. The area of the receptacle shall extend 3 inches beyond the opening on all sides.*
 - c. The perimeter of the receptacle shall have a vertical lip at least 1 inch high at the open sides if it is at the level of the bottom of the floor joists, or 3 inches high if the receptacle is suspended.*
- 7. Floor registers shall be designed for easy removal in order to give access for cleaning the receptacles.*
- 8. A duct shall extend from the furnace-supply outlet at least 6 inches below combustibile framing.*
- 9. The entire ground surface of the underfloor space shall be covered with a vapor barrier having a maximum permeability rating of 1 perm.*
- 10. Fuel gas lines and plumbing waste cleanouts shall not be located within the space.*

Source: CABO One and Two Family Dwelling Code, Section M-1604, 1989.

REHABILITATION

Introduction

The alternative to construction of new homes and apartments is to remodel or rehabilitate existing units. Of the over 100 million dwelling units in the United States, many are considered "substandard" and some are vacant because of disrepair. In addition, millions of square feet of commercial and institutional floor space are available for conversion into low- and moderate-income housing. Outmigration from inner cities, especially along the east coast, has created an abundance of boarded-up housing that could be rehabilitated into moderately priced rental and for-sale units. The loss of tax revenues from these units has created substantial revenue drains in some communities.

Acquiring Property for Rehabilitation

The keys to successful rehabilitation/remodeling of existing units are

- knowing the local market
- understanding the cost parameters to meet the market
- finding the right properties

The value of a property relates to location, market conditions, and the physical condition of the property. For affordable housing, it is important to locate inexpensive properties that have excellent potential for rehabilitation at low cost within an area where people want to live. Before gaining control of a property, it is essential to find out if it is worth acquiring. Usually, the longer a property has been vacant, the higher the cost of rehabilitation. It is also important to know if the property is zoned for residential use, is free of ownership controversy, and is likely to remain affordable within available financing options. Inspection and evaluation of the potential rehabilitation cost is necessary.

Institutions such as churches, universities, and hospitals often own substandard properties. Local government agencies frequently own surplus properties such as vacant schools and

tax-foreclosed housing units. HUD, the Department of Veteran Affairs, and the Farmers Home Administration all own properties that have been foreclosed. In addition, foreclosures by private lenders often present opportunities for remodeling or rehabilitating units at low cost for resale. Estate sales and Internal Revenue Service tax liens are other sources of housing units that may be available.

In many cases, the local government has eminent domain "quick-take" authority. In general, this authority allows a government to pay the owner the appraised price for a property and take title to it in a relatively short period of time. Purposes for which a local government may condemn and take or buy private property include

- implementing an urban renewal plan
- alleviating a health hazard
- eliminating blight
- providing property for low-income housing

This approach to property acquisition is especially useful when current ownership is unclear or when multiple owners cannot agree on the disposition of property.

Economic Analysis

An analysis of the affordability of a prospective property must be based on at least the following information:

- source(s) of funds
- cost estimate of property purchase, rehabilitation, and development
- projected rental income
- tenant relocation costs, if any
- estimated operating costs of rental units

According to *The Cost Cuts Manual*¹⁵, a publication of The Enterprise Foundation's Rehab Work Group, "Successful low-cost renovations mean fixing what is fixable, replacing what is broken (beyond repair), and adding only what is necessary to

¹⁵ *The Cost Cuts Manual, Nailing Down Savings for Least-Cost Housing*, The Rehab Work Group, 500 American City Building, Columbia, MD 21044.

reduce costs for energy, maintenance, and repair." In other words, indiscriminately ripping out the old and replacing with new often results in excessively costly renovation. By analyzing each component of a building with an eye toward saving rather than replacing the component, costs can be minimized. By adopting this philosophy, renovators will find that many more units can be revitalized with a fixed amount of money.

In addition, most building codes require that new work must conform to the standards for new housing, while old work can be left in place if it meets the housing and zoning codes. Varying regulatory provisions for new construction, thereby and rehabilitation might make the difference in making a renovation project financially feasible. For example, in some narrow rowhouses, stair widths allow easy passage in hallways around the stairwell. If stairs are replaced, they must often be widened to meet housing codes for new construction, thereby making adjacent hallways too narrow for use. In another example, one duplex electrical outlet can be added to existing wiring; but if wiring is replaced, the new construction code might require many new outlets, several additional circuits, and an upgraded service entry panel.

Serious code violations such as bare electrical wires, faulty heating systems, and deficient plumbing must, of course, be repaired or replaced. On the other hand, if the total cost of rehabilitation is too expensive because of code requirements, millions of Americans are forced to live in units that seriously compromise health and safety. Finding the right balance between need and cost feasibility is the goal of affordable rehabilitation.

Single Room Occupancy

There is a growing need for low-cost housing for employed people who are homeless. One solution is the single room occupancy (SRO) hotel. Over the past 10 years, SROs have increasingly served as affordable housing for many low-income singles and couples. Although their image remains disreputable in some areas, SROs are generally gaining widespread acceptance as a housing alternative.

Rehabilitation

Many cities throughout the country are experiencing an increase in the use of overnight emergency shelters by the working poor. To address this one aspect of the homelessness problem, some communities are examining new solutions for housing single people and couples with limited incomes. Some are encouraging remodeling of existing residential hotels and development of new SROs.

As with any type of housing, SRO development starts with an assessment of supply and demand. Each community is different in terms of what kind of housing it can support. For example, San Diego is a large, growing city with an expanding number of single-person households and high median rents. The city is a good market for SROs for low- and moderate-income singles and couples. On the other hand, slower-growth cities with lower market-rate rents may find that the market for SROs is limited.

Some cities allow SROs only in established commercial and industrial areas. These sites are particularly well suited for SRO housing because of their proximity to both employment centers and public transportation and because of the reduced likelihood of public resistance. Rehabilitation of older hotels and rooming houses is usually the most economic method of providing SROs. Zoning is almost always already in place, and communities often view rehabilitation of potential SRO buildings as an attractive part of community redevelopment.

The city of San Diego is one of the leaders in the development of SROs. The city's goal is to encourage private development and management of SROs as profit-making ventures by amending building regulations and codes to allow lower construction and operation costs that are passed on to tenants in the form of lower rents. From April 1987 through the end of 1990, San Diego builders added a total of nearly 2,000 SRO rooms to downtown San Diego.

SROs have proven to be an affordable housing answer for a small percentage of the population. They have helped provide stability for the marginally employed. Although some occupants prefer to move to other housing as their financial situation improves, SROs are not necessarily "temporary" residences. Some occupants, no doubt, prefer to stay for

extended periods of time. Therefore, SROs should be rented and managed in a manner similar to conventional apartments.

Case Study

The city of San Diego passed measures that, among other things,

- require replacement of converted or demolished SROs when the total number of units falls below a 1985 threshold
- provide benefits and rights of financial and technical assistance to permanent residents of residential hotels that are to be demolished or converted
- adopt a housing commission action plan calling for 500 new SRO rooms and the rehabilitation of 300 SRO rooms
- direct the building and fire inspection departments to expedite development and conversion of SRO hotels to mixed-use projects
- develop financial incentives to discourage owners from seeking a change of use
- support housing commission rehabilitation subsidies and assistance to counteract any increases in rents resulting from SRO renovations
- direct the water department to study the use of water in SROs and to develop sewer connection and capacity charge rates that fairly reflect usage

The city of San Diego advocated the following code and regulation changes:

- creation of a new definition of "living unit" that includes a minimum of 150 square feet and an incomplete kitchen or bathroom and that is restricted to one or two people
- creation of an SRO and studio apartment hybrid, allowed in residential areas with rent restrictions and parking requirements
- sprinkler systems in all new or rehabilitated SROs with accompanying reductions in other fire-related code requirements
- determination of the need for elevators by the market rather than by regulation
- mechanical ventilation rather than air intake systems
- metallic Romex cable on all floors of the building
- interpretation of SROs as hotels in the zoning code for meeting disability access requirements
- reduced parking (0.2 spaces per unit) in downtown developments and negotiated parking requirements outside of downtown

1918

Department of Agriculture
Bureau of Plant Industry

Washington, D. C.

Dear Sir:

I have the honor to acknowledge the receipt of your letter of the 10th inst. in relation to the matter mentioned therein.

The Bureau is pleased to hear that you are interested in the work of the Bureau and that you are desirous of securing information regarding the same.

The Bureau is engaged in a number of important projects and is constantly endeavoring to advance the interests of the agricultural industry.

Very truly yours,
 Director

BIBLIOGRAPHY

"Affordable Housing Bulletin", Boston, MA: Warren, Gorham & Lamont, Inc.

American Planning Association, *Streamlining Land Use Regulation*, Chicago, IL: American Planning Association, 1980.

American Society of Civil Engineers, *Residential Streets, Second Edition*, Washington, DC: American Society of Civil Engineers, National Association of Home Builders, and Urban Land Institute, 1990.

American Society of Civil Engineers, *Residential Storm Water Management - Objectives, Principles, and Design Considerations*, Washington, DC: American Society of Civil Engineers, National Association of Home Builders, and Urban Land Institute, 1975.

Apgar, William, *The State of the Nation's Housing, 1990*, Cambridge, MA: Joint Center for Housing Studies, Harvard University, 1990.

Bucks County Planning Commission, *Performance Streets, A Concept and Model Standards for Residential Streets*, Doylestown, PA: Bucks County Planning Commission, 1980.

Center for Community Development and Preservation, *Affordable Housing, Public and Private Partnerships for Constructing Middle and Moderate Income Housing*, White Plains, NY: Center for Community Development and Preservation, 1980.

Center For Public Dialogue, *Affordable Housing, A Missing Link*, Kensington, MD: Center for Public Dialogue, 1988.

Collie Planning and Development Services, *New Choices in Housing, Guidelines for Cost-Effective Residential Land Development*, Canberra ACT 2601, Commonwealth of Australia, 1989.

Council of American Building Officials, *CABO One and Two Family Dwelling Code*, Falls Church, VA: Council of American Building Officials, 1989.

Council of State Community Affairs Agencies, *State Actions for Affordable Housing*, Washington, DC: U.S. Department of Housing and Urban Development and Council of State Community Affairs Agencies, 1982.

Fisher, E. Lee, *An Approach for the 80's: Affordable Housing Demonstration Program*, Washington, DC: U.S. Department of Housing and Urban Development, 1981.

Fisher, E. Lee, *Building Affordable Homes, A Cost Savings Guide for Builder/Developers*, Washington DC: U.S. Department of Housing and Urban Development and The National Association of Home Builders, 1983.

Fisher, E. Lee, *Challenge and Response - Volume II, Affordable Residential Construction*, Washington DC: U.S. Department of Housing and Urban Development and NAHB National Research Center, 1987.

Gutteridge Haskins & Davey Pty Ltd, *Research Study Into Siting Related Issues of Residential Development*, Canberra ACT 2601, Australia: Commonwealth of Australia, 1989.

International City Management Association, *Streamlining Local Regulations, A Handbook for Reducing Housing and Development Costs*, Washington, DC: U.S. Department of Housing and Urban Development and International City Management Association, 1983.

Jansen, David R., *Zero Lot Line Housing*, Washington, DC: Urban Land Institute, 1981.

Listokin, David and Carole Walker, *The Subdivision and Site Plan Handbook*, New Brunswick, NJ: The State University of New Jersey, Rutgers, 1989.

Luebs, Donald F., *Reducing Home Building Costs With OVE Design and Construction*, Upper Marlboro, MD: NAHB National Research Center, 1972.

Model Code Task Force of the Joint Venture for More Affordable Housing, *Australian Model Code for Residential Development*, Canberra, ACT 2601, Australia: Australian Government Publishing Service, 1989.

National Association of Home Builders, *Building Better Communities Through Regulatory Reform*, Washington, DC: National Association of Home Builders, 1985.

National Association of Home Builders, *Building Together, Investing in Community Infrastructure*, Washington, DC: National Association of Home Builders, 1990.

National Association of Home Builders, *Density Development, Cost-Effective and Affordable*, Washington, DC: National Association of Home Builders, 1982.

National Association of Home Builders, *Land Use and Construction Regulations, A Builder's View*, Washington, DC: National Association of Home Builders, 1982.

National Association of Home Builders, *Low- and Moderate-Income Housing: Progress, Problems and Prospects*, Washington, DC: National Association of Home Builders, 1986.

NAHB National Research Center, *Manual of Plywood and Lumber Savings Techniques*, Upper Marlboro, MD: NAHB National Research Center, 1978.

National Bureau of Standards, *Estimating Economic Impacts of Building Codes*, Washington, DC: U.S. Department of Commerce, 1981.

National Center for Housing Management, *Tools and Techniques for Housing Development, A Guidebook for Local Officials*, Washington, DC: National Center for Housing Management, 1983.

Pak-Poy and Kneebone Pty Ltd, *Research Study into Road Characteristics for Residential Development*, Canberra, ACT 2601, Australia: Australian Department of Industry, Technology and Commerce, 1989.

Regal, Stuart and Stevenson Weitz, *Land for Housing, How Local Governments Can Help Increase Supply*, Washington, DC: The Urban Land Institute, 1984.

Rehab Work Group, *The Cost Cuts Manual*, Columbia, MD: The Enterprise Foundation, 1987.

Santucci, Robert M., Brooke C. Stoddard, and Peter Werwath, *A Consumer's Guide to Home Improvement, Renovation & Repair*, John Wiley & Sons, 1990.

Schaake, Carol B., *Challenge and Response - Volume I, Affordable Residential Land Development, A Guide for Local Government and Developers*, Washington, DC: U.S. Department of Housing and Urban Development and NAHB National Research Center, 1987.

Shelterforce, "Coming of Age, Employee Assisted Housing", New Brunswick, NJ: Rutgers University, Jan/Feb 1990.

Urban Land Institute, *Housing Supply and Affordability*, Washington, DC: Urban Land Institute, 1983.

Urban Land Institute, *PUDs In Practice*, Washington, DC: Urban Land Institute, 1983.

Urban Land Institute, *Working With the Community: A Developer's Guide*, Washington, DC: Urban Land Institute, 1985.

U.S. Department of Housing and Urban Development, *Final Report of the Task Force on Housing Costs*, Washington, DC: U.S. Department of Housing and Urban Development, 1978.

U.S. Department of Housing and Urban Development, *Innovative Site Utility Installation*, Washington, DC: U.S. Department of Housing and Urban Development, 1983.

U.S. Department of Housing and Urban Development, *Tools and Techniques for Housing Development, A Guidebook for Local Officials*, Washington, DC: U.S. Department of Housing and Urban Development, 1983.

Weitz, Stevenson, *Affordable Housing: How Local Regulatory Improvements Can Help*, Washington, DC: U.S. Department of Housing and Urban Development, 1982.

Yingling, Ronald K., *Residential Plumbing Guidelines*, Upper Marlboro, MD: NAHB National Research Center, 1986.



U.S. Department of Housing and Urban Development
Washington, D.C. 20410-6000
Official Business
Penalty for Private Use \$300

February 1992
HUD-PDR-1343

